

回路図 AE-CAP-ARRAY100-SIP(226)

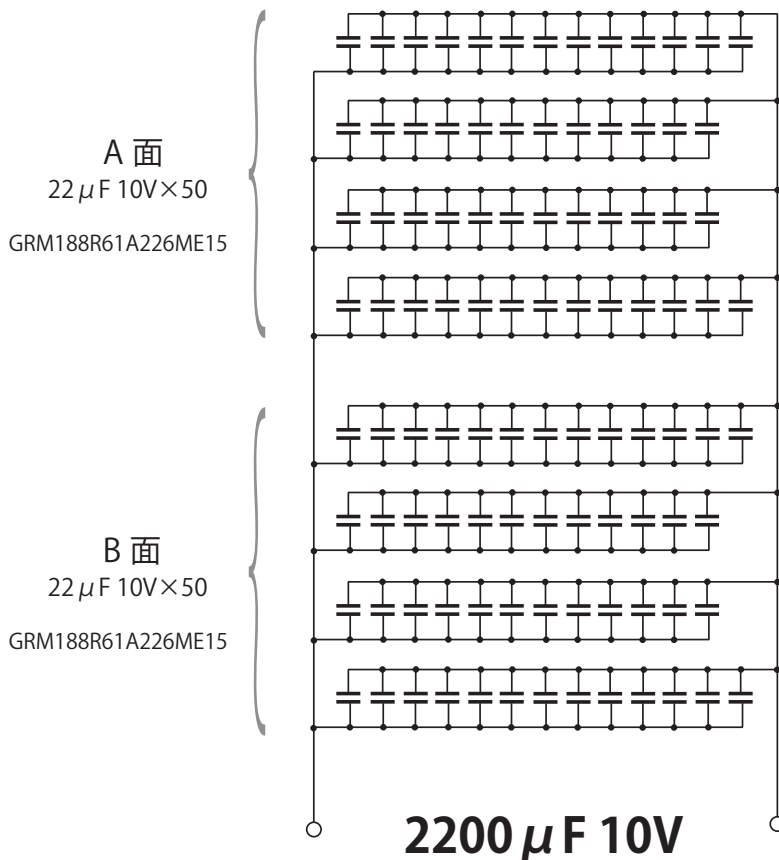

コンデンサの仕様 GRM188R61A226ME15#



形状

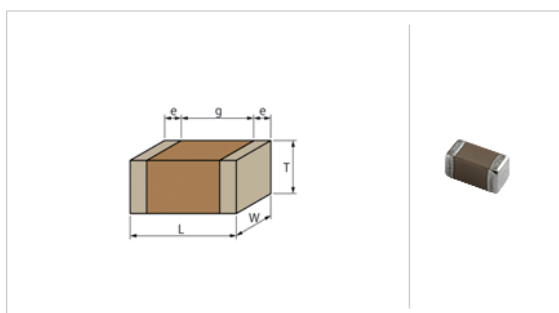

L寸法	1.6 ±0.2mm
W寸法	0.8 ±0.2mm
T寸法	0.8 ±0.2mm
外部電極幅e	0.2~0.55mm
外部電極間距離g	0.6mm min.
サイズコード mm	1608

スペック

静電容量	22 μ F ±20%
定格電圧	10Vdc
温度特性 (準規規格)	X5R(EIA)
静電容量変化率	±15.0%
温度特性の温度範囲	-55~85°C

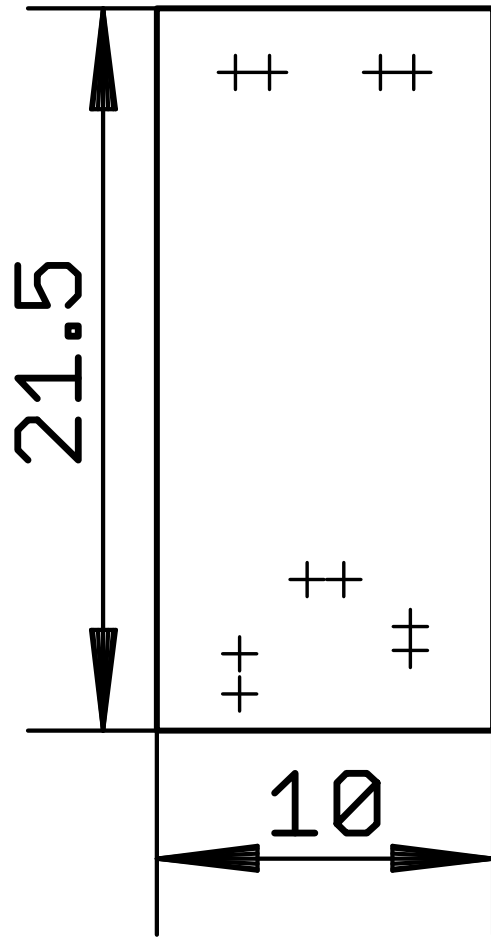

Sym	T#	mm	TH/NTH	Qty
+	1	0.30	TH	10

CAP-ARRAY100-SIP(1608)

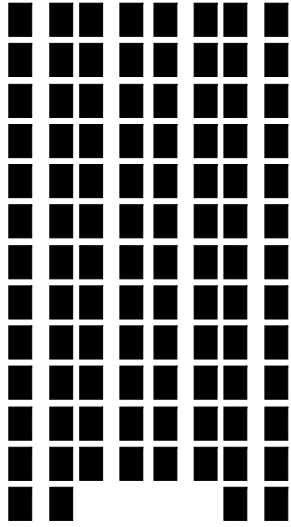

C18
100

CAP-ARRAY100-SIP<1608>
TOP-SOLDERMASK

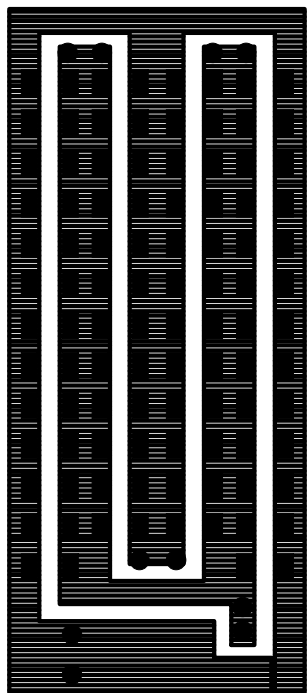

CAP-ARRAY100-SIP<1608>

TOP

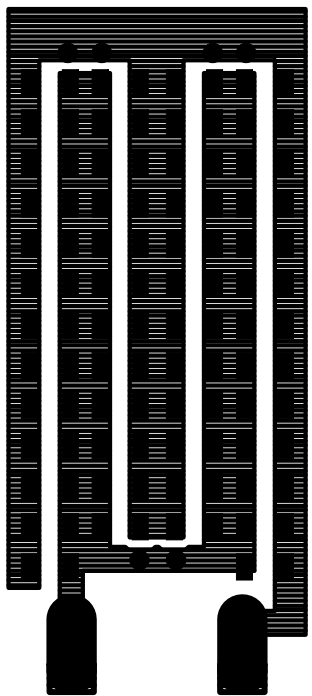

CAP-ARRAY100-2IP(1P08)
BOTTOM

001x80210

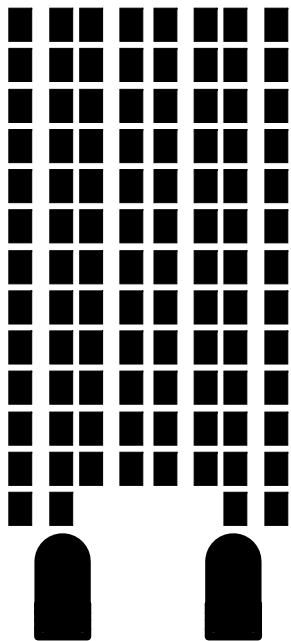

САР-АРРАУ100-21Р(108)
ВОТТОМ-20LDERMA2K

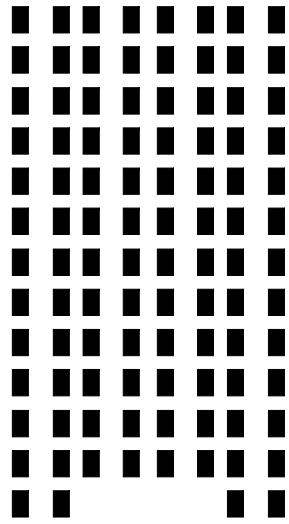

CAP-ARRAY100-SIP(1608)
TOP-METALMASK

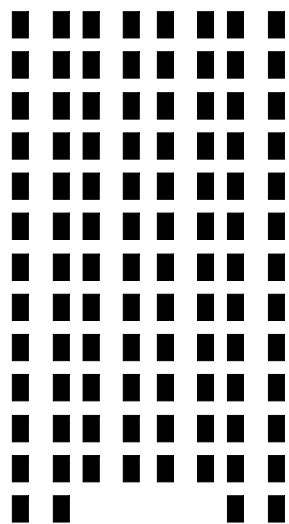

САР-АРРАУ100-0012-001(1908)
БОТТОМ-МЕТАЛМАСК