



# 2SD468

## NPN SILICON TRANSISTOR

### LOW FREQUENCY POWER AMPLIFIER

■ FEATURES

- \* Low frequency power amplifier
- \* Complement to 2SB562

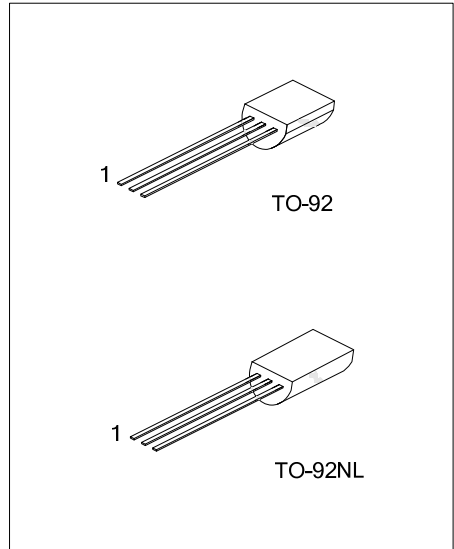

■ ORDERING INFORMATION

Ordering Number		Package	Pin Assignment			Packing
Lead Free	Halogen Free		1	2	3	
2SD468L-x-T92-B	2SD468G-x-T92-B	TO-92	E	C	B	Tape Box
2SD468L-x-T92-K	2SD468G-x-T92-K	TO-92	E	C	B	Bulk
2SD468L-x-T9N-B	2SD468G-x-T9N-B	TO-92NL	E	C	B	Tape Box
2SD468L-x-T9N-K	2SD468G-x-T9N-K	TO-92NL	E	C	B	Bulk

Note: Pin Assignment: E: Emitter C: Collector B: Base

<p>2SD468L-x-T92-B</p>	<p>(1) B: Tape Box, K: Bulk                  (2) T92: TO-92, T9N: TO-92NL                  (3) x: refer to Classification of <math>h_{FE}</math>                  (4) L: Lead Free, G: Halogen Free and Lead Free</p>
------------------------	---

■ MARKING

TO-92	TO-92NL

■ ABSOLUTE MAXIMUM RATINGS ( $T_A=25^\circ\text{C}$ , unless otherwise specified)

PARAMETER	SYMBOL	RATINGS	UNIT
Collector-Base Voltage	$V_{CBO}$	25	V
Collector-Emitter Voltage	$V_{CEO}$	20	V
Emitter-Base Voltage	$V_{EBO}$	5	V
Collector Current	$I_C$	1	A
Collector Peak Current	$I_{CP}$	1.5	A
Collector Power Dissipation	$P_C$	0.9	W
Junction Temperature	$T_J$	+150	$^\circ\text{C}$
Storage Temperature	$T_{STG}$	-55 ~ +150	$^\circ\text{C}$

Note: Absolute maximum ratings are those values beyond which the device could be permanently damaged. Absolute maximum ratings are stress ratings only and functional device operation is not implied.

■ ELECTRICAL CHARACTERISTICS ( $T_A=25^\circ\text{C}$ , unless otherwise specified)

PARAMETER	SYMBOL	TEST CONDITIONS	MIN	TYP	MAX	UNIT
Collector-Base Breakdown Voltage	$BV_{CBO}$	$I_C=10\mu\text{A}$ , $I_E=0$	25			V
Collector-Emitter Breakdown Voltage	$BV_{CEO}$	$I_C=1\text{mA}$ , $R_{BE}=\infty$	20			V
Emitter-Base Breakdown Voltage	$BV_{EBO}$	$I_E=10\mu\text{A}$ , $I_C=0$	5			V
Collector Cut-Off Current	$I_{CBO}$	$V_{CB}=20\text{V}$ , $I_E=0$			1	$\mu\text{A}$
DC Current Transfer Ratio	$h_{FE}$	$V_{CE}=2\text{V}$ , $I_C=0.5\text{A}$ (Note)	85		240	
Collector-Emitter Saturation Voltage	$V_{CE(SAT)}$	$I_C=0.8\text{A}$ , $I_B=0.08\text{A}$ (Note)		0.2	0.5	V
Base-Emitter Voltage	$V_{BE}$	$V_{CE}=2\text{V}$ , $I_C=0.5\text{A}$ (Note)		0.79	1	V
Gain Bandwidth Product	$f_T$	$V_{CE}=2\text{V}$ , $I_C=0.5\text{A}$ (Note)		190		MHz
Collector Output Capacitance	$C_{ob}$	$V_{CB}=10\text{V}$ , $I_E=0$ , $f=1\text{MHz}$		22		pF

Note: Pulse test

■ CLASSIFICATION OF  $h_{FE}$

RANK	B	C
RANGE	85 - 170	120 - 240

## ■ TYPICAL CHARACTERISTICS

Maximum Collector Dissipation Curve

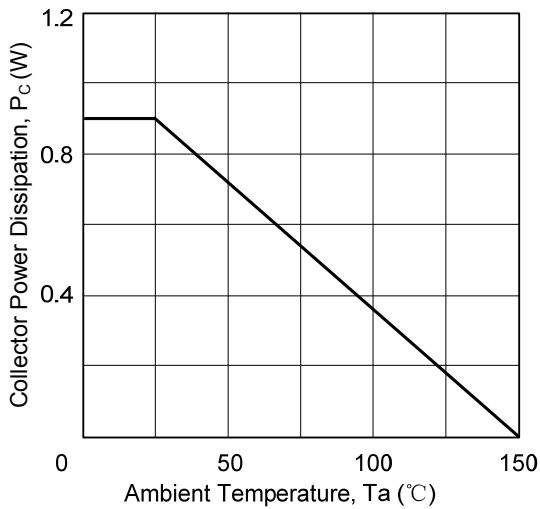

Typical Output Characteristics

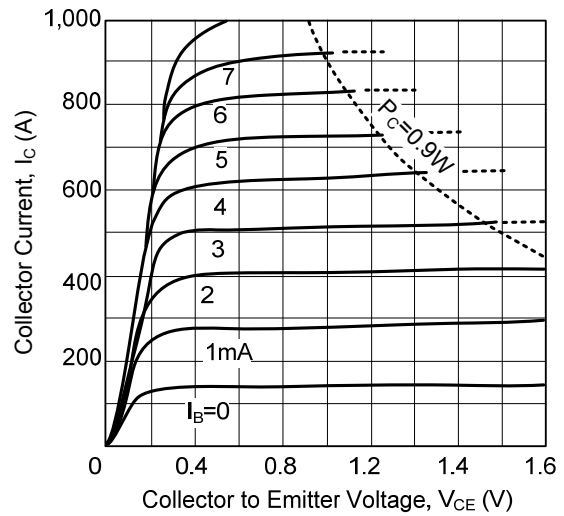

Typical Transfer Characteristics

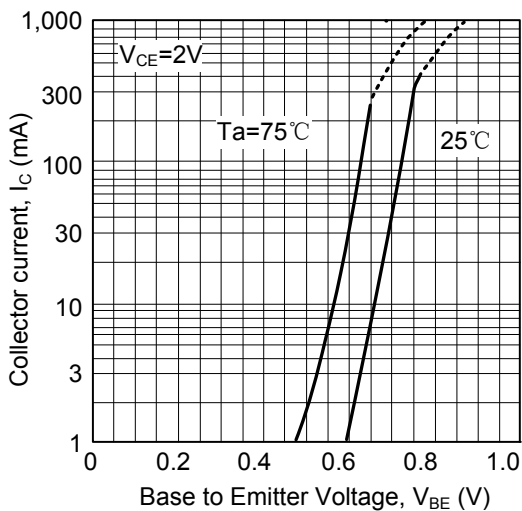

DC Current Transfer Ratio vs. Collector Current

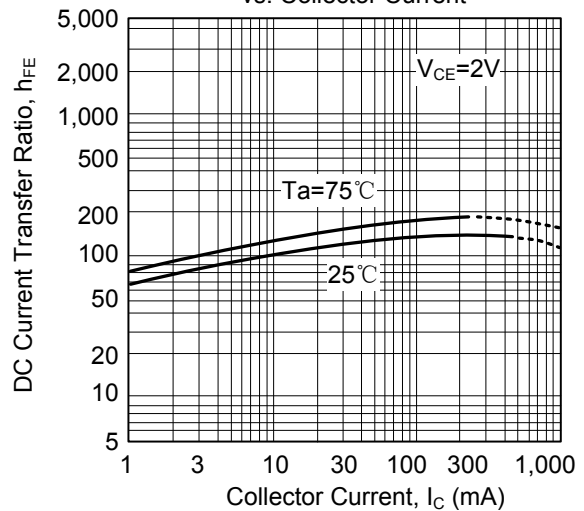

Collector to Emitter Saturation Voltage vs. Collector Current

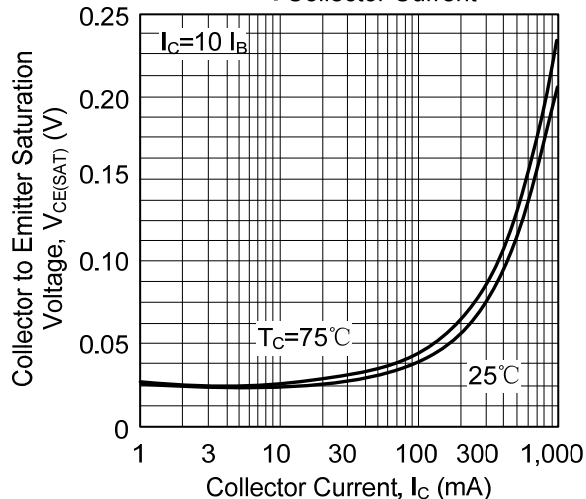

Gain Bandwidth Product vs. Collector Current

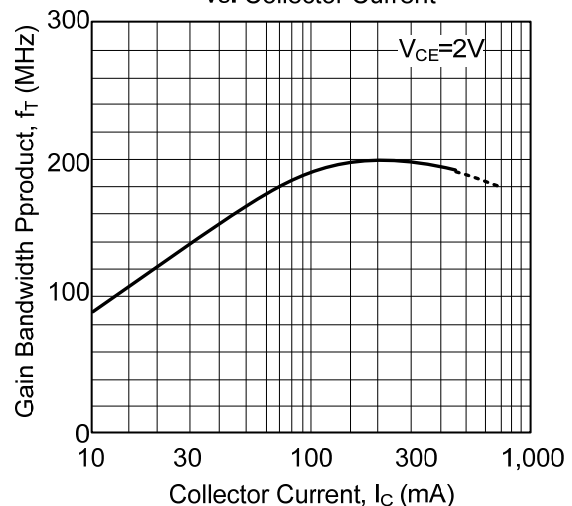

■ TYPICAL CHARACTERISTICS(Cont.)

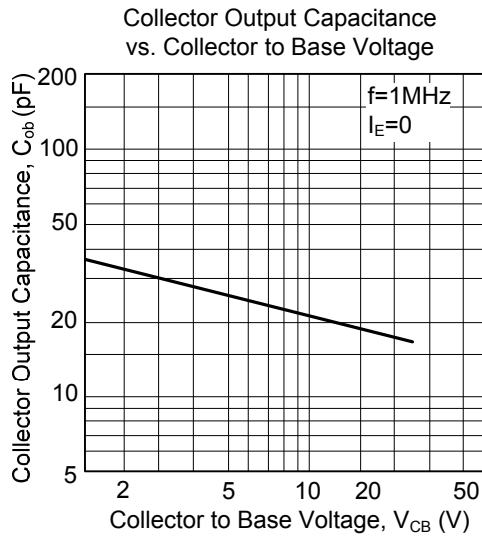

UTC assumes no responsibility for equipment failures that result from using products at values that exceed, even momentarily, rated values (such as maximum ratings, operating condition ranges, or other parameters) listed in products specifications of any and all UTC products described or contained herein. UTC products are not designed for use in life support appliances, devices or systems where malfunction of these products can be reasonably expected to result in personal injury. Reproduction in whole or in part is prohibited without the prior written consent of the copyright owner. The information presented in this document does not form part of any quotation or contract, is believed to be accurate and reliable and may be changed without notice.