

TO-92 Plastic-Encapsulate Transistors

2SA950 TRANSISTOR (PNP)

FEATURES

- 1W Output Applications
- Complementary to 2SC2120

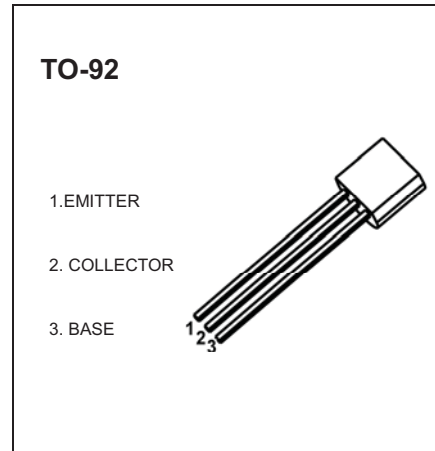

MARKING

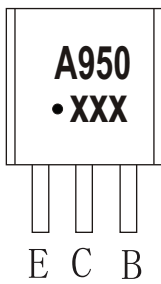

A950=Device code
Solid dot=Green molding compound device,
if none,the normal device
XXX=Code

Equivalent Circuit

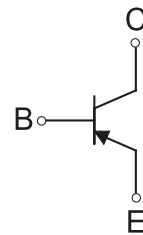

ORDERING INFORMATION

Part Number	Package	Packing Method	Pack Quantity
2SA950	TO-92	Bulk	1000pcs/Bag
2SA950-TA	TO-92	Tape	2000pcs/Box

MAXIMUM RATINGS (T_a=25°C unless otherwise noted)

Symbol	Parameter	Value	Unit
V _{CB0}	Collector-Base Voltage	-35	V
V _{CE0}	Collector-Emitter Voltage	-30	V
V _{EB0}	Emitter-Base Voltage	-5	V
I _c	Collector Current -Continuous	-0.8	A
P _D	Collector Power Dissipation	600	mW
R _{θJA}	Thermal Resistance from Junction to Ambient	208	°C /W
T _j	Junction Temperature	150	°C
T _{stg}	Storage Temperature	-55 ~+150	°C

ELECTRICAL CHARACTERISTICS

$T_a=25^\circ\text{C}$ unless otherwise specified

Parameter	Symbol	Test conditions	Min	Typ	Max	Unit
Collector-base breakdown voltage	$V_{(BR)CBO}$	$I_C = -0.1\text{mA}$, $I_E = 0$	-35			V
Collector-emitter breakdown voltage	$V_{(BR)CEO}$	$I_C = -10\text{mA}$, $I_B = 0$	-30			V
Emitter-base breakdown voltage	$V_{(BR)EBO}$	$I_E = -0.1\text{mA}$, $I_C = 0$	-5			V
Collector cut-off current	I_{CBO}	$V_{CB} = -35\text{V}$, $I_E = 0$			-0.1	μA
Emitter cut-off current	I_{EBO}	$V_{EB} = -5\text{V}$, $I_C = 0$			-0.1	μA
DC current gain	$h_{FE(1)}$	$V_{CE} = -1\text{V}$, $I_C = -100\text{mA}$	100		320	
	$h_{FE(2)}$	$V_{CE} = -1\text{V}$, $I_C = -700\text{mA}$	35			
Collector-emitter saturation voltage	$V_{CE(sat)}$	$I_C = -500\text{mA}$, $I_B = -20\text{mA}$			-0.7	V
Emitter-base voltage	V_{BE}	$V_{CE} = -1\text{V}$, $I_C = -10\text{mA}$	-0.5		-0.8	V
Collector Output Capacitance	C_{ob}	$V_{CB} = -10\text{V}$, $I_E = 0$ $f = 1\text{MHz}$		19		pF
Transition frequency	f_T	$V_{CE} = -5\text{V}$, $I_C = -10\text{mA}$		120		MHz

CLASSIFICATION OF $h_{FE(1)}$

Rank	O	Y
Range	100-200	160-320

Typical Characteristics

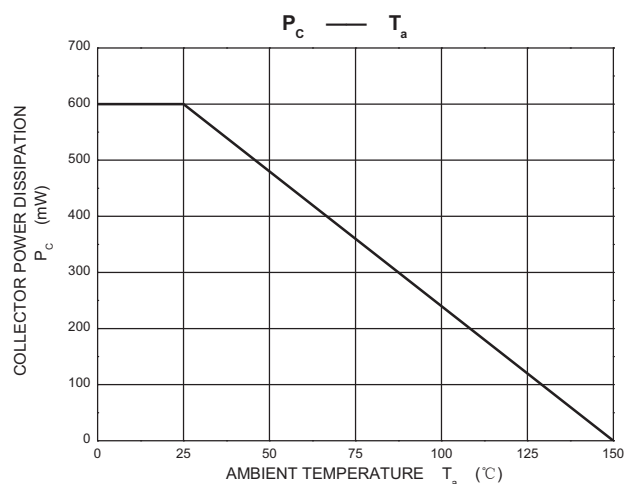
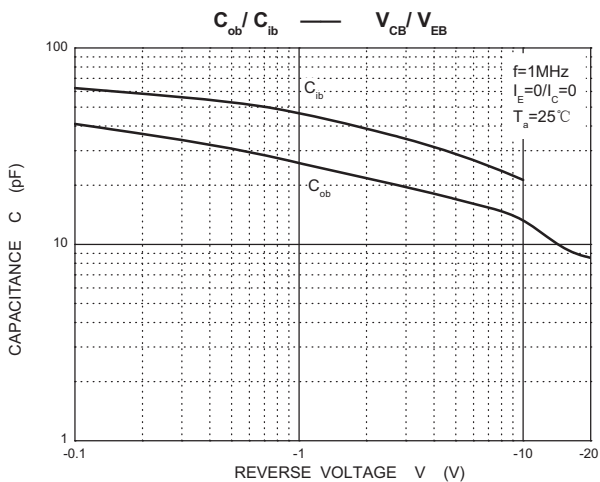
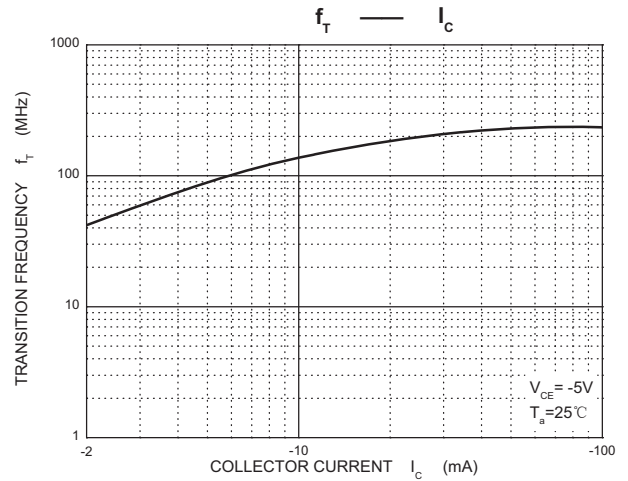
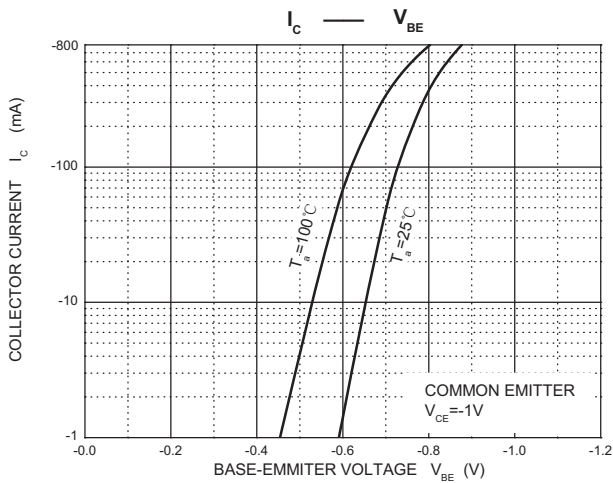
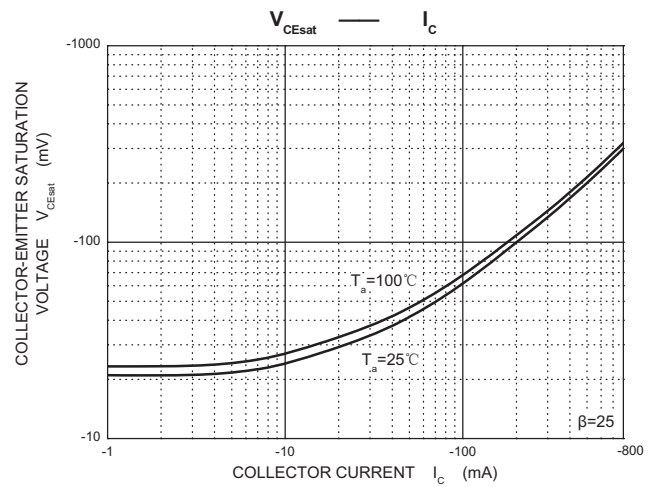
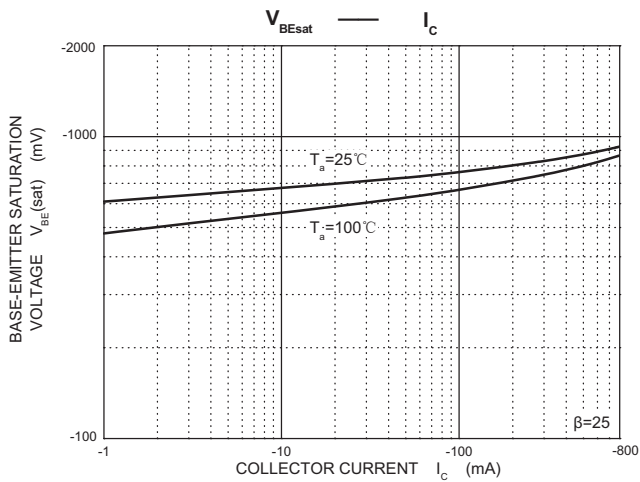
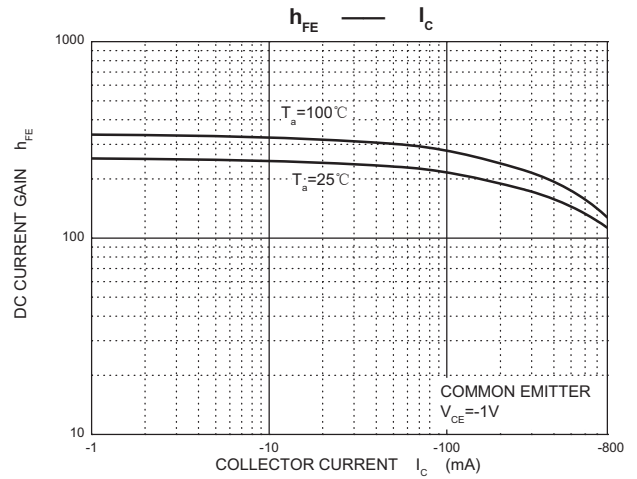
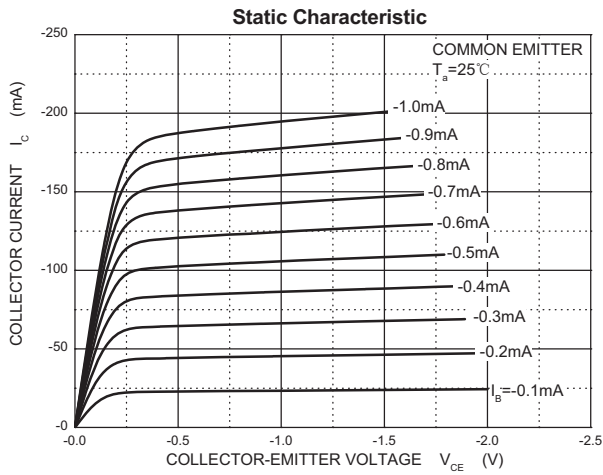

TO-92 Package Outline Dimensions

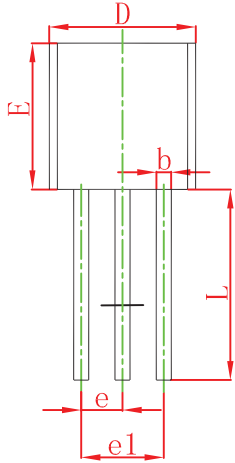
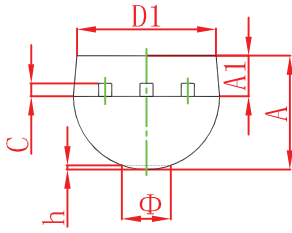

Symbol	Dimensions In Millimeters		Dimensions In Inches	
	Min	Max	Min	Max
A	3.300	3.700	0.130	0.146
A1	1.100	1.400	0.043	0.055
b	0.380	0.550	0.015	0.022
c	0.360	0.510	0.014	0.020
D	4.300	4.700	0.169	0.185
D1	3.430		0.135	
E	4.300	4.700	0.169	0.185
e	1.270 TYP		0.050 TYP	
e1	2.440	2.640	0.096	0.104
L	14.100	14.500	0.555	0.571
Φ		1.600		0.063
h	0.000	0.380	0.000	0.015

TO-92 Suggested Pad Layout

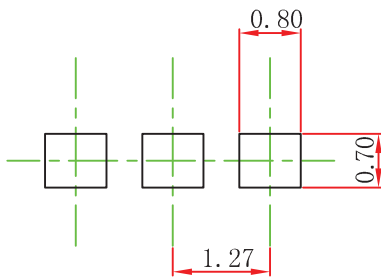

Note:

1. Controlling dimension: in millimeters.
2. General tolerance: $\pm 0.05\text{mm}$.
3. The pad layout is for reference purposes only.

NOTICE

JCET reserve the right to make modifications, enhancements, improvements, corrections or other changes without further notice to any product herein. JCET does not assume any liability arising out of the application or use of any product described herein.

TO-92 PACKAGE TAPEING DIMENSION

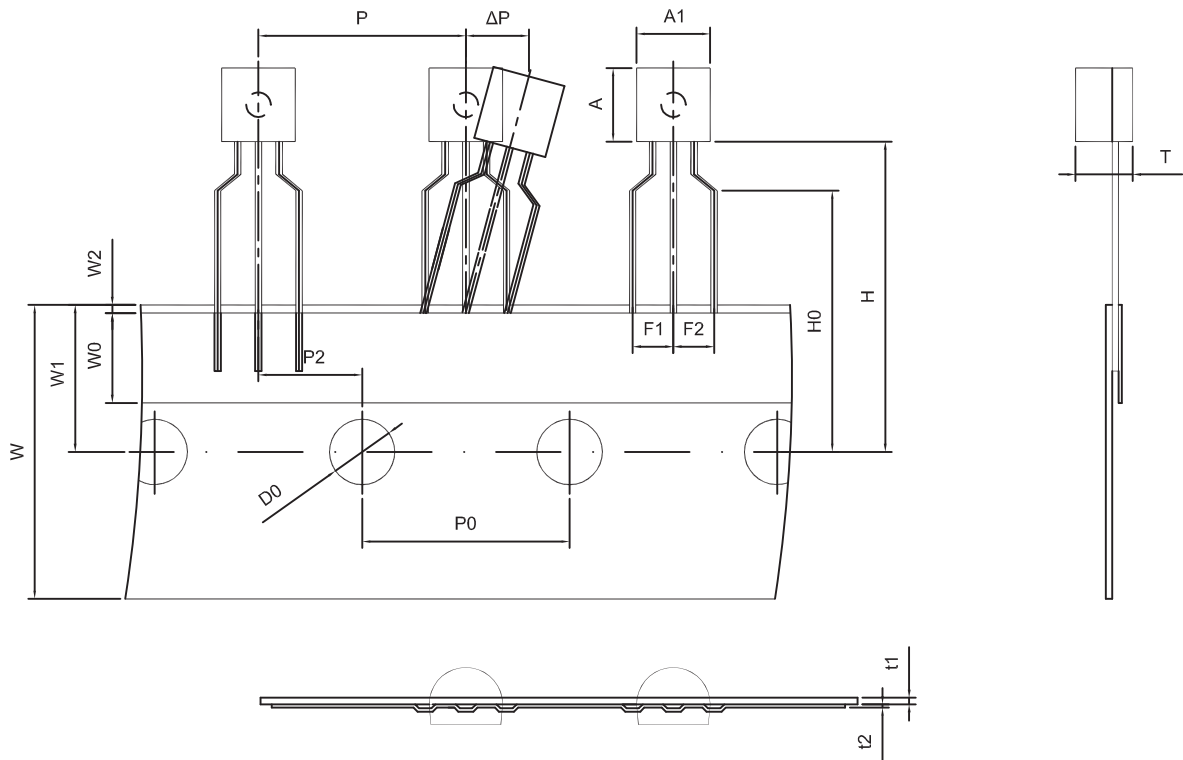

Dimiensions are in millimeter								
A1	A	T	P	P0	P2	F1	F2	W
4.5	4.5	3.5	12.7	12.7	6.35	2.5	2.5	18.0
W0	W1	W2	H	H0	D0	t1	t2	ΔP
6.0	9.0	1.0 MAX.	19.0	16.0	4.0	0.4	0.2	0

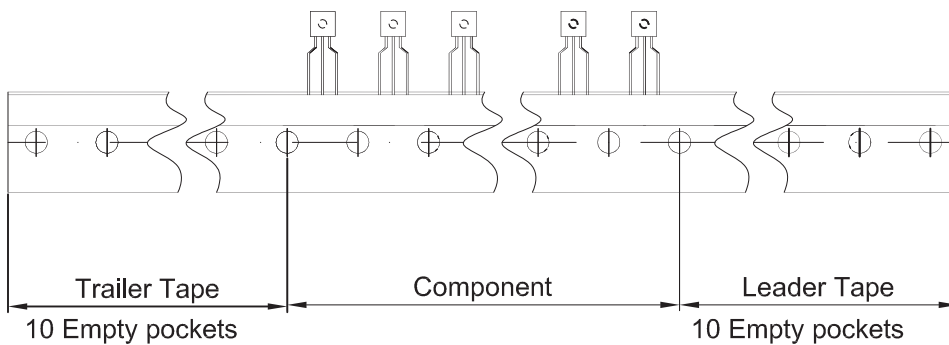

Package	Box	Box Size(mm)	Carton	Carton Size(mm)
TO-92	2000 pcs	333×162×43	20,000 pcs	350×340×250