

form	diameter	number	
a	0.300	8	メッキ有
b	0.500	30	メッキ有
c	0.900	13	メッキ有

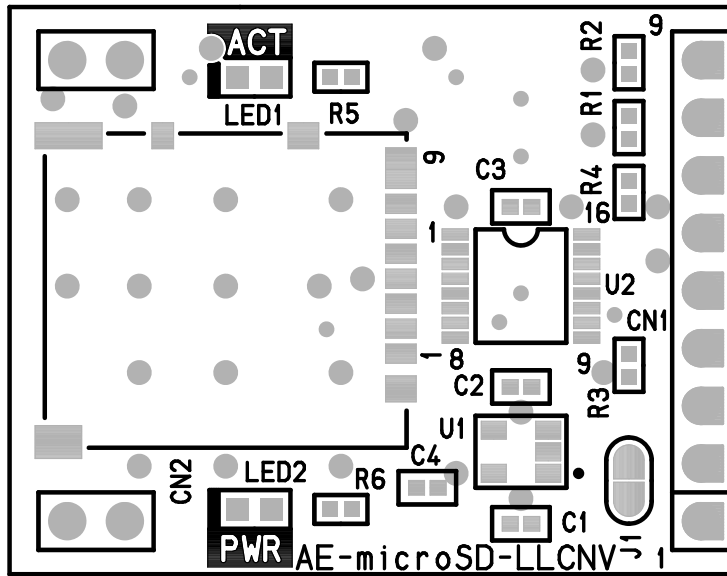

部品面シルク 部品面レジスト

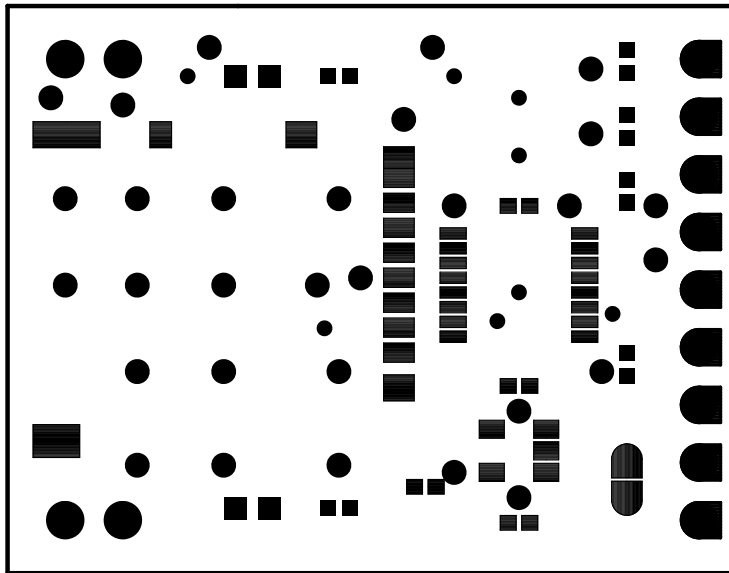

部品面レジスト

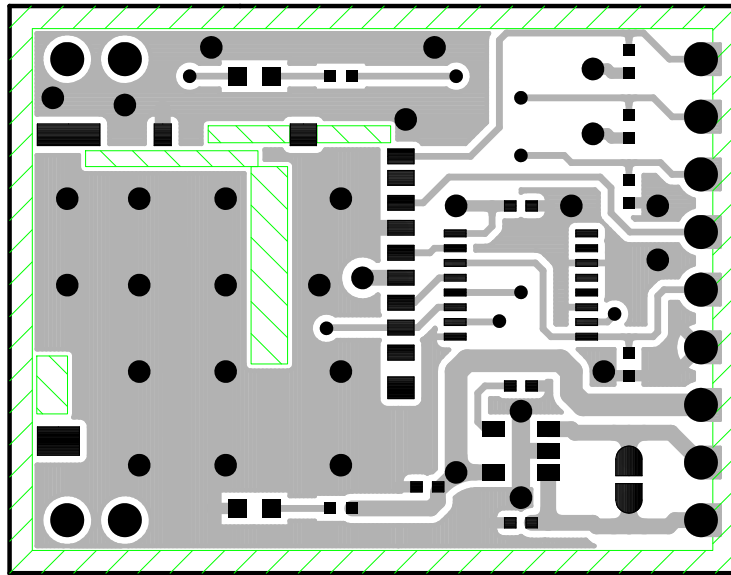

TOP (部品面パターン)

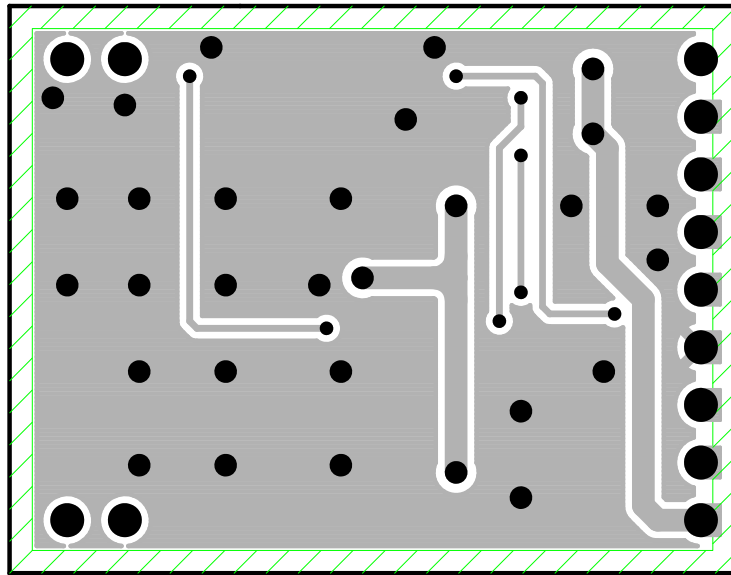

BOT (半田面パターン)

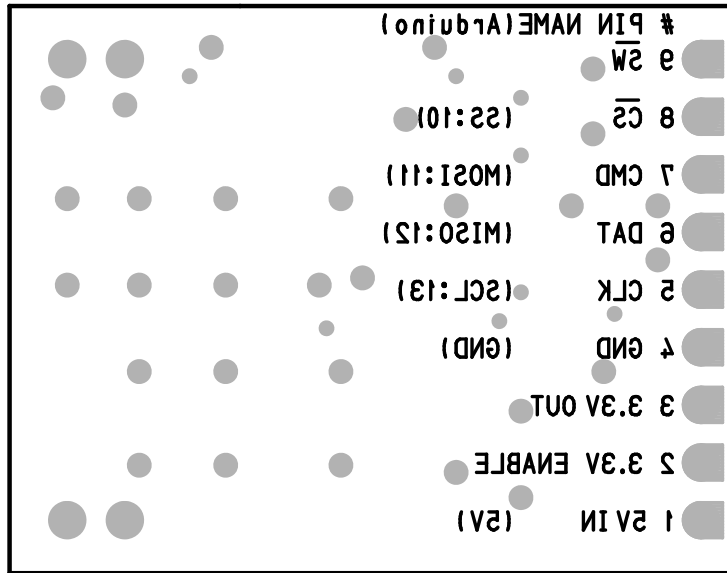

半田面シルク 半田面レジスト

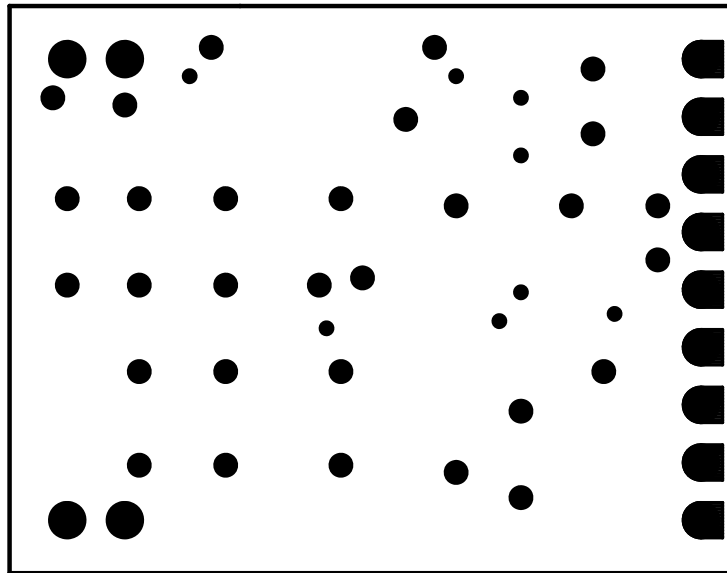

半田面レジスト

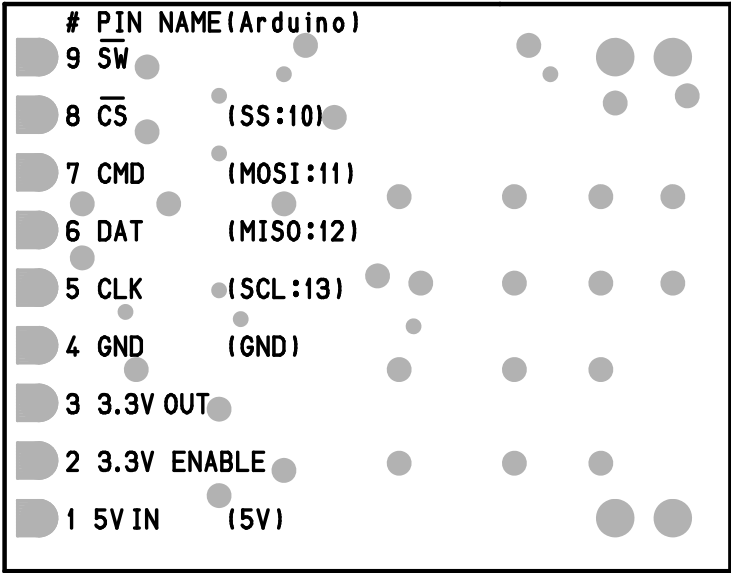

半田面にシス イ 半田面にシス

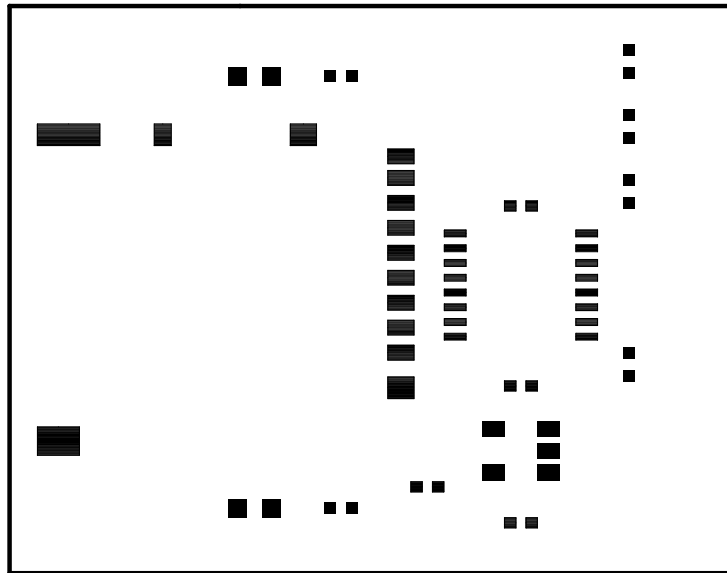

部品面メタル