



Serial No. : E190701 - 13

Electronical Specification

Date : 2019/7/1

	Parameters	SYM.	Electrical Spec.				Notes
			Min.	Typical	Max.	Unit	
1	Mercury Part No.		-				HUSG - 25.000 - 20
2	Nominal Frequency	FL	25.000000				MHz
3	Holder Type		-				HUS series (10.7 * 4.3 * 3.5mm)
4	Crystal Cut		-				AT-Cut
5	Mode of Oscillation		-				Fundamental Mode
6	Frequency Tolerance	F_tol	-30	~	30	ppm	at 25°C ± 3°C
7	Frequency Stability	F_tem	-30	~	30	ppm	Over Operating Temperature
8	Spurious Attenuation	SpdB			-4	dB	
9	Equivalent Series Resistance	Rr			40	Ω	
10	Shunt Capacitance	CO			7.0	pF	
11	Load Capacitance	CL		20		pF	
12	Drive Level	DL		100	500	uW	
13	MaxR/MinR	DLD2			10	Ω	0.1 uw ~ 100 uW , 5 points
14	MaxFR-MinFR	FDL2			10	ppm	0.1 uw ~ 100 uW , 5 points
15	MaxR	RLD2			40	Ω	0.1 uw ~ 100 uW , 10 points
16	Operating Temperature	T_use	-10	~	60	°C	
17	Storage Temperature	T_stg	-50	~	105	°C	
18	Aging	F_aging	-3		3	ppm	first year
19	Lead Free Approved Report	SGS Taiwan Ltd. Report No. : CE / 2019 / 22245					

Package Dimension (Unit : mm)

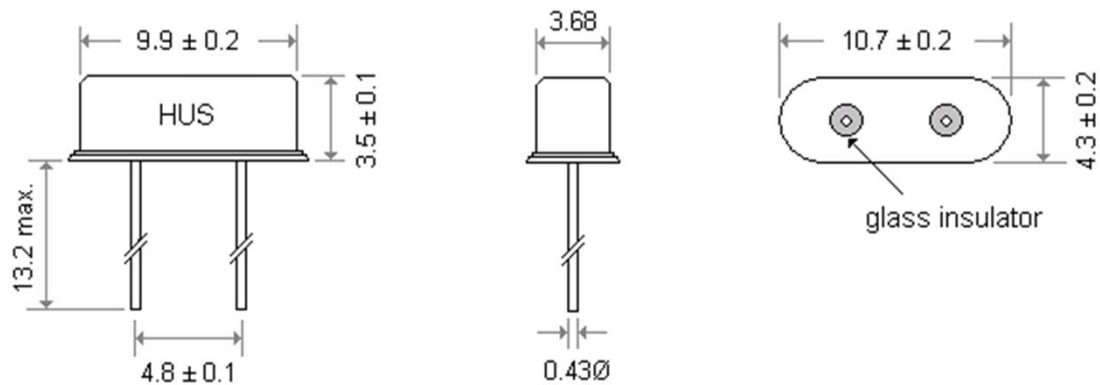

Marking

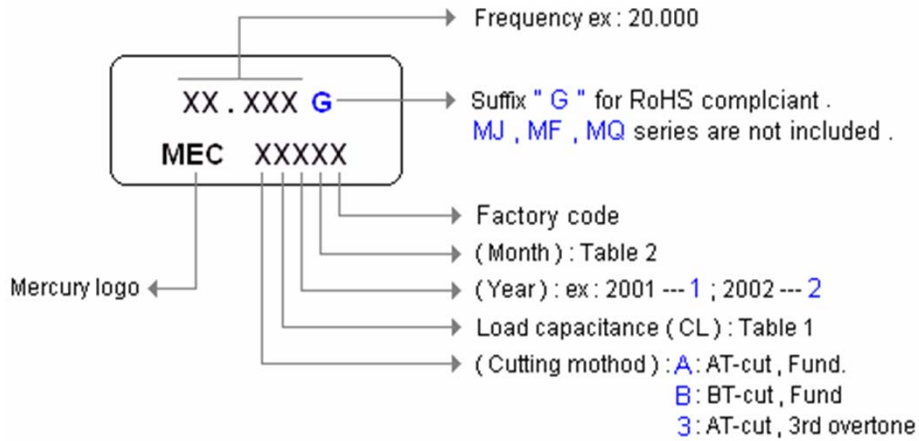
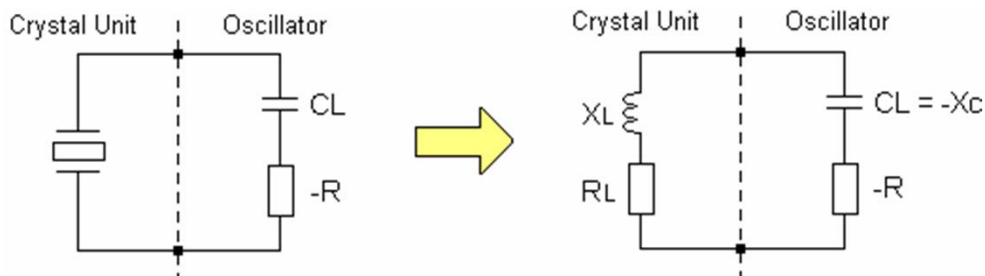
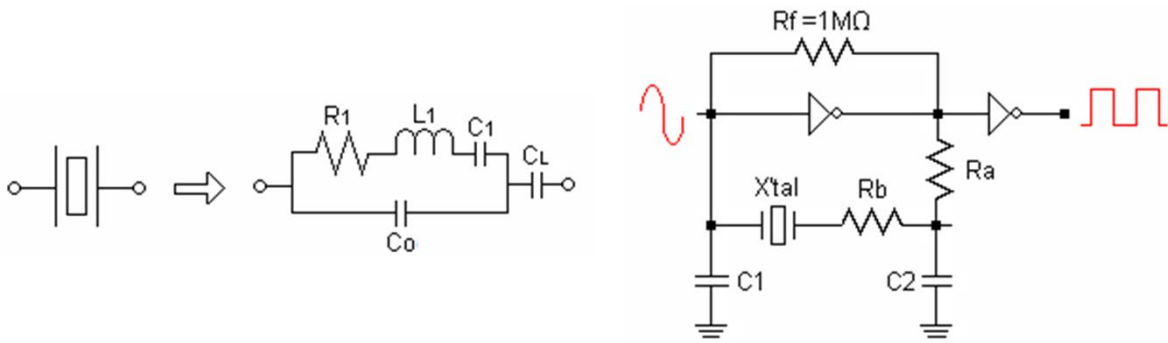

Table 1

CL	<10	10	11	12	13	14	15	16	17	18	19	20
Code	A	B	C	D	E	F	G	H	I	J	K	L
	21	22	23	24	25	26	27	28	29	30	31	32
	M	N	O	P	Q	R	S	T	U	V	W	X
	33	34	>34	Series								
	Y	Z	a	b								

Table 2

Month	Jan.	Feb.	Mar.	Apr.	May	Jun.	Jul.	Aug.	Sep.	Oct.	Nov.	Dec.
Code	A	B	C	D	E	F	G	H	I	J	K	L



The condition of starting oscillate :

$$RL \leq |-R| \quad \text{Mosc} = |-R| / R \geq 5$$

The balance condition after oscillation :

$$RL \leq |-R|$$

The balance condition of exact frequency :

$$XL = Xc ; \quad XL - Xc = 0$$

CL : Load capacitance

-R : Negative resistance

XL : Reactance of a quartz crystal unit

-Xc : Reactance of an oscillator unit

XL : Load resonance resistance



Environmental Specification

1. Temperature Test

*Temperature Cycling Test

Conditions:	Steps of cycle	(1)At-55 ° C , 30minutes	(3)At+85 ° C , 30minutes
		(2)At+25 ° C , 10~15minutes	(4)At+25 ° C , 10~15minutes
	Number of	3 times	

Results: Performance form of tested products must remain within specifications.

*Thermal Shock Test

Conditions:	Temperature T(H)+125 ° C , T(L)-55 ° C	Duration of cycle 3 times
	Exposure time at temperature extremes 5minutes	

Results: Performance form of tested products must remain within specifications.

*Low Temperature Test

Conditions:	Exposure time at temperature extremes 5minutes	Duration of test 96hours
Results:	There Should be no stain on surface of products	
	Frequency and wave form of tested products must remain within specifications.	

2. Aging Test

Conditions:	Temperature +85 ° C±2 ° C	Duration of test 96 hours
Results:	Deviation of frequency must be less than±3ppm	(+/-0.0003%)

3. Salt Spray Test

Conditions	Temperature 35 ° C±2 ° C	Duration of test 48 hours
	NaCl 5%	

4. Humidity Test

Conditions:	Temperature: +40 ° C+/-2 ° C	Relative humidity: 90~95%	Duration of test: 96 hours
Results:	Insulation resistance must be 500Mohm/100 minimum Vdc.		
	Resistance and wave form must remain within specification		

5. Fine Leak Test

Conditions:	Helium
Results:	Less than 2×10 ⁻⁸ Atm cc/sec



Mechanical Specification Sheet

1. Lead Solderability Test		
Conditions:	Dipping in solder(230 °C+/-5 °C) for 5 seconds	
Results:	More than 95% of surface being tested should be coated uniformly with solder.	
2. Vibration Test		
Conditions:	Frequency	10-55 Hz
	Amplitude	0.762 mm
	Sweep	1.0 minute
	Duration	2 hours
Results:	Performance form of tested products must remain within specifications.	
3. Drop Test		
Conditions:	Method of drop	Free drop
	Dropping floor	Hard wood board
	Height	75 cm
	Number of drops	3 times
Results:	Frequency and wave form of tested products must remain within specifications.	
4. Terminal Strength		
*lead Pulling Test		
Conditions:	Load	907.2gram
	Direction	To the downward
	Duration of	5 seconds
Results:	There should be no distortion in appearance	
*Lead Bending Test		
Conditions:	Load	453.6 gram
	Direction	90 °C to normal position
	Duration of	3 seconds in each cycle
Results:	There should be no distortion in appearance	

Notice :

- 1 Upon approval , please return a copy of this document with your signature to Mercury .
- 2 . Any change to these specifications have to be agreed by both parties and new revision of the specification sheets will be issued .