



SUPERTECH ELECTRONIC CO., LTD.

No.1, Lane 55, Rixin St., East Dist., Chiayi City 60066, Taiwan

TEL: 886-5-2782796 (REP) FAX: 886-5-2786786 (REP)

Website: www.supertech.com.tw

Email:supertec@ms5.hinet.net supertech@supertech.com.tw



SPECIFICATION

P/N: JH16K6B202L20KC-H13

Electical Characteristics 電氣特性

總阻值(R) Total resistance	B2K
總阻值容許誤差 Total resistance tolerance	±20% (More than 1MΩ±30%)
阻值線性 Resistance taper	B
摺動雜音 Sliding noise	Less than 47mV
殘留阻值 Residual resistance	≤ 20Ω (R > 10K) ≤ 10Ω (R ≤ 10K)
定格電力 Rated power	Linear(B)taper:0.125W Other taper:0.06W
額定電壓 Rated voltage(V)	E=√P.R E= Rated voltage 額定電壓(V) P= Power rating 額定電力(W) R= Nominal total resistance 公稱全阻抗值(Ω) 當額定電壓超過最高使用電壓的時候，最高使用電壓即為額定 When the rated voltage exceeds the maximum operating voltage, the maximum operating voltage shall be the rated voltage.
最高使用電壓 Max. operating voltage	Linear(B)taper:200V Other taper:150V
絕緣阻抗Insulation resistance	More than 100 MΩ at DC 500V
耐電壓Withstand voltage	1 minute at AC 500V

Mechanical Characteristics 機械特性

全回轉角度 Total rotational angle	300°±5°
全回轉扭力 Rotational torque	30~200 gf.cm
軸推拉強度 Shaft push-pull strength	7Kgf max
全回轉止強度 Rotational stopper strength	6Kgf max
迴轉壽命 Rotational life	15000 cycles

General 一般事項

使用溫度範圍 Operating temperature	-10°C ~ +70°C
手工焊接 Manual soldering	300°C max 3 sec

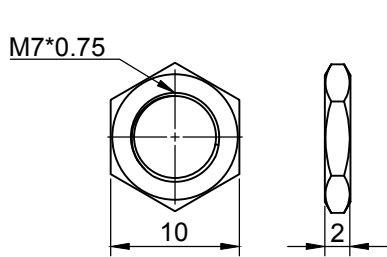
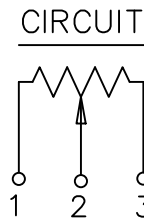
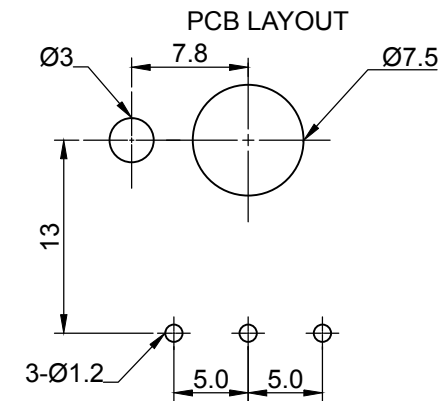
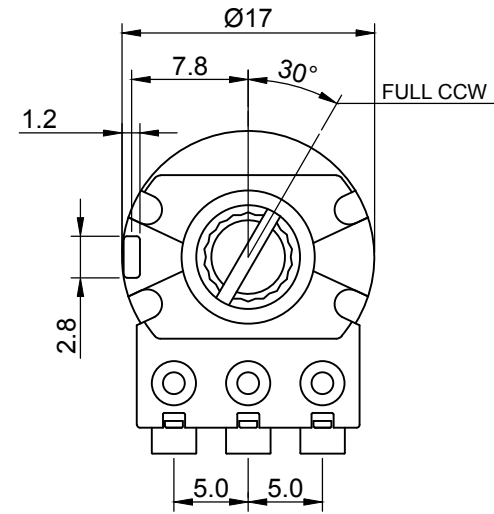
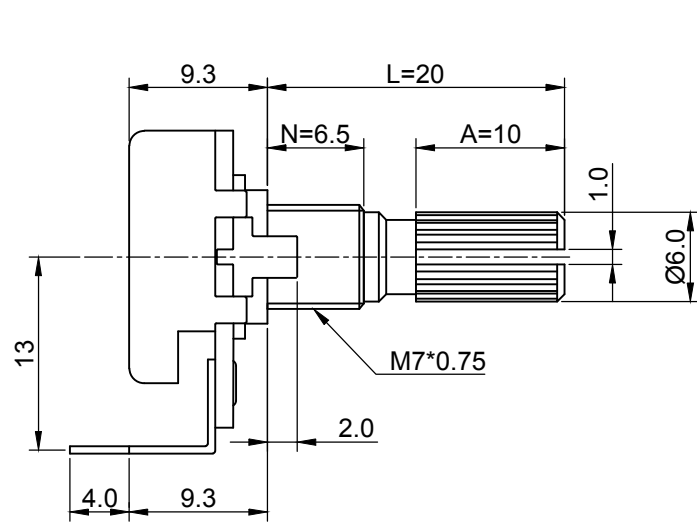

NUT

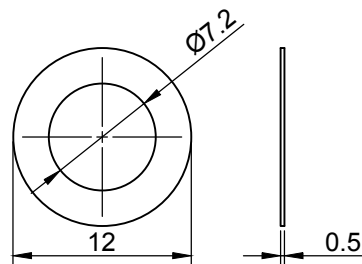

WASHER

N = 6.5mm			
Shaft Type	L	15	20
KC/CI	A	6	10

未標註公差	
10 以下	± 0.3
10 ~ 100	± 0.5
100 以上	± 0.8

Supertech Electronic Co., Ltd.

規格型號： 16K6-BXXX L20KC H13

核准：



審核：



製圖：

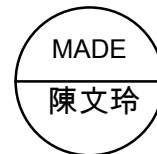

單位

mm

編號

(客戶認可簽章)

比例

2 : 1

製圖日期

版本

1.0

