

CUSTOMER'S NAME

AKIZUKI DENSHI TSUSHO CO., LTD.

ALPHA REFERENCE NO.

TSM21040003

SPECIFICATION

PART NO.	ALPHA MODEL NAME
1.	MF01A-N-221-A11

MODEL NAME
MODEL NO.

APPROVAL

PREPARED BY	REVIEWED BY	APPROVED BY
 徐 2021.04.12 鳳妮	 林 2021.04.12 素吟	 蔡 2021.04.12 信村



台灣艾華電子工業股份有限公司

33045 桃園市桃園區中正路 1221 號 9 樓

TAIWAN ALPHA ELECTRONIC CO., LTD.

9F, No. 1221, Chung Cheng Rd., Taoyuan Dist., Taoyuan City, 330 Taiwan





Tel: 886-3-3577799 Fax: 886-3-3577700

EMAIL: sales@taiwanalpha.com.tw

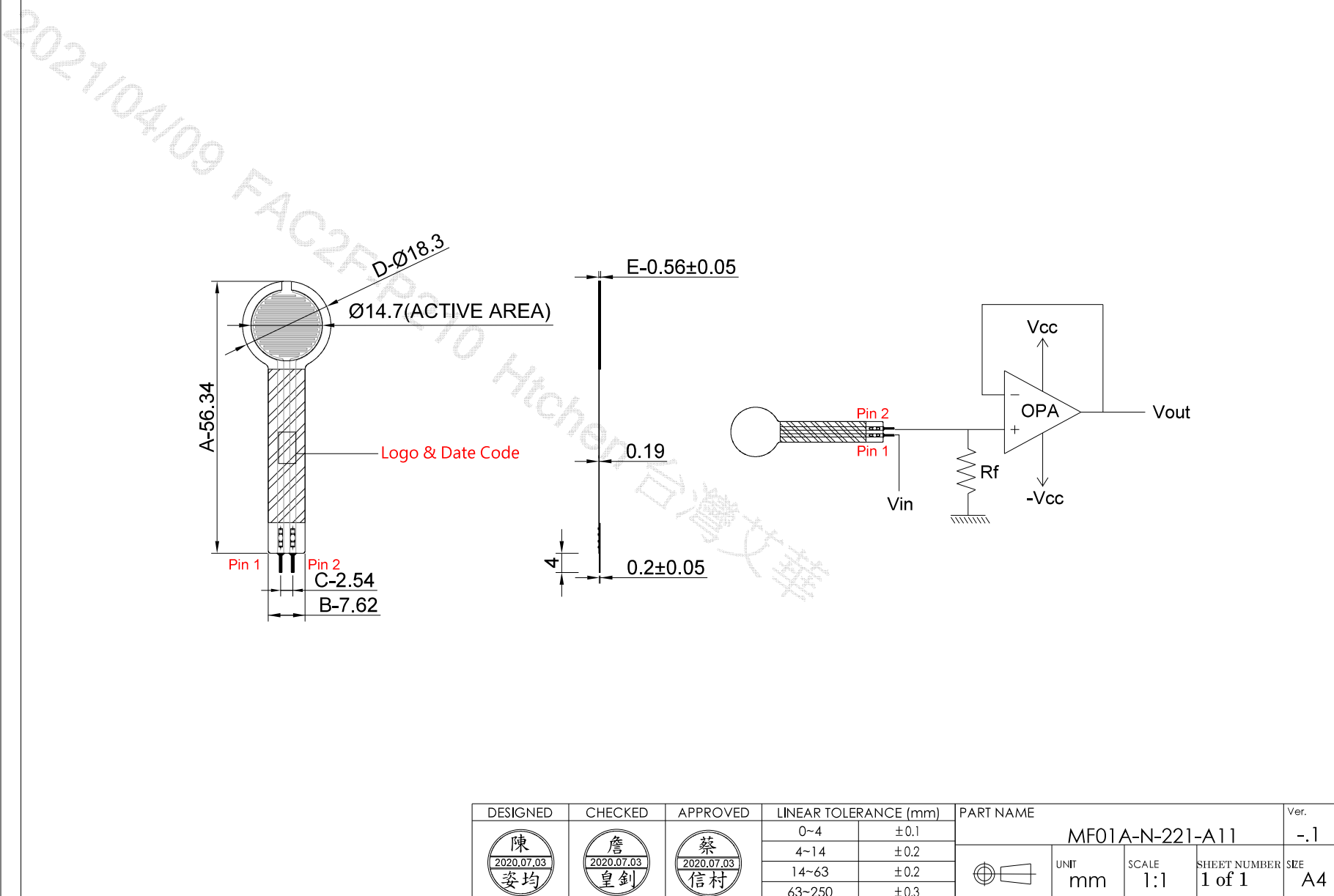
URL: <http://www.taiwanalpha.com>

1 2 3 4 5 6



DESIGNED	CHECKED	APPROVED	LINEAR TOLERANCE (mm)		PART NAME			Ver.
 陳 姿均 2020.07.03	 詹 皇劍 2020.07.03	 蔡 信村 2020.07.03	0~4	±0.1	MF01A-N-221-A11			-.1
			4~14	±0.2				
			14~63	±0.2	 UNIT mm	SCALE 1:1	SHEET NUMBER 1 of 1	SIZE A4
			63~250	±0.3				



規格書

SPECIFICATION

Model name:MF01A-N-221-A11

檢驗項目 Inspection Item	規格 SPEC.	備註 Notes
起始按壓力 Actuation Force	300g	
按壓力靈敏度範圍 Force Sensitivity Range	300~15000g(3N~150N)	
解析度 Force Resolution	Continuous(Analog)	
有效區域 Active Area	φ 14.7 mm	
未按壓阻值 Stand-Off Resistance(Unloaded)	>20MΩ	
重覆性 Force Repeatability (Single Part)	2%	100 actuations of 10kg, one standard deviation/mean
重覆性 Force Repeatability (Part To Part)	10%	100 sensors same batch, one standard deviation/mean
反應時間 Response Time	<1ms	
操作溫度 Operation Temp.	-30°C to +85°C	
使用壽命 Life Cycle	5 million	1kg force at 3Hz Without Failure
高溫儲存測試 High Temperature Storage	+85°C *120hrs	
低溫儲存測試 Low Temperature Storage	-30°C *120hrs	
高濕儲存測試 High Humidity Storage	+70°C , 85%RH*96hrs	

Date : 2020/12/18 Ver. : A

本資料為台灣艾華電子工業股份有限公司之機密與專有財產，非經書面許可，不得對外透露或使用本文件，亦不得複印、複製或轉變成任何其他形式使用。

The Information is confidential property of Taiwan Alpha Electronic Co., LTD. Unauthorized distribution, reproduced or disclosed part without prior written permission of Taiwan Alpha Electronic Co., LTD. is strictly prohibited.

Membrane sensor usage tips

MF/MK/MAT/MAS/MVT/MVS/MMS/MMT series

Please follow the below stipulate to avoid error conditions such as false triggering, false readings, pre-loading, or gouging and cracking of the sensor.

1. The side of adhesive should be used on the firm, flat and smooth surfaces, can't not be used on the curved surfaces. Also, be careful of trapped air bubbles or dirt particles when laminating the membrane sensor to surface, it cause the sensor to appear loaded in the absence of an external load. Recommended to clean the surface before adhesive.
2. The pre-pressing method is as follows: before the test, each sensor was conditioned 5 times dynamically for about 1 sec by compressing to a pressure to bring the sensor from a relaxed state to an active state.
3. Do not store the sample in a humid environment. Please used on the substrate within 12 months after shipment.
4. Do not kink, bending or scratches the tail of membrane sensors. The traces should not be bent more than 90° as the silver conductive leads could break. Also, be careful if bending the tail near the active area 5mm. This can cause stress on the active area and may result in pre-loading and false readings.
5. Do not block the vent. This vent assures pressure equilibrium with the environment, as well as allowing even loading and unloading of the device. Blocking this vent could cause short circuit.
6. Please use an overlay, such as a polycarbonate film or an elastomer, to prevent gouging of the membrane sensors from sharp objects.
7. Do be careful of kinks or dents in active areas. They can cause false triggering of the sensors.
8. Do not apply excessive shear force. This can cause delamination of the layers.
9. Do not exceed 1mA of current per square centimeter of applied force (actuator area). This can irreversibly damage the device.
10. With flexible substrates, the solder joint will not hold and the substrate can easily melt and distort if solder directly to the exposed silver traces. Choose appropriate connection as table 1, such as FFC connector, solder tabs, female contacts, or female contact with housing connectors.
11. If the Solder pin needs to be soldered, the contact between the torch and the Solder pin should be within 2 sec and the soldering can't be repeated. To prevent meltdown of pin to plastic affect the connection. It is recommended to use flux during soldering that can help lead-free solder flow more easily.





Date : 2020/03/05 Ver. : C

本資料為台灣艾華電子工業股份有限公司之機密與專有財產，非經書面許可，不得對外透露或使用本文件，亦不得複印、複製或轉變成任何其他形式使用。

The Information is confidential property of Taiwan Alpha Electronic Co., LTD. Unauthorized distribution, reproduced or disclosed part without prior written permission of Taiwan Alpha Electronic Co., LTD. is strictly prohibited.

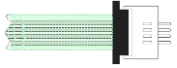

Table 1

Pitch	FFC Connector	Solder Tabs(pin)	Female contacts	Female contact with housing
2.54mm (For example: 2 pins type)				
1.00mm (For example: 4 pins type)		N/A	N/A	N/A

Date : 2020/03/05 Ver. : C

本資料為台灣艾華電子工業股份有限公司之機密與專有財產，非經書面許可，不得對外透露或使用本文件，亦不得複印、複製或轉變成任何其他形式使用。

The Information is confidential property of Taiwan Alpha Electronic Co., LTD. Unauthorized distribution, reproduced or disclosed part without prior written permission of Taiwan Alpha Electronic Co., LTD. is strictly prohibited.