



Series No. : VC20220111T03

Date : 2022/1/11

Electrical Specification

	Parameters	SYM.	Electrical Spec.				Notes
			Min.	Typical	Max.	Unit	
1	Mercury Part No.		-				ML49G-9.216-30-30/30X
2	Nominal Frequency	FL	9.216000			MHz	
3	Holder Type		-				HC- 49/US (SMD ---12.4 * 4.5 * 3.0 mm)
4	Crystal Cut		-				AT-Cut
5	Mode of Oscillation		-				Fundamental Mode
6	Frequency Tolerance	F_use	-30		30	ppm	at 25°C ± 3°C
7	Frequency Stability	F_tem	-30		30	ppm	Refer at 25°C
8	Spurious Attenuation	SPDB			-4	dB	-2000ppm ~ +10000 ppm , 25 points
9	Equivalent Series Resistance	RR			60	Ω	
10	Shunt Capacitance	C0			5.0	pF	
11	Load Capacitance	CL		30		pF	
12	Drive Level	DL			100	uW	
13	MaxR	RLD2			60	Ω	0.1 uw ~ 100 uW , 10 points
14	MaxFR-MinFR	FDDL			10	ppm	0.1 uw ~ 100 uW , 10 points
15	Operating Temperature	T_opr	-10		60	°C	
16	Storage Temperature	T_stg	-50		105	°C	
17	Aging	F_aging	-3		3	ppm	First year
18	Lead Free Approved Report	SGS Taiwan Ltd. Report No. : ETR21504385					

Package Dimension (Unit : mm)

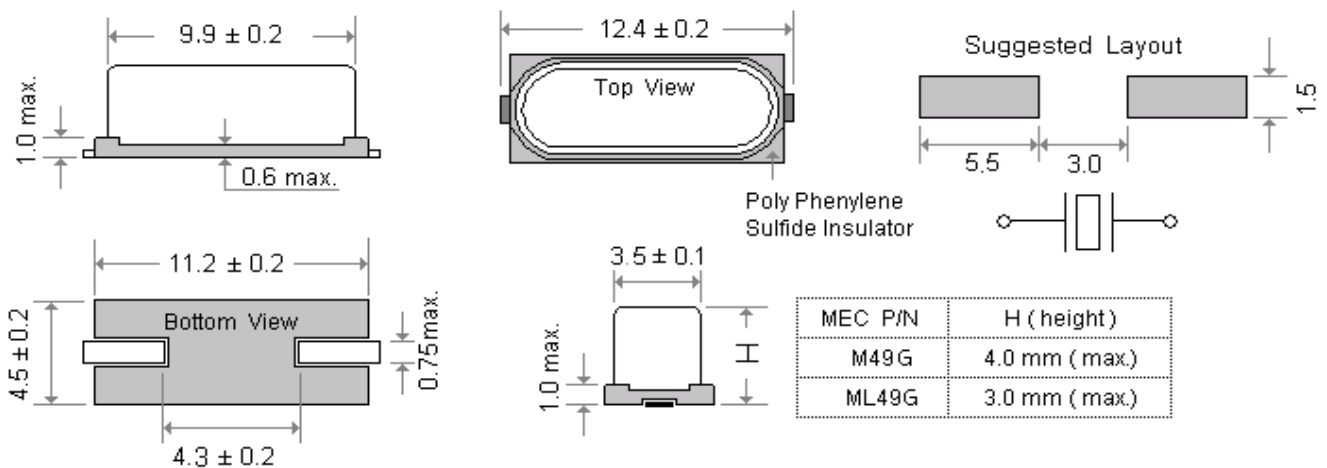

Marking

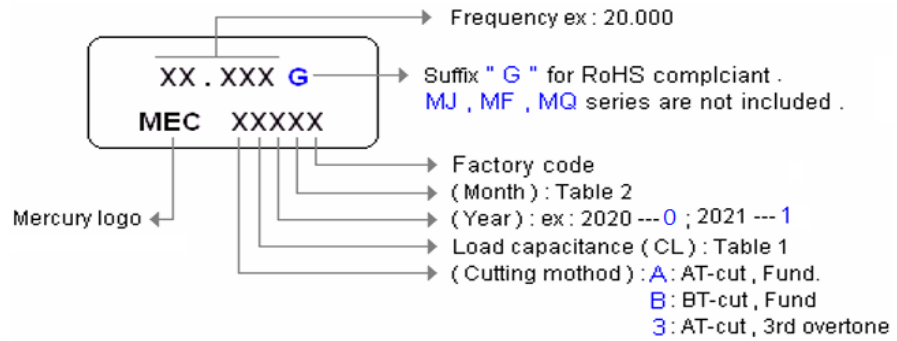

Table 1

CL	<10	10	11	12	13	14	15	16	17	18	19	20
Code	A	B	C	D	E	F	G	H	I	J	K	L
CL	21	22	23	24	25	26	27	28	29	30	31	32
Code	M	N	O	P	Q	R	S	T	U	V	W	X
CL	33	34	>34	Series								
Code	Y	Z	a	b								

Table 2

Month	Jan.	Feb.	Mar.	Apr.	May	Jun.	Jul.	Aug.	Sep.	Oct.	Nov.	Dec.
Code	A	B	C	D	E	F	G	H	I	J	K	L

Equivalent Circuit of crystal

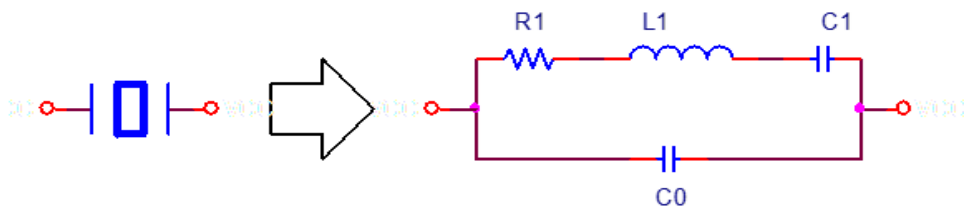

Oscillation circuit

