

■ **Features**

- 0.54 inch dual digit display
- Long lifetime operation
- IC compatible
- Low power dissipation
- Black surface & white segment or dot
- Number of Pins:18

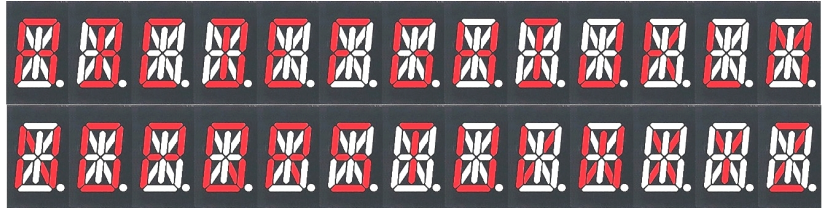

表示例

■ **Applications**







- Counting device
- Clock

■ **Absolute Maximum Rating** (Ta=25°C)

Item	Symbol	Value		Unit
		RA/R/YG/Y	B/G/W	
DC Forward Current	I _F	20	20	mA
Pulse Forward Current#	I _{FP}	100	100	mA
Reverse Voltage	V _R	5	5	V
Power Dissipation	P _t	44	66	mW
Operating Temperature	Topr	-30 ~ +70		°C
Storage Temperature	Tstg	-40~ +85		°C
Lead Soldering Temperature(1.6mm from seating plane)	Tsol	260°C/5sec		°C

#Pulse width Max.10ms Duty ratio max 1/10

■ **Electrical -Optical Characteristics** (Ta=25°C)

Part Number	Color		V _F (V)			I _R (μA)	I _v (mcd)			λD(nm)			
			Min.	Typ.	Max.	Max.	Min.	Typ.	Max.	Min.	Typ.	Max.	
			I _F =20mA			V _R =5V	I _F =20mA						
OSL20541-IW(LW)	White	W	-	3.3	3.6	20	150	200	-	X=0.27,Y=0.28			
OSL20541-IB(LB)	Blue	B		-	3.3	3.6	20	40	60	-	460	470	475
OSL20541-IG(LG)	Pure Green	G		-	3.3	3.6	20	150	200	-	515	525	530
OSL20541-IYG(LYG)	Yellow Green	YG		-	2.2	2.6	20	10	15	-	565	571	575
OSL20541-IY(LY)	Yellow	Y		-	2.1	2.5	20	40	60	-	585	590	595
OSL20541-IR(LR)	Red	R		-	2.1	2.5	20	10	20	-	625	630	640
OSL20541-IRA(LRA)	High Luminance Red	RA		-	2.1	2.5	20	60	100	-	620	625	630

*1 Tolerance of measurements of chromaticity coordinate is ±10%
 *2 Tolerance of measurements of dominant wavelength is ±1nm
 *3 Tolerance of measurements of luminous intensity is ±15%
 *4 Tolerance of measurements of forward voltage is±0.1V

■ Package Dimensions and Pin Function

**OSL20541-IX
(Common Anode type)**

Note:
1, Unit : mm (Tolerance: ±0.25mm unless otherwise noted)
2, The slope angle of any PIN may be ±5.0° Max

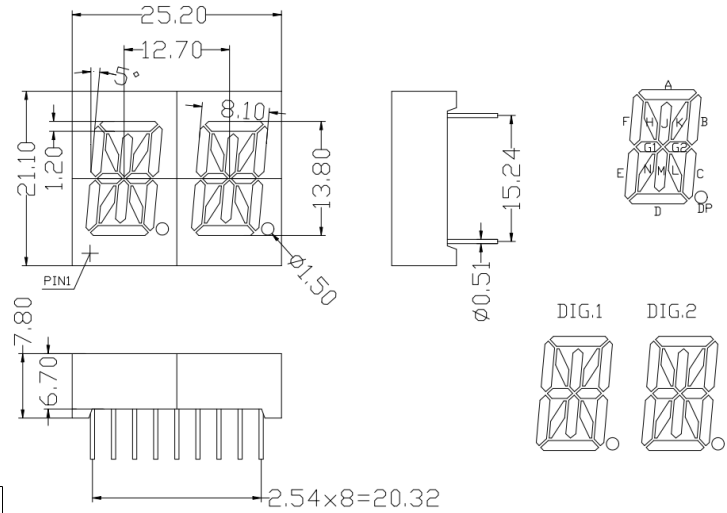
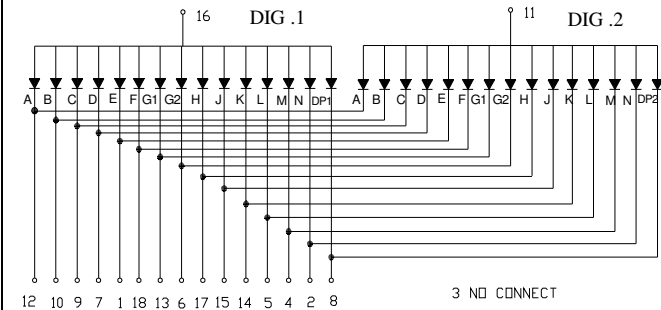

**OSL20541-LX
(Common Cathode type)**

Note:
1, Unit : mm (Tolerance: ±0.25mm unless otherwise noted)
2, The slope angle of any PIN may be ±5.0° Max

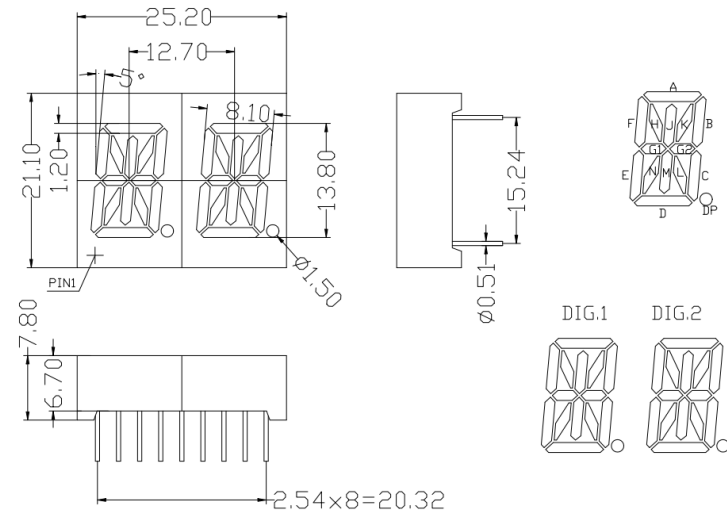
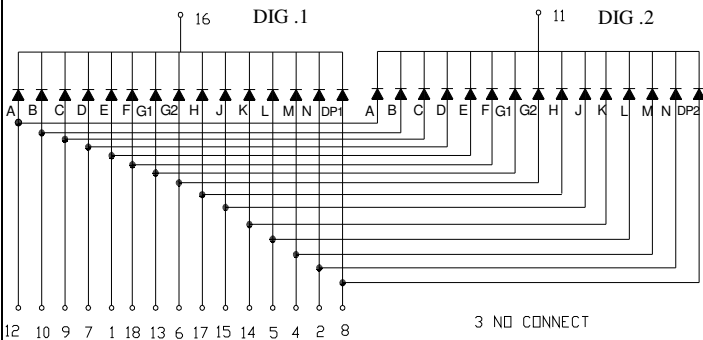

InGaN LED

TYPICAL ELECTRICAL/OPTICAL CHARACTERISTIC CURVES

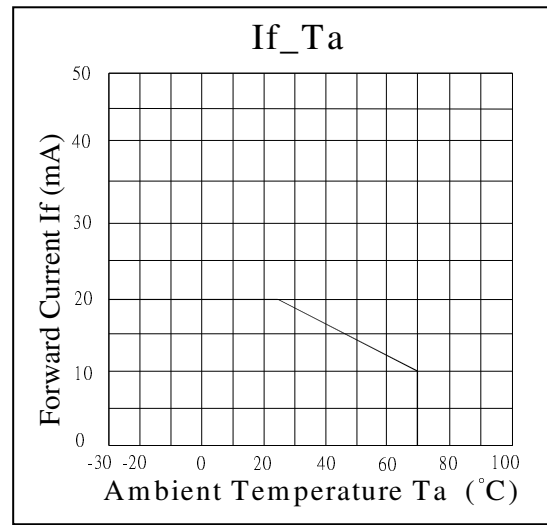
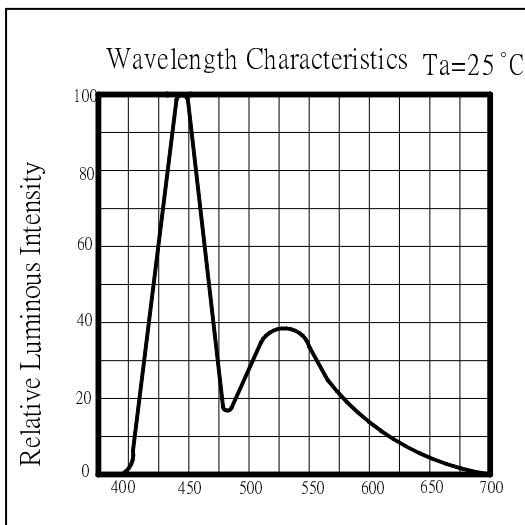
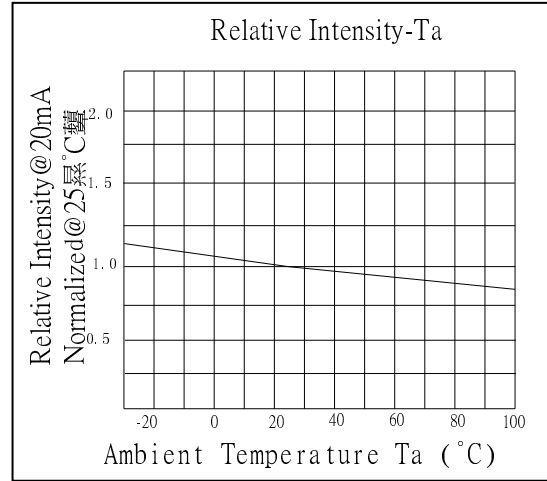
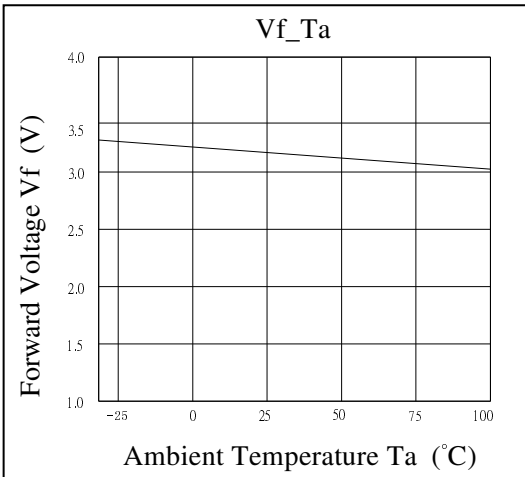
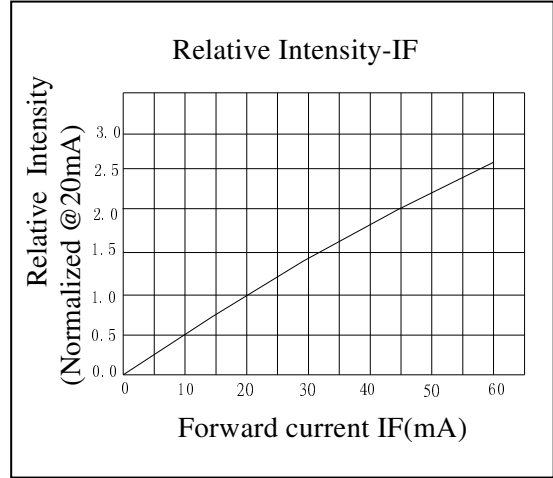
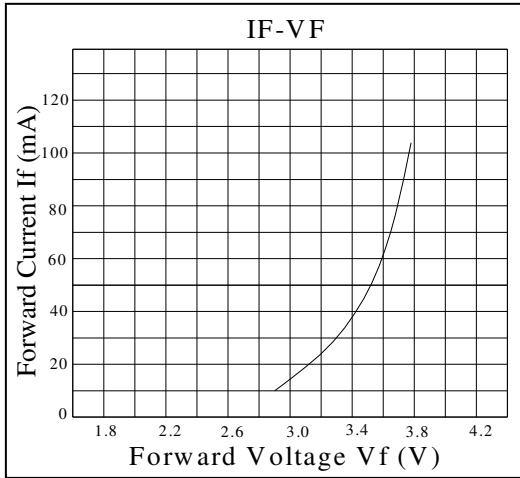

InGaN LED

TYPICAL ELECTRICAL/OPTICAL CHARACTERISTIC CURVES

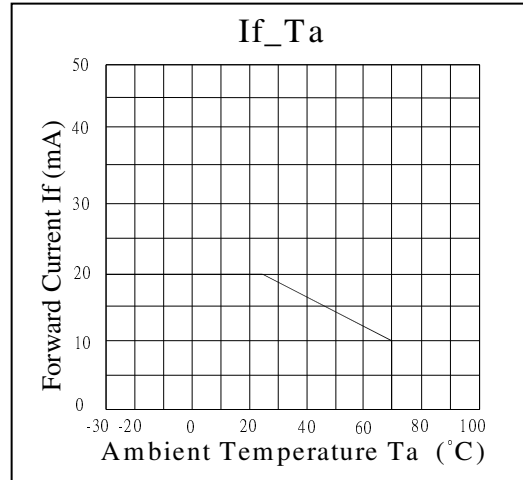
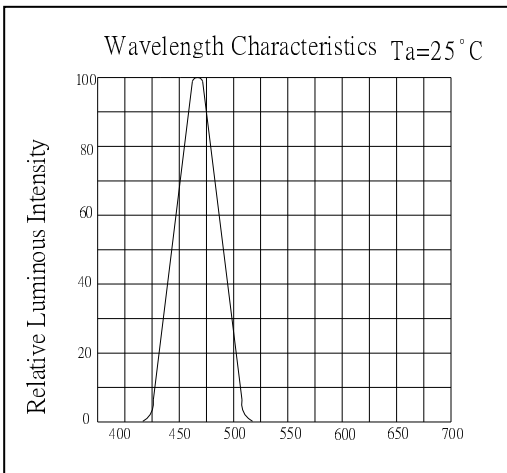
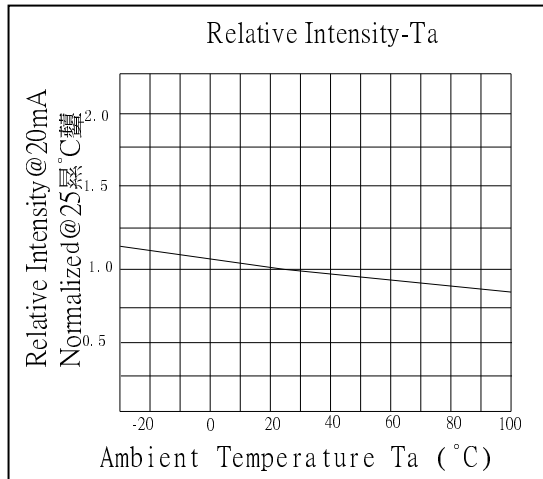
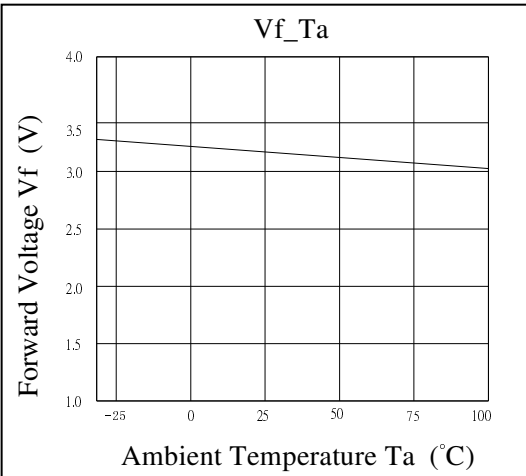
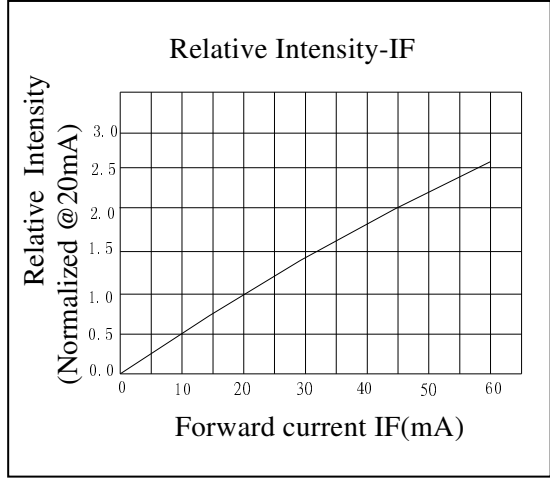
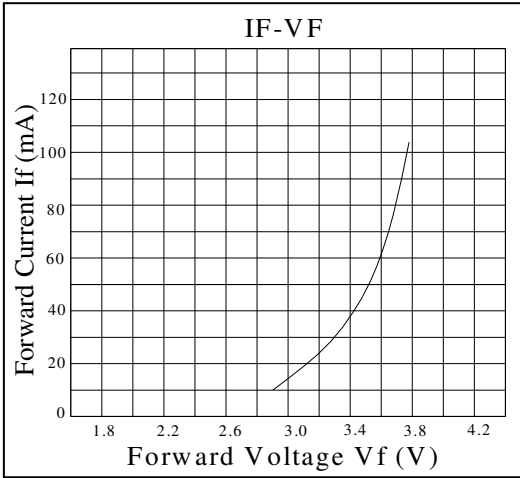

InGaN LED

TYPICAL ELECTRICAL/OPTICAL CHARACTERISTIC CURVES

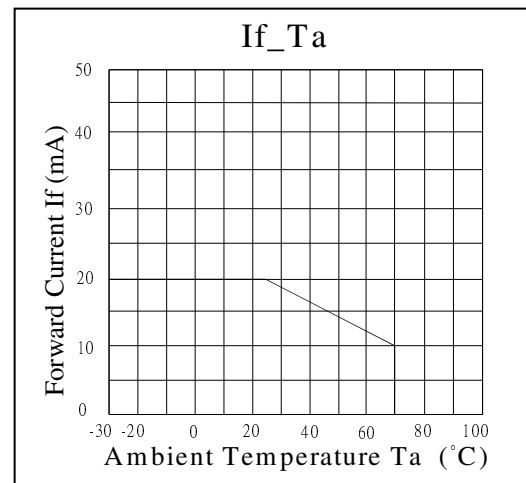
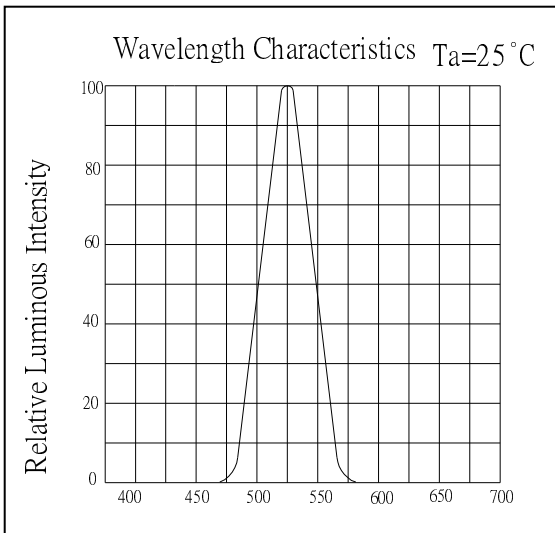
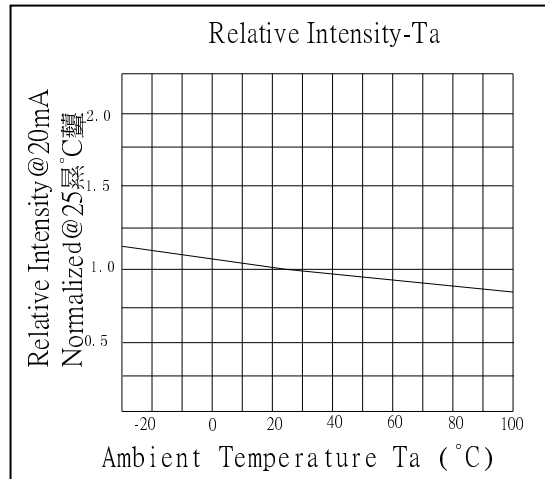
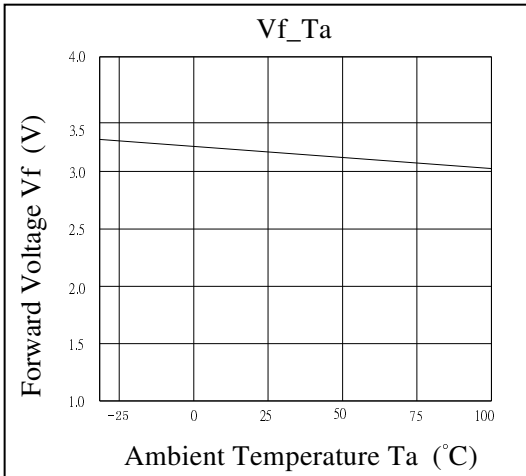
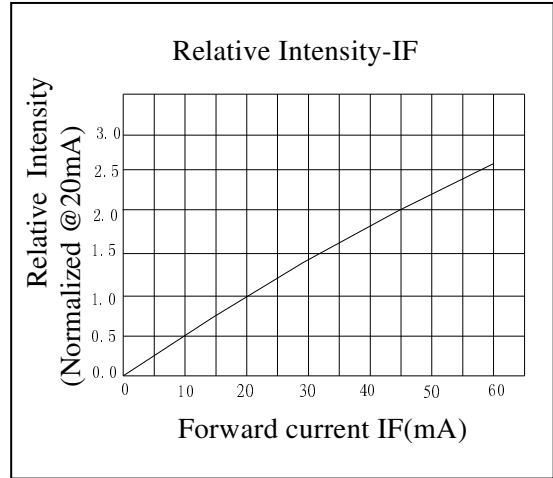
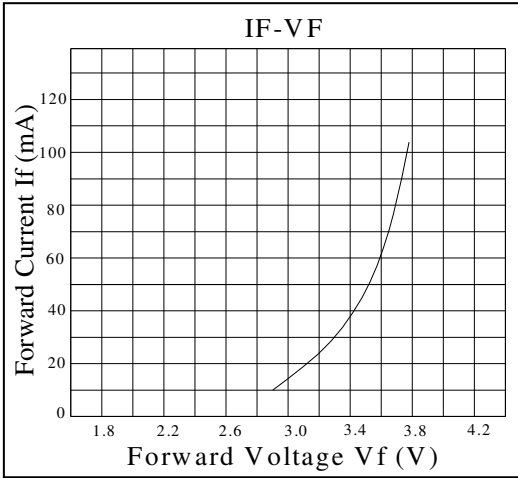

AlGaInP LED

TYPICAL ELECTRICAL/OPTICAL CHARACTERISTIC CURVES

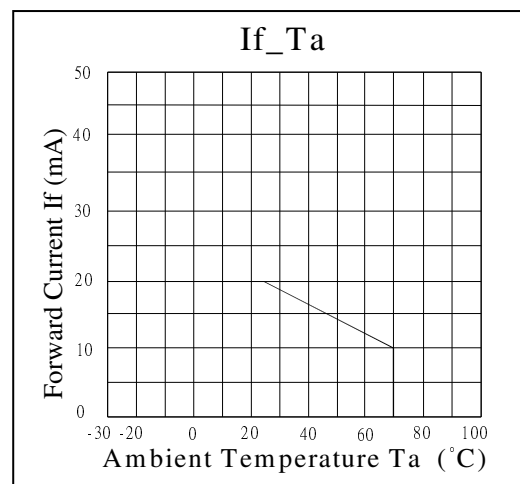
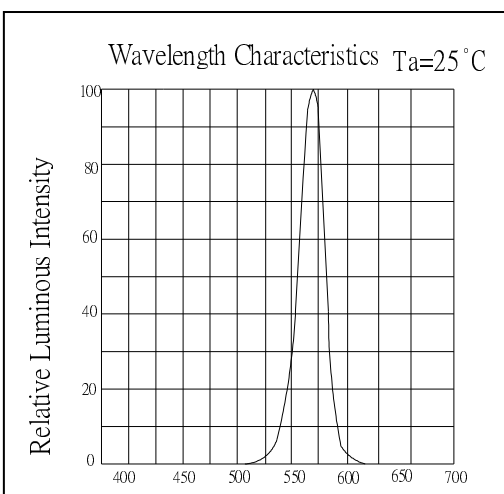
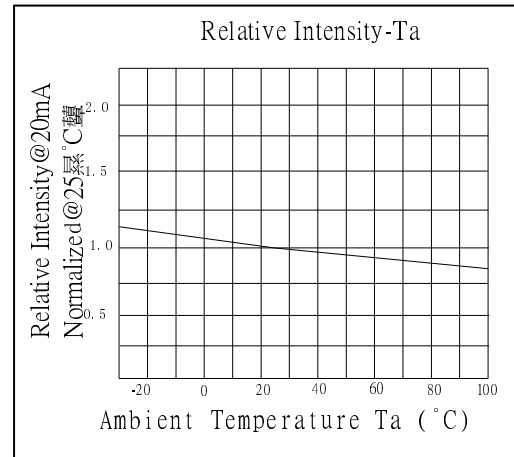
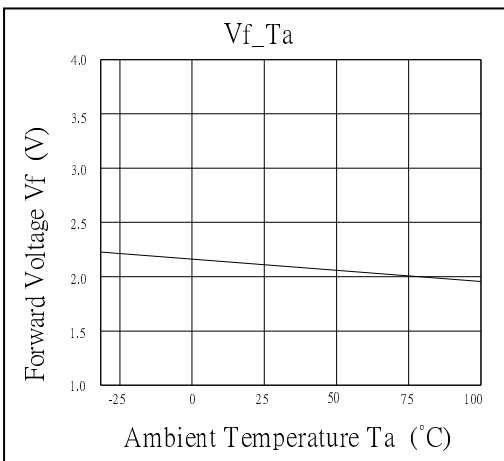
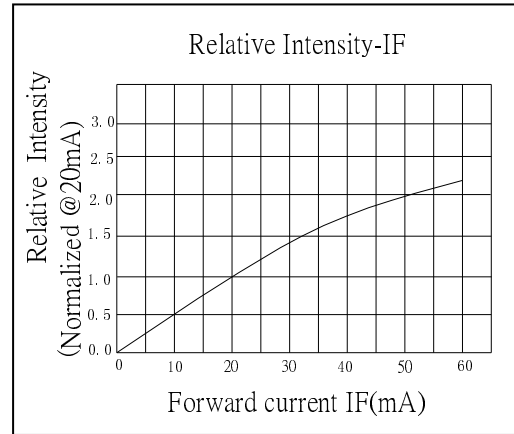
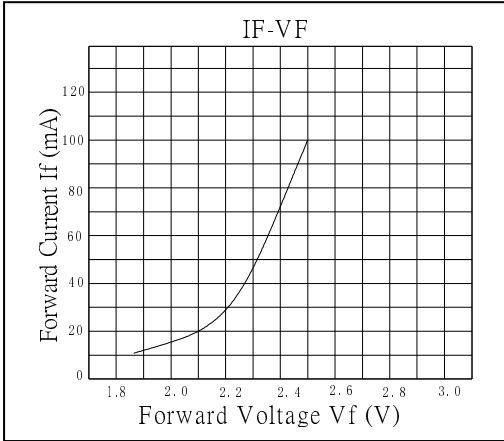

AlGaInP LED

TYPICAL ELECTRICAL/OPTICAL CHARACTERISTIC CURVES

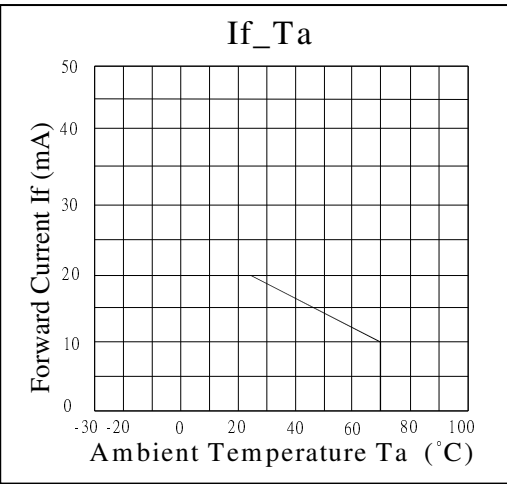
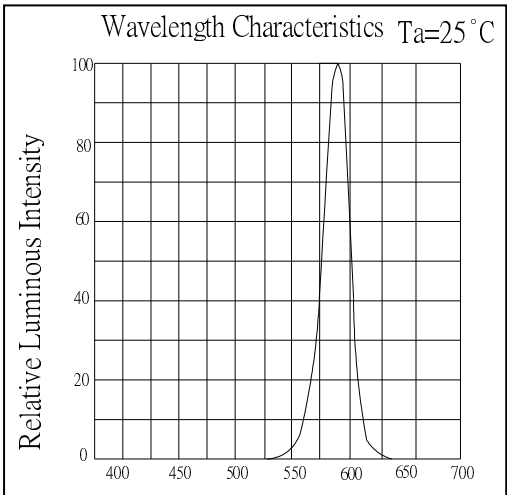
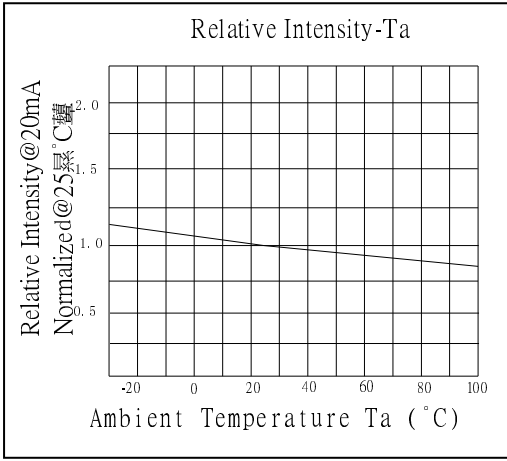
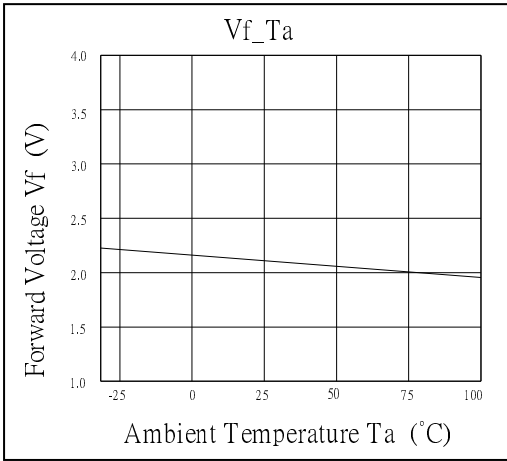
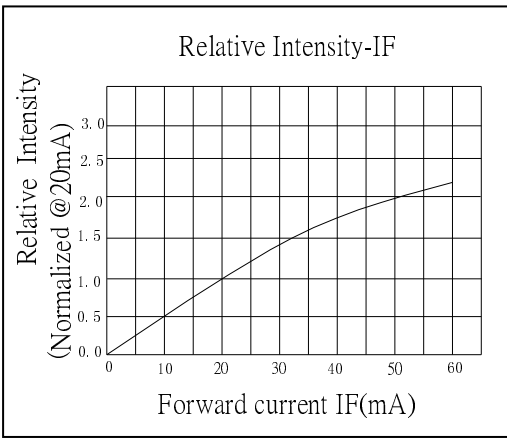
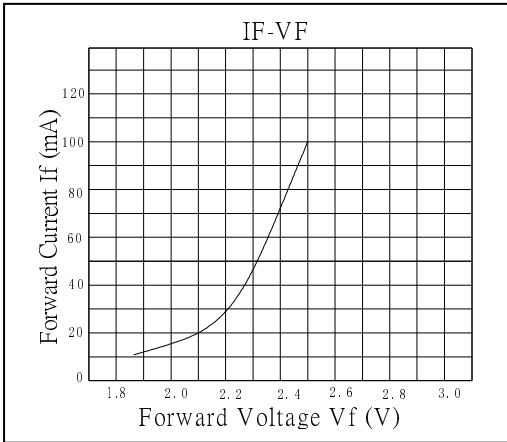

AlGaInP LED

TYPICAL ELECTRICAL/OPTICAL CHARACTERISTIC CURVES

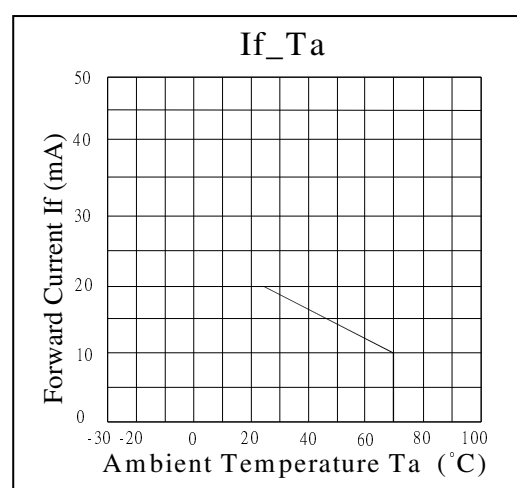
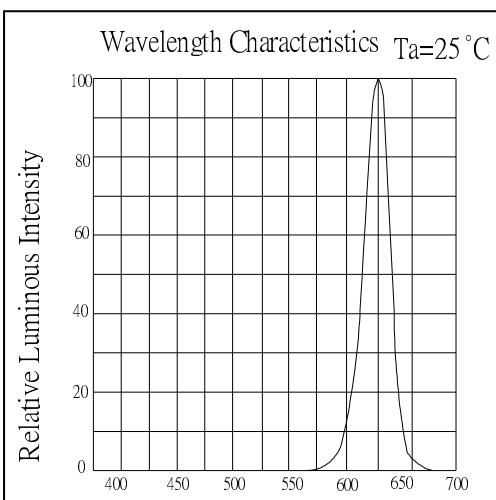
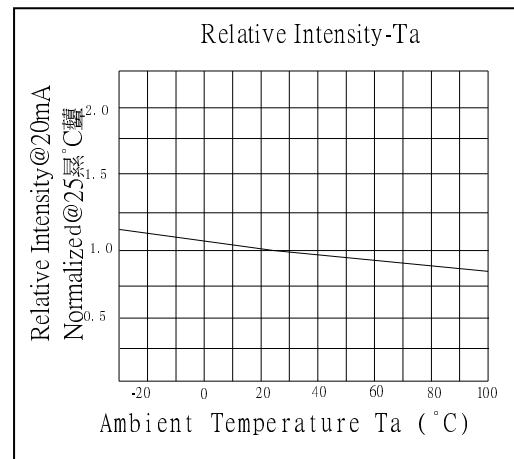
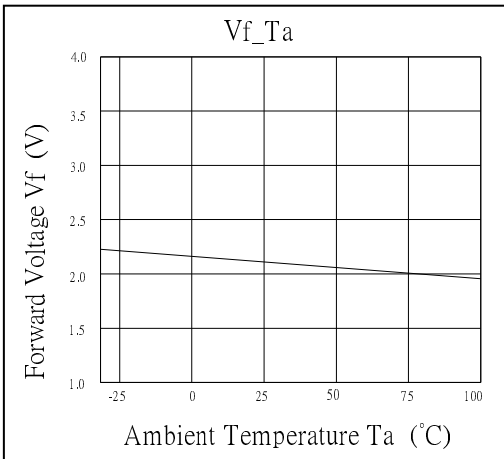
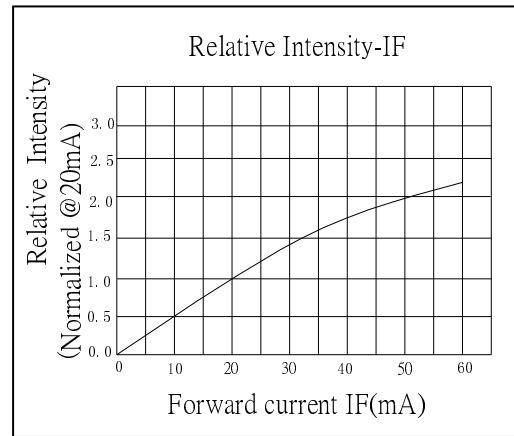
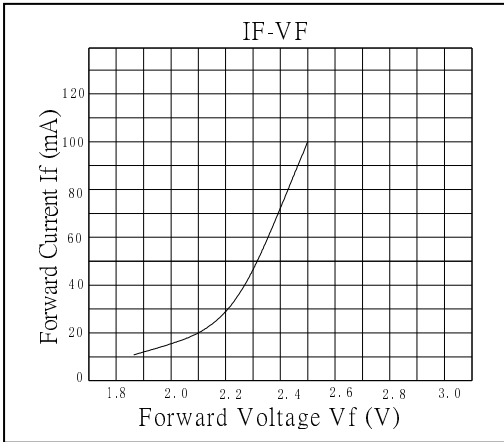

AlGaInP LED

TYPICAL ELECTRICAL/OPTICAL CHARACTERISTIC CURVES

