

**■Features**

- Highest Luminous Flux
- Super Energy Efficiency
- Long Lifetime Operation
- Superior UV Resistance

**■Applications**

- Read lights (car, bus, aircraft)
- Portable (flashlight, bicycle)
- Bollards / Security / Garden
- Traffic signaling / Beacons
- In door / Out door Commercial lights
- Automotive Ext

**■Outline Dimension**

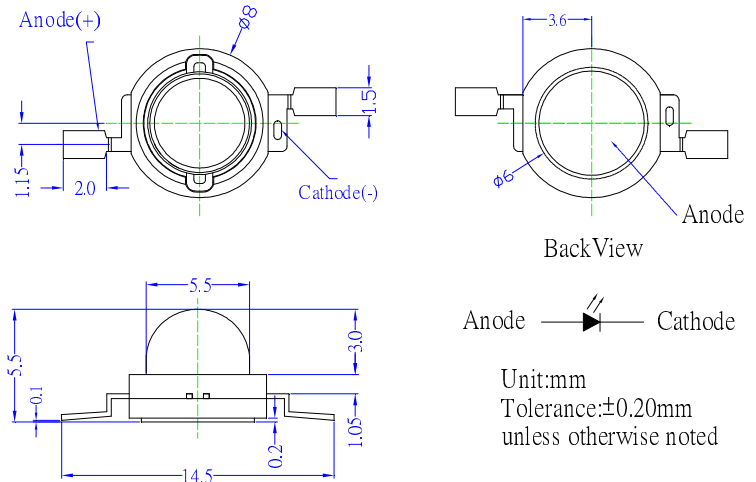

**■Absolute Maximum Rating**

(Ta=25°C)

Item	Symbol	Value	Unit
DC Forward Current	I <sub>F</sub>	400	mA
Pulse Forward Current#	I <sub>FP</sub>	500	mA
Reverse Voltage	V <sub>R</sub>	5	V
Power Dissipation	P <sub>D</sub>	1200	mW
Operating Temperature	Topr	-30 ~ +85	°C
Storage Temperature	Tstg	-40~ +100	°C
Lead Soldering Temperature	Tsol	260°C/5sec	-

**■Directivity**

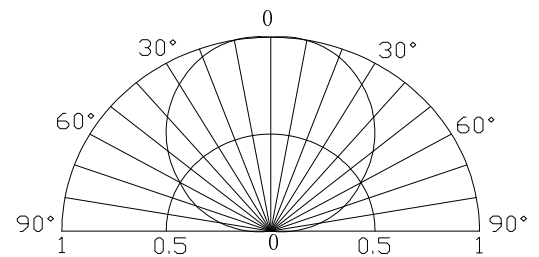

#Pulse width Max.10ms Duty ratio max 1/10

**■Electrical -Optical Characteristics**

(Ta=25°C)

Item	Symbol	Condition	Min.	Typ.	Max.	Unit
DC Forward Voltage*1	V <sub>F</sub>	I <sub>F</sub> =350mA	2.0	2.5	3.0	V
DC Reverse Current	I <sub>R</sub>	V <sub>R</sub> =5V	-	-	10	μA
Domi. Wavelength*2	λ <sub>D</sub>	I <sub>F</sub> =350mA	585	590	595	nm
Luminous Flux*3	Φ <sub>v</sub>	I <sub>F</sub> =350mA	40	50	-	lm
50% Power Angle	2θ <sub>1/2</sub>	I <sub>F</sub> =350mA	-	120	-	deg

\*1 Tolerance of measurements of forward voltage is ±0.1V

\*2 Tolerance of measurements of dominant wavelength is ±1nm

\*3 Tolerance of measurements of luminous Flux is ±15%

Note: Don't drive at rated current more than 5s without heat sink for Xeon 1 emitter series.

**AlGaInP LED**

**TYPICAL ELECTRICAL/OPTICAL CHARACTERISTIC CURVES**

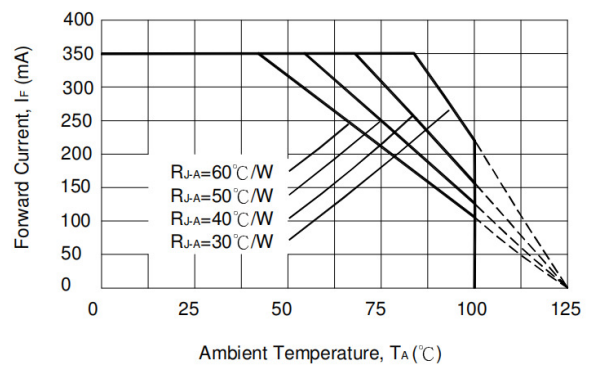
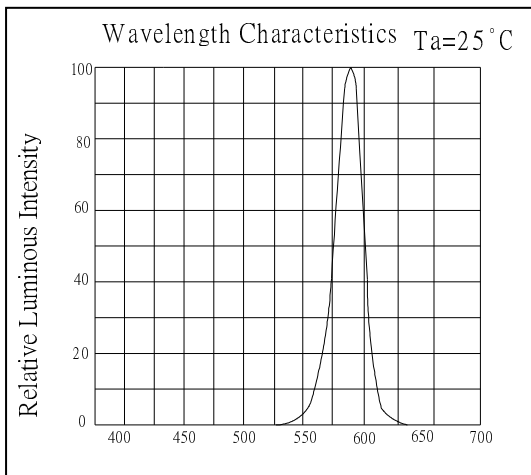
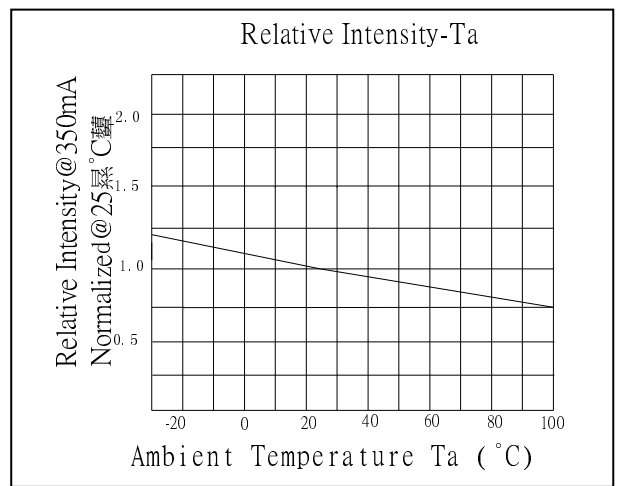
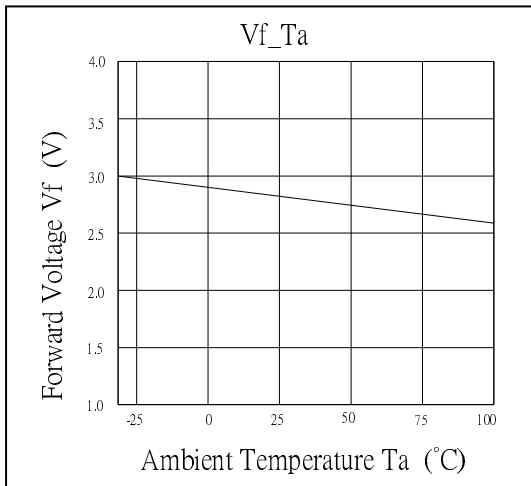
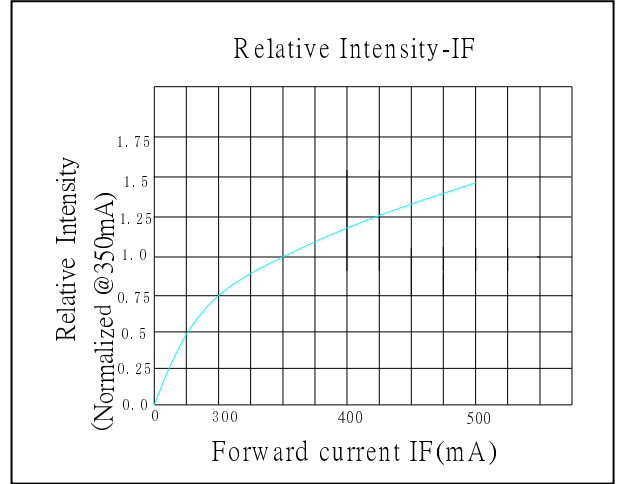
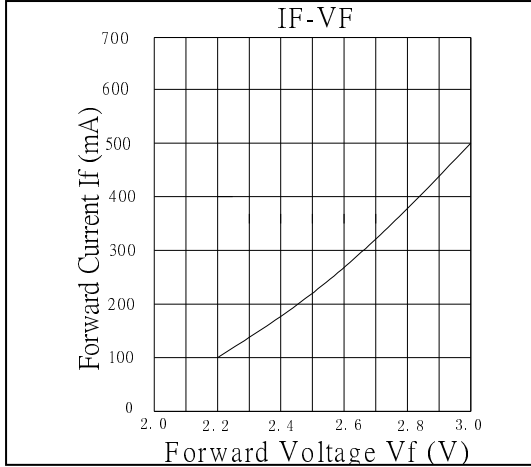

■ **Soldering Heat Reliability :**

Reflow soldering Profile

- Reflow soldering should not be done more than two times.
- When soldering, do not put stress on the LEDs during heating.
- After soldering, do not warp the circuit board.
- Repairing should not be done after the LEDs have been soldered. When repairing is unavoidable, a double-head soldering iron should be used. It should be confirmed beforehand whether the **characteristics of the LEDs will or will not be damaged by repairing.**

Solder
Average ramp-up rate = 3°C/sec. max.
Preheat temperature: 150°~180°C
Preheat time = 120 sec. max.
Ramp-down rate = 6°C/sec. max.
Peak temperature = 220°C max.
Time within 3°C of actual peak temperature = 25 sec. max.
Duration above 200°C is 40 sec. max.

