

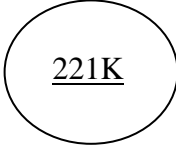

DISC CERAMIC CAPACITOR

Part No. : RDDA221K1H5L1

MECHANICAL :

- Thickness (T) : 3.5 mm Max.
- Lead Diameter : 0.52 mm ± 0.05 mm
- Soldering Test : 250 °C ± 5 °C
- Pulling Test : 2 KG
- Marking : 

CP Wire

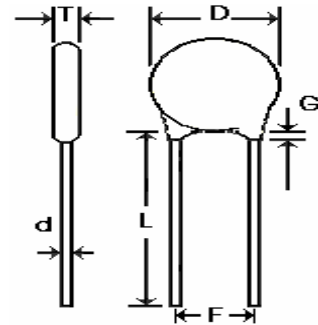

ELECTRICAL :

- Capacitance : 220PF
- Capacitance Tolerance : + - 10 %
- Q or DF : 0.025 Max.

External Dimensions (D)	5mm ± 1mm
Lead Spacing (F)	5mm ± 0.8mm
Thickness (T)	3.5mm Max.
Lead Length (L)	25mm ± 3mm
Lead Diameter (d)	0.52mm ± 0.05mm
Lead Coating (G)	1.5mm Max.

- Insulation Resistance : ≥ 10000MΩ
- Working Voltage : 50 V DC
- Dielectric Withstanding : 125 V DC for 1~5 sec

Temperature Characteristic :

According to EIA Y5E The Capacitance change of +4.7 - 4.7 %
between the temperature range of - 25 °C ~ + 85 °C

TESTING INSTRUMENTS :

- 1 . TEMPERATURE COMPENSATING TYPE : HP4278A
- 2 . HIGH DIELECTRIC TYPE : HP4265A

TESTING CONDITIONS :

- Testing Frequency : 1MHz
- Testing Voltage : 1.0Vrms

* Remarks: Withstand voltage below 100VDc, all need to comply with the manufacturing specifications of Coating's non-leakable silver electrode