

# RF Explorer®

## RF Explorer Near Field RFEAH-25 Antenna Datasheet

### Description

RF Explorer RFEAH-25<sup>1</sup> is a 25mm diameter, high performance near field H-Loop antenna.

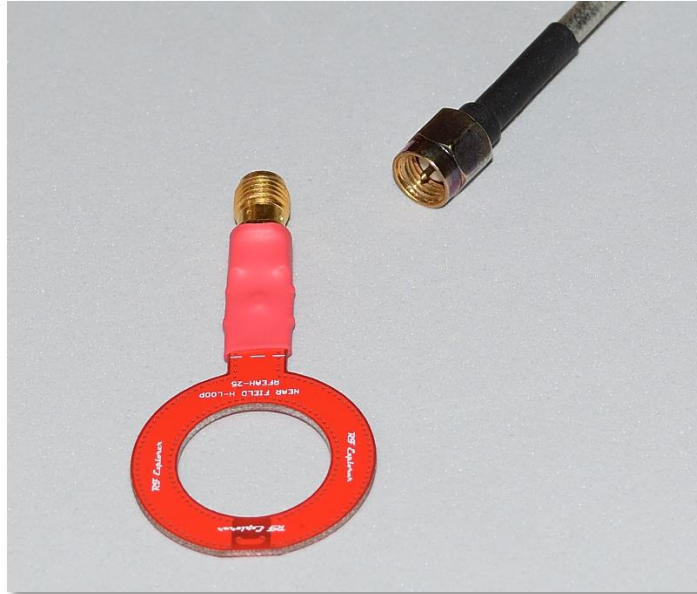

RFEAH-25 is a very sensitive, compact and easy to use H-loop near field antenna. The low-loss design exhibits at least 10dB more sensitivity in the range 20-6000MHz than other H-loop options in the market, at a much lower cost.

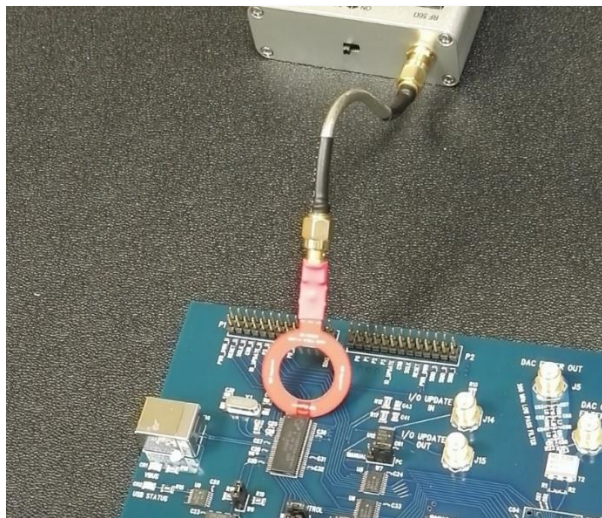

Compared with other near field antennas, RFEAH-25 is smaller and lighter, exactly what fits best when space is constrained in a PCB.

Included with the antenna is high quality semi-flexible RF cable, this cable works as the handler of the antenna.

The big advantage of this approach: you can shape the cable the way you want for the antenna to be located exactly where you need it, in most cases with no need to hold it in your hand.

<sup>1</sup> Note: First production batch defined the antenna reference name as RFEAN25, whereas second and newer batches renamed as RFEAH-25. Except from CNC cut details on PCB edge (smoother in 2<sup>nd</sup> and newer batch), both antennas are identical. They both have same electrical performance.



## RF Explorer Near Field RFEAH-25 Antenna Datasheet

### Features

- Robust calibrated low cost H-loop near field antenna
- Can work with RF Explorer Spectrum Analyzer, Signal Generator and other RF instruments and devices
- Easy to use, reliable to find interference sources with high accuracy and resolution
- Can be used to detect hidden bugs and transmission sources with great spatial resolution
- Feasible to generate interferences with Signal Generator and confirm RF circuit sensitivity
- Capable of pre-EMC compliance tests

### Specification

- Connector: SMA female
- High frequency RF SMA Male-Male included
- Type: H-loop near field
- Characterized response: 20MHz to 7Ghz
- RoHS compliant

### Package contents

- 1 x RFEAH-25 H-loop near field antenna
- 1 x Semirigid SMA Male-Male RG402 10cm 6GHz cable

# RF Explorer<sup>®</sup>

## RF Explorer Near Field RFEAH-25 Antenna Datasheet

### Applications

- **Detect radiation:** Easily determine the electronic component or PCB signal track creating a wanted or unwanted RF radiation.
- **Sniff and measure:** Follow signal path in any RF or high speed digital circuit, with no need to actually contact the circuit itself.
- **Find bugs:** Thanks to great spatial resolution, it is ideal antenna to check for RF bugs such as hidden cameras or microphones in a room.
- **Diagnose EMI:** Check any electronic device for RF radiation limits. This may include a connector with leakage, a module creating interference in a drone or RC plane, an oscillator or crystal that may not be working at the right frequency, etc.
- **Pre-compliance EMC testing:** Help on finding possible sources of interference in a design before passing an expensive EMC lab test for approval EU / FCC.
- **Create interference:** it can be used to introduce RF interference in specific areas of a circuit or device, to check on side effects as well as diagnose root cause of intermittent problems. Connect it to a Signal Generator and use CW or Frequency Sweep to check how your circuit respond.
- **Multi-tool:** RFEAH-25 can be used with RF Explorer Spectrum Analyzer and Signal Generator. But it can be used with any spectrum analyzer brand, as well as oscilloscopes. It is DC decoupled up to 25V so pretty much risk free if makes contact with the PCB circuit under test.

To correctly use the antenna and receive maximum sensitivity, please observe the following suggestions:

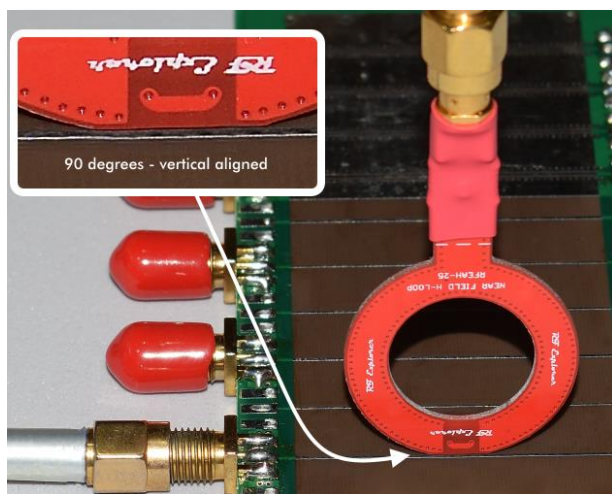

The H-Loop antenna works basically as an inductive coil, capturing magnetic flux. Therefore, it should be oriented in such a way the maximum magnetic field is captured.

In most cases, that means you should place the antenna vertical to the signal trace, as show in this picture.

# RF Explorer<sup>®</sup>

## RF Explorer Near Field RFEAH-25 Antenna Datasheet

Avoid using the antenna orthogonally to a signal trace, as otherwise will mostly miss the magnetic field involved and will present very low sensitivity.

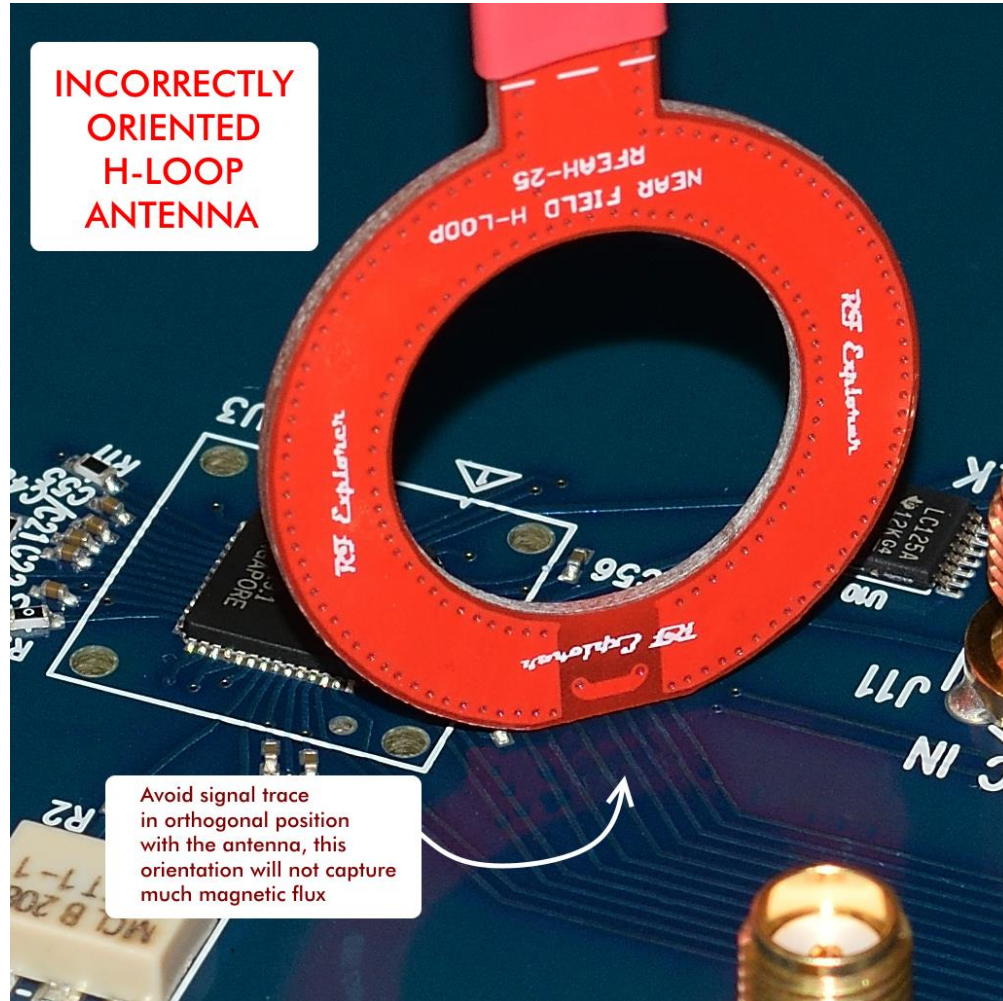

# RF Explorer<sup>®</sup>

RF Explorer Near Field RFEAH-25 Antenna Datasheet

## Characterized Frequency Response

Coupling data graph provided include response for FR4 PCB thickness (0.010", 0.020", 0.032" and 0.064"), tested and calibrated with a 50ohm impedance Microstrip signal trace, using SOLT calibrated VNA. This approach provides a repeatable, quality coupling calibration data set to efficiently use the antenna for PCB signal measurements.

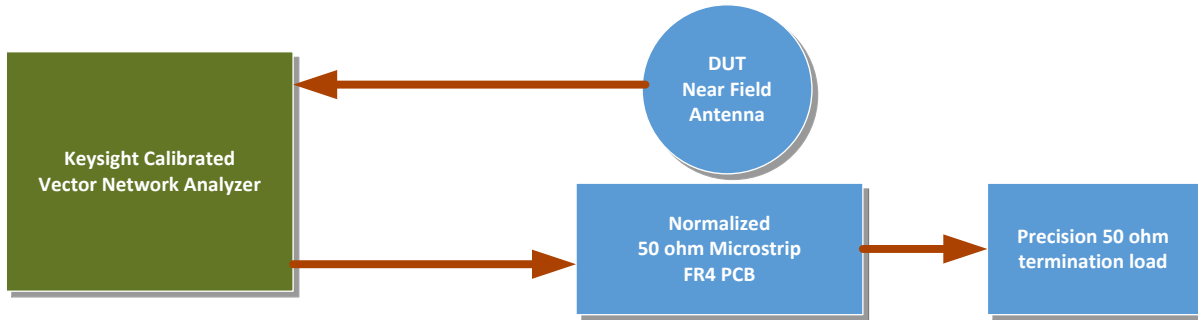

The antenna must be vertical 90 degrees against PCB signal trace, at 0mm distance, parallel horizontal orientation to signal trace for maximum sensitivity of the magnetic flux, as depicted below.

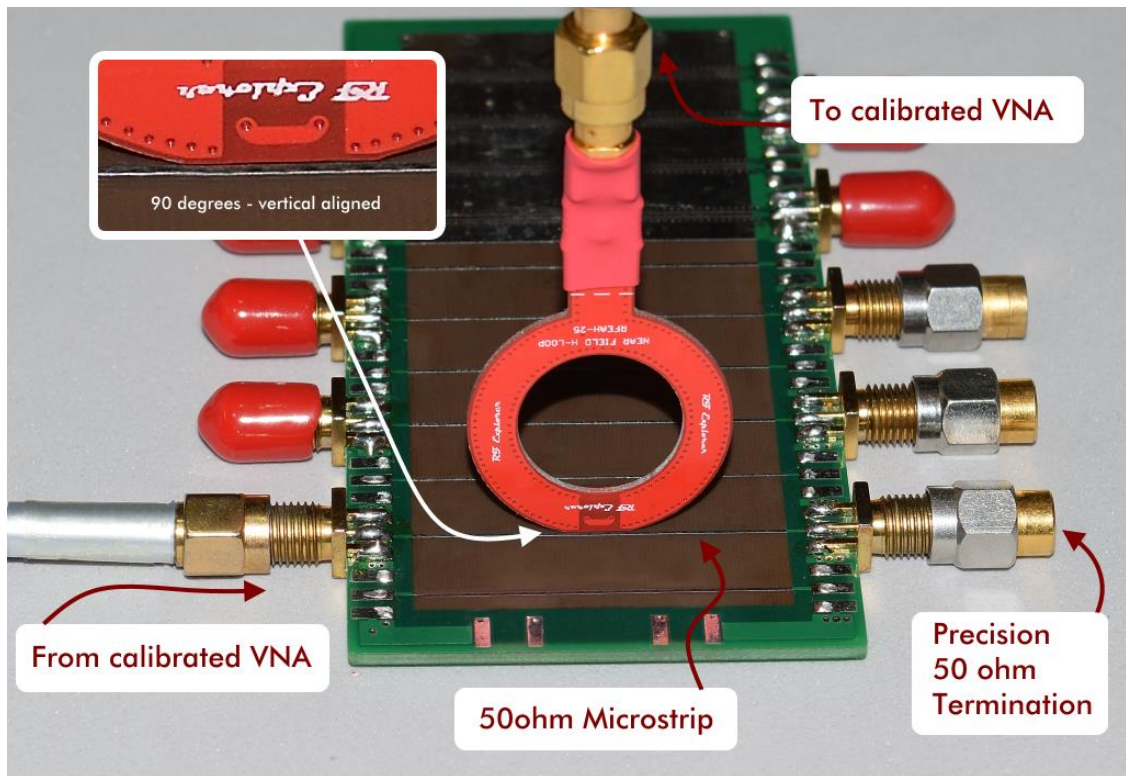

# RF Explorer®

## RF Explorer Near Field RFEAH-25 Antenna Datasheet

### Using coupling amplitude calibration with RF Explorer for Windows

One important advantage of using calibrated antennas is the automatic adjustment available in RF Explorer for Windows application.

Using this feature and calibration files provided, the application will automatically display the real signal power level in the Microstrip trace.

Calibration files are available for download and are very easy to use:

- Download files from [www.rf-explorer.com/downloads](http://www.rf-explorer.com/downloads)
- Decompress file contents and store all \*.RFA files in a folder of your choice. The recommended path is the folder directly pointed by %appdata%\RFExplorer – this is the same folder used by other calibration files.

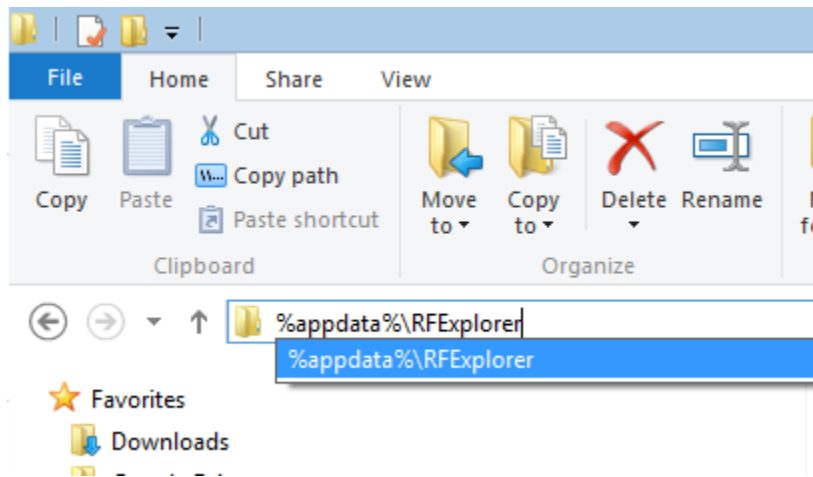

- To enable calibration of a specific antenna model in RF Explorer for Windows, open menu *File -> Load amplitude correction file...* and select it. For instance to use the RFEAH-25 antenna to detect a signal on a 32mil PCB (0.8mm) load file RFEAH25\_32mil.rfa

- Make sure the *Autoload model amplitude correction data* option is **unchecked**, and *Use amplitude correction data* is **checked**.

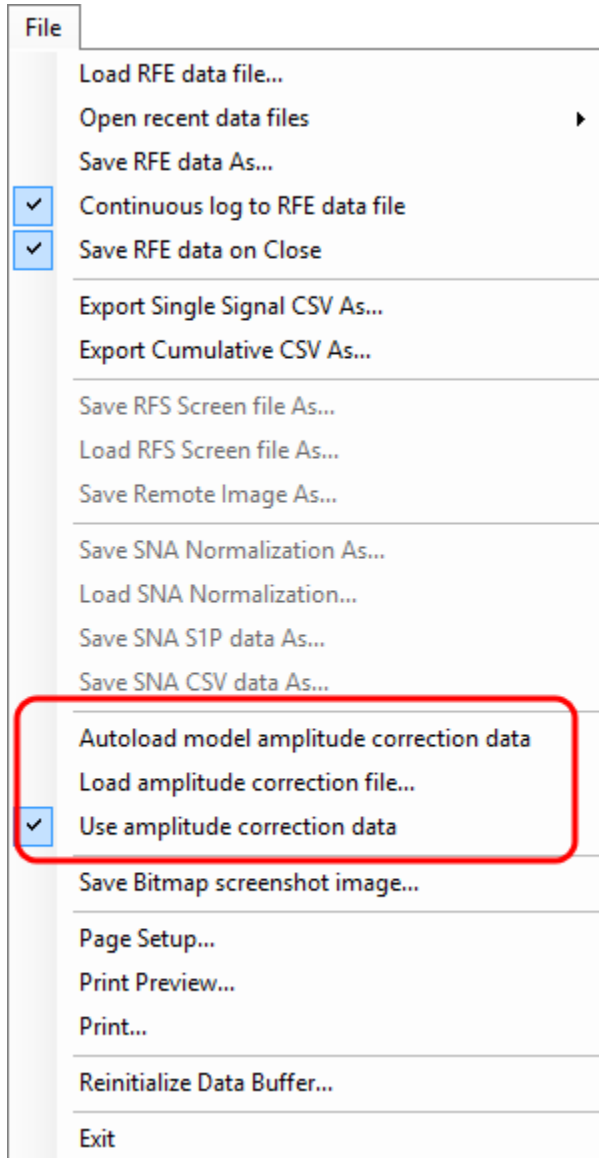

With this configuration, the noise floor will increase to adjust for actual reading. The sensitivity is also adjusted to that of the antenna, and therefore direct amplitude readings makes signal trace power measurement a breeze.

Note: several factor may add extra attenuation to the measurement, including trace length, antenna orientation, and trace impedance. All the antennas are calibrated using matched impedance traces but that is not always the case in a PCB under test. Additionally, grounded coplanar waveguide may produce different results than Microstrip, used for calibration.

### Coupling 1-250MHz

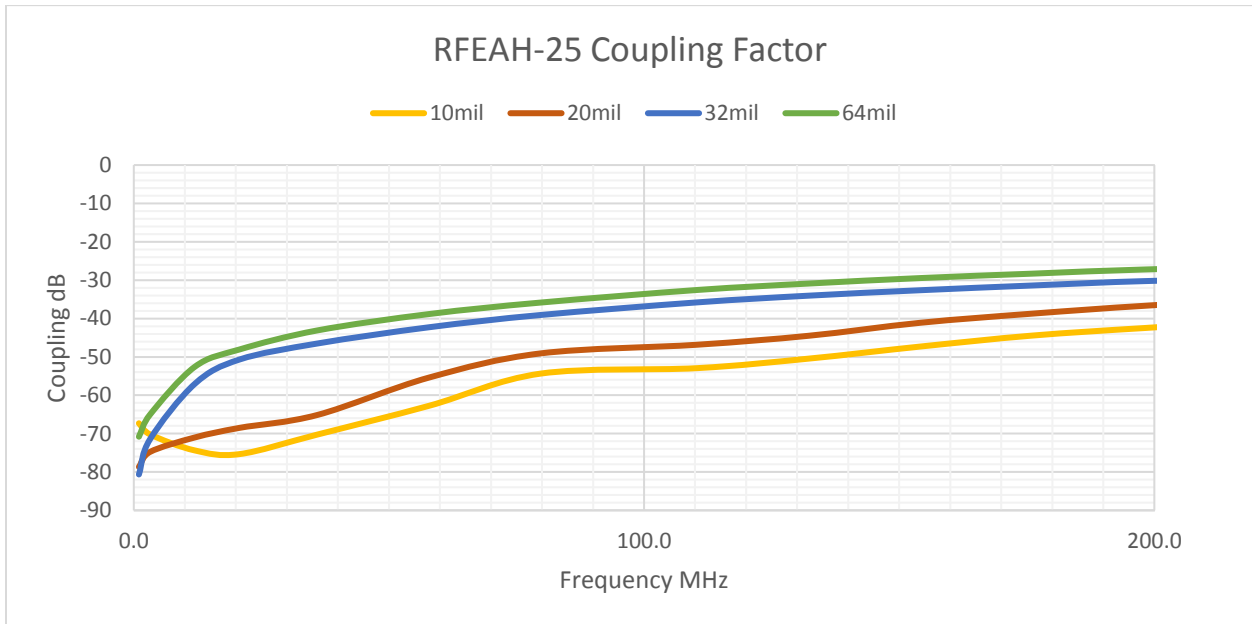

### Coupling 1000MHz

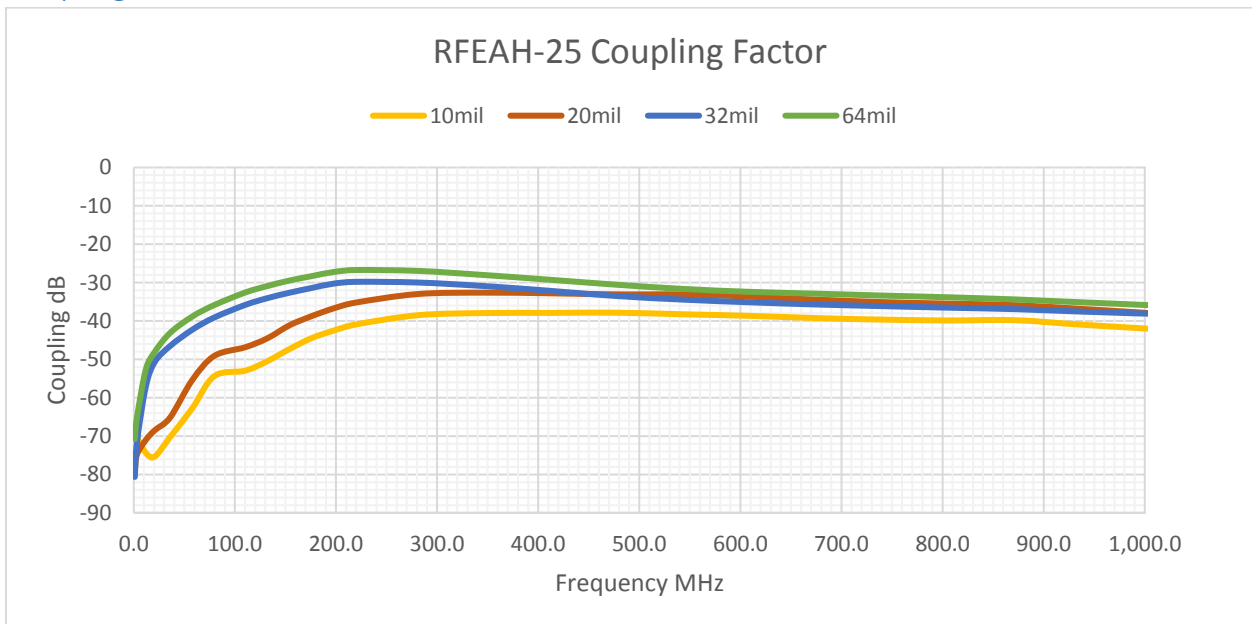



## Coupling 7GHz

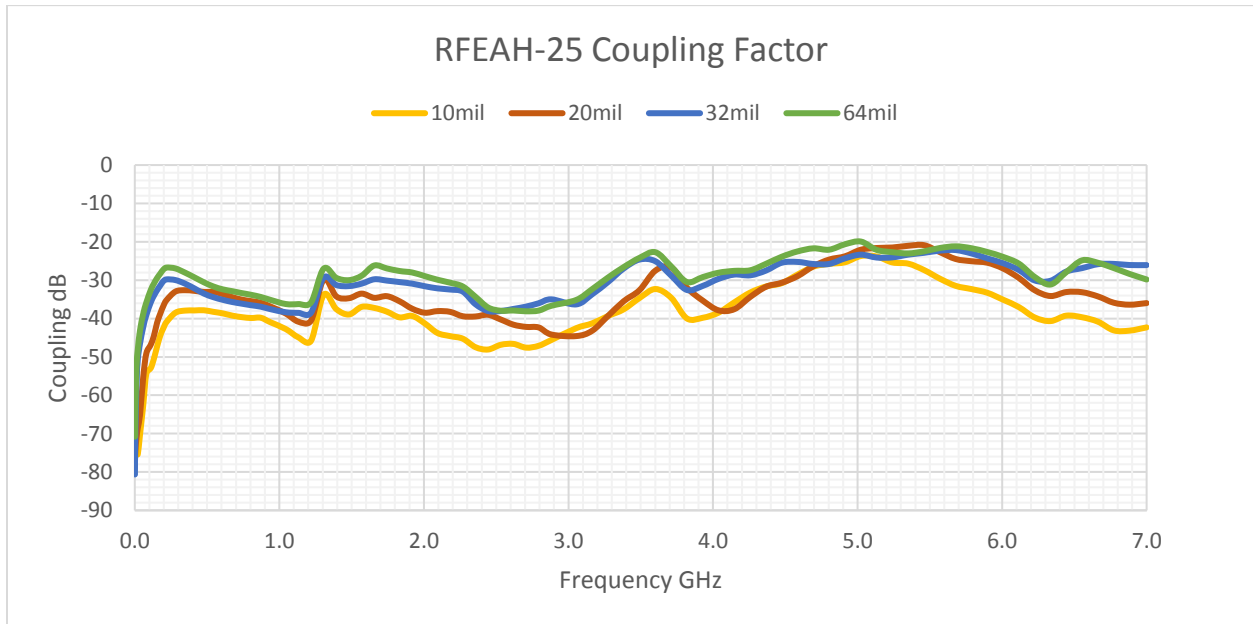



## Revision History

Version	Date	Comments
0.1 DRAFT	2016-11-01	Preliminary version including calibrated coupling data
1.0	2016-11-29	Final version with corrected graphical chart data
1.1	2017-01-13	Updated coupling data plot averaging additional antenna samples from 2 <sup>nd</sup> batch, and using a more repeatable VNA method. Measurement for 0.031" and 0.062" are pending for additional tests.
1.2	2017-03-22	Updated averaged coupled reference chars for 10mil, 20mil, 32mil and 64mil FR-4 substrate Microstrip

## Table of Contents

Description .....	1
Features .....	2
Specification.....	2
Package contents .....	2
Applications.....	3
Characterized Frequency Response.....	5
Using coupling amplitude calibration with RF Explorer for Windows .....	6
Coupling 1-250MHz.....	8
Coupling 1000MHz.....	8
Coupling 7GHz.....	9
Revision History .....	10