



# SUPERTECH ELECTRONIC CO., LTD.

No.1, Lane 55, Rixin St., East Dist., Chiayi City 60066, Taiwan (R.O.C.)

TEL: 886-5-2782796 (REP) FAX: 886-5-2786786 (REP)

Website: www.supertech.com.tw

Email: supertec@ms5.hinet.net supertech@supertech.com.tw



# 規格承認書

## *Specification Acceptance Document*

### 客戶資料 Customer Information

- 客戶 Customer: AKIZUKI DENSHI TSUSHO CO., LTD
- 客戶機種型號 Customer Model NO :

客戶承認簽印 Customer Approval Status :

簽核 SIGNATURE :

*PLEASE SIGN AND RETURN ONE COPY. 確認後請回簽一份並加蓋公司章。*



### 資料 Information

- 規格型號 Our Model : SL4515G-B103L15CM
- 圖面編號 Drawing NO : SLV5-014
- 數量 Quantity : 0 PCS
- 備註 Remark :
- 日期 Date : 2019.12.17

客戶 Customer : AKIZUKI DENSHI TSUSHO CO., LTD

規格型號 Model : SL4515G-B103L15CM

一般事項 General	
使用溫度範圍 Operating temperature	-10 °C ~ +70 °C
手工焊接 Manual soldering	300 °C max 3 sec
電氣特性 Electrical Characteristics	
總阻值 (R) Total resistance	10 KΩ
總阻值容許誤差 Total resistance tolerance	± 20 % ( more than 1 MΩ ± 30 % )
阻值線性 Resistance taper	3B
摺動雜音 Sliding noise	Less than 100mV at 20mm/sec
殘留阻值 Residual resistance	Less than 20 Ω
定格電力 Rated power (W)	Linear (B) taper: 0.1 W Other tapers: 0.05 W
額定電壓 Rated voltage (V)	$E = \sqrt{P * R}$ E: Rated voltage 額定電壓 (V) P: Power rating 額定電力 (W) R: Nominal total resistance 公稱全阻抗值 (Ω) 當額定電壓超過最高使用電壓的時候，最高使用電壓即為額定電壓。 When the rated voltage exceeds the maximum operating voltage, the maximum operating voltage shall be the rated voltage.
最高使用電壓 Max operating voltage	Linear (B) taper: AC 100 V Other tapers: AC 50 V
絕緣阻抗 Insulation resistance	More than 100 MΩ at DC 250 V
耐電壓 Withstand voltage	1 minute at AC 300 V
相互偏差 Gang error	-40 dB ~ 0 dB ≤ 3 dB
機械特性 Mechanical Characteristics	
滑動行程 Travel length	45mm ± 0.5 mm
滑動力距 Operating force	30 ~ 200 gf.cm
C.C 扭力 C.C torque	□ 50 ~ 350 gf.cm
作動止強度 Stopper strength	5 Kgf.cm max
軸推拉強度 Shaft push-pull strength	3 Kgf max
滑動壽命 Sliding life	15,000 cycles

核准 Approval	審核 Auditing	校對 Checked	制作 Projected
			

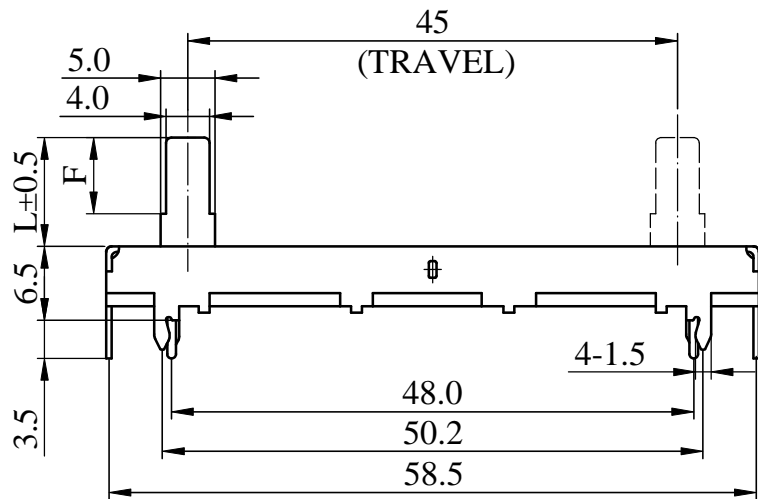
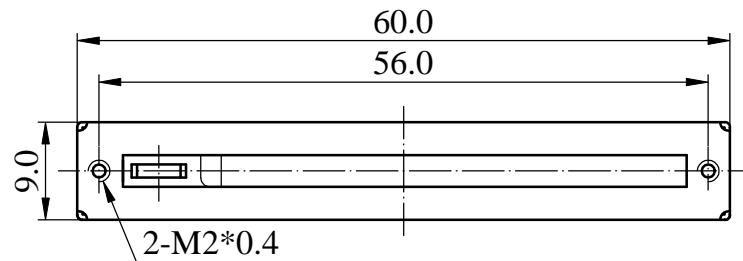

Mounting Hole

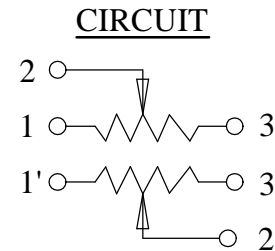
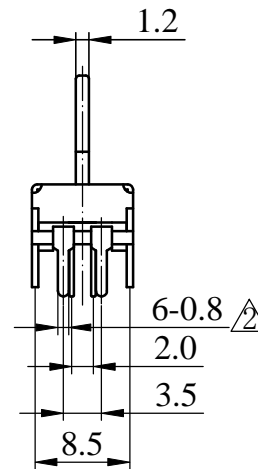
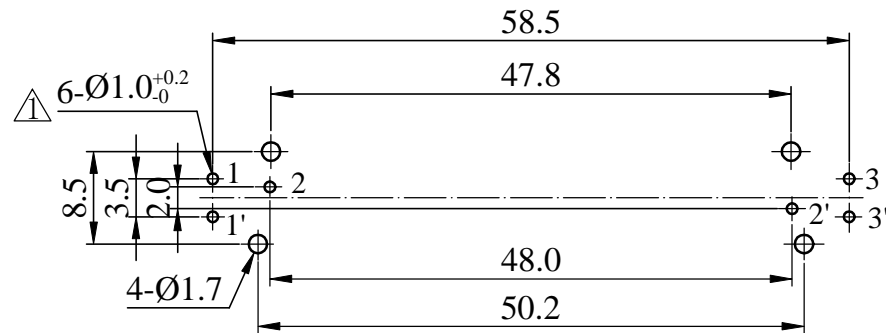

		Non notation tolerance	
L=	10 15 17.3 20 25	< 10	±0.3
F=	7 10 10 10 10	10 ~ 100	±0.5
choose		> 100	±0.8



**Supertech Electronic Co., Ltd.**

MODEL: SL4515G(C)/M

Approval



Checked



Projected



UNIT	mm	SCALE	1.5:1
VERSION	1.4	DATE	2008.06.17
DRAWING NO.	SLV5-014		

	整理图元	何鸿根	2019.01.02
	修改电路图	何鸿根	2017.12.21
	原1改0.8	何鸿根	2017.11.23
	增加公差 <sup>+0.2</sup> <sub>0</sub>	何鸿根	2017.8.21
ISSUE	SUBJECT	NAME	DATE

RECORD

# STANDARD RESISTANCE TAPER(電位器專用)

TAPER B Series

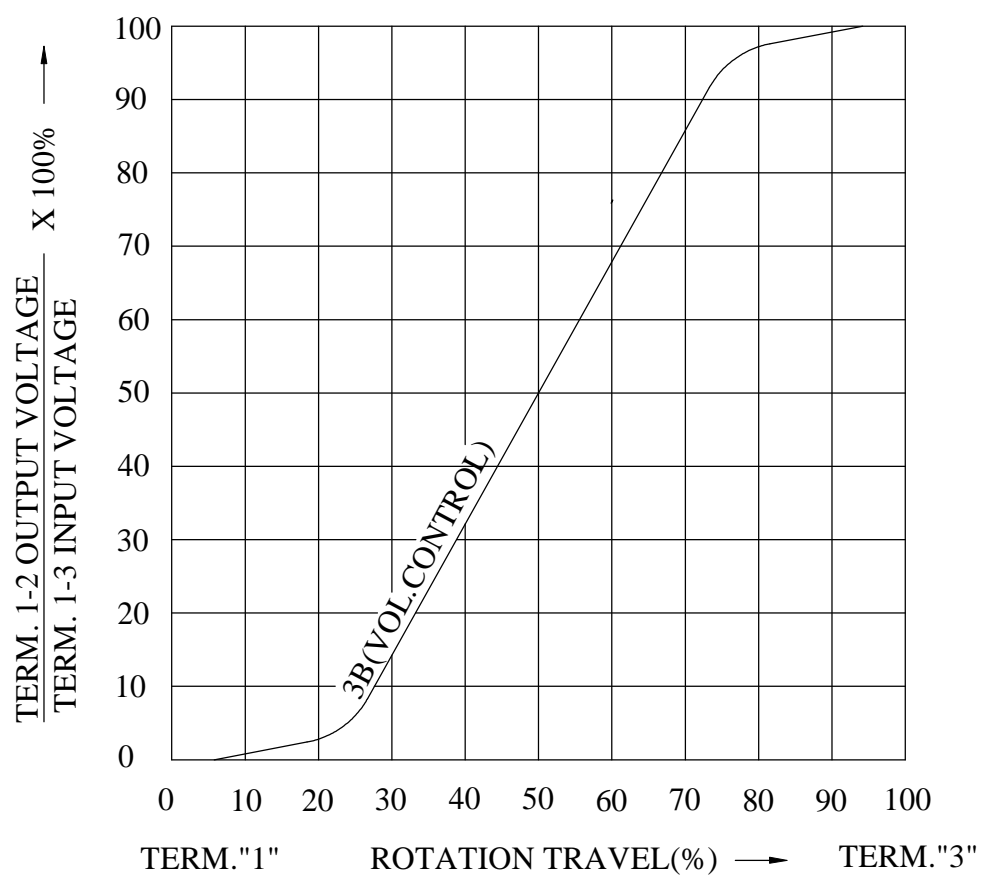

3B



## CAUTION 可變電位器使用注意事項(1/2)

### 1. 謹慎使用化學品：

電位器因使用了諸如聚碳酸酯等合成樹脂，所以應避免將電位器暴露於氨、胺、鹼溶液、芳烴酮、酯、鹵烴等化學物品濃烈氣體中。

### 2. 謹慎使用助焊劑：

焊錫時應避免使用水溶性助焊劑，否則將會對組成電位器的金屬和其他材料產生不良影響。

### 3. 焊錫：

佈線和焊錫方法應避免導致(如圖 1)所示，熔錫流到 PC 板上平面，這樣會引起接觸不良。

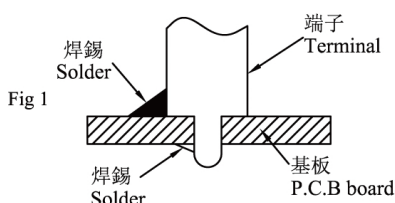

### 4. 推薦的電路接法：

電位器作為可變電阻器使用時，建議作調整電壓的分壓器使用(見圖 2)。我們不建議電位器用於電流調整，容易有問題產生(見圖 3)。但電路設計上，如果允許電流通過電位器的滑動臂，此時電阻值異常增加，容易導致陽極氧化。在這種情況下，建議將連接電阻體的端子接負極，滑動臂接正極(見圖 4)。

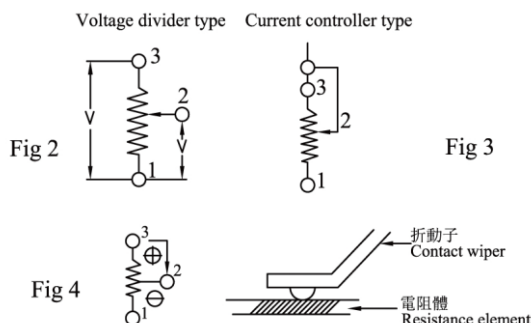

### 5. 殘留電阻：

儘管電位器電阻體二極是印刷銀層，但為了提高抗硫化的可靠性，通常在電阻體二極覆蓋一層碳膜，如果希望低殘留電阻，請與本公司聯繫。

### 6. 避免水氣或水滴：

電位器在使用過程中，電阻體表面應避免有水氣或水滴產生，否則，將導致絕緣電阻惡化或短路。

### 1. Use of Chemicals :

Synthetic resins such as polycarbonate are used in the potentiometer. Therefore, the resistor must not be exposed to thick chemical atmospheres such as ammonia, amine, alkali solution, aromatic, hydrocarbon, ketons, esters, halogenous, hydrocarbons.etc.

### 2. Use of flux :

When soldering, avoid using water-soluble flux. Otherwise, it might cause an adverse effect on molding materials and metal.

### 3. Soldering :

Avoid wiring and soldering that causes solder to flow out the surface of PC board, as illustrated in the schematic drawing Fig.1. This could cause a contact failure.

### 4. Recommended circuit configuration :

When using variable resistors, we recommend to use it as a voltage adjusting, as show in Fig 2. We do not recommended to use the variable resistor as a current adjusting, as shown in Fig 3. It is very possible to cause a problem because of contact resistance between resistive element and sliding arm.

In applications where a direct current is allowed to flow through the potentiometer's sliding arm, there could be a problem of anodic oxidation because of an unusual increase in resistance value. In such case, we recommended to connect the negative line to the resistance element and the positive line to the sliding arm. Please see Fig 4.

### 5. Residual resistance :

Although electric poles of resistors are generally formed by silver printing, we provide carbon coating over the silver poles to enhance reliability against sulfurization. Contact us if you wish to use the part in a low residual resistance state.

### 6. Dew condensation :

Avoid using the potentiometer where dew or water drops might occur on the surface of the resistor, etc. Deterioration of insulation or shorting may occur.

## CAUTION 可變電位器使用注意事項(2/2)

### 7. 施加於端子壓力：

手拿端子時應特別注意避免過分用力，同時應設計正確的焊錫條件。

### 8. 軸的徑向搖動：

當使用長度過長的軸心時，其徑向晃動量將與軸長成正比，應按實際需要選用軸長。

### 9. 面板安裝：

當電位器是用螺母安裝於面板時，過緊將使旋轉接觸功能失效或螺紋滑牙，鎖螺母時應非常小心。

### 10. 低溫工作：

當產品用於低溫環境時，如寒帶的汽車收音機或音響等，本公司按客戶要求提供手感舒適產品，請訂貨時加以說明。

### 11. 滑柄長度：

在情況允許下，軸心長度越短越好(至少 5mm)。在軸心底座的寬度 A 不變的情況下，軸心長度(H)愈短，手感愈好，另外出力點愈高，手感愈差(如圖)。

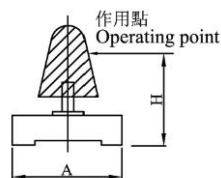

### 12. 驅動臂：

建議勿使用操作點遠離滑柄中心線，基於上述同樣理由，B 的距離越短越好(如圖)。

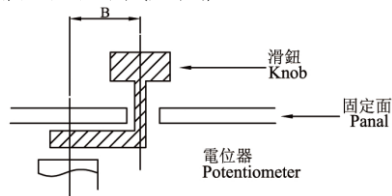

### 13. 保管方式：

- (1) 產品以交貨時的狀態在常溫、常濕，不受直射陽光照射，不產生腐蝕性氣體的场所保管，自交貨起 6 個月以內為限度，請儘快使用。
- (2) 開封後用聚乙烯與外氣隔絕，請在與上述相同環境下保管，並儘快使用。

### 7. Stress being applied to the terminals :

Care must be taken not to apply excessive stress when handing the terminals. Also, be sure to design appropriate soldering conditions.

### 8. Looseness of the shaft :

When long shaft is being employed, the looseness (deviation) tends to grow in proportion to the shaft length. Conducting a test under actual operating conditions is recommended.

### 9. Chassis mounting :

When this part is fastened to the chassis using a nut, excessive tightening may deteriorate the rotary contact performance, or strip the threads. Exercise care when tightening the nut.

### 10. Operation at low temperature :

When these products are expected to be used under low temperature environments such as applications for car radios or car stereos, we can customize them for easy and smooth rotary movements. When placing orders, indicate whether the low temperature specification is necessary or not.

### 11. Lever length :

If conditions permit, it is recommended to use the shortest possible lever (at least 5mm) for the application. Since the length A of the slider is constant as shown, the shorter the operating point, the better slide feeling. The longer the operating point like H, the more unfavorable slide feeling.

### 12. Driving lever :

It is recommended that not to make the operating pint away from the center line of the lever as shown. For the same reason as mentioned above, the shorter the length B, the better slide feeling will be obtained.

### 13. Storage :

- (1) Store the products as delivered, at a normal temperature and humidity, without direct sunshine and corrosive gas ambient. Use them at an earliest possible timing, not later than six months upon receipt.
- (2) After breaking the seal, keep the products in a plastic bag to shut out ambient air, store them in th same environment as above, and use them up as soon as possible.