

Features

- Fast Switching Speed
- Surface Mount Package Ideally Suited for Automated Insertion
- For General Purpose Switching Applications
- **Totally Lead-Free & Fully RoHS Compliant (Notes 1 & 2)**
- **Halogen and Antimony Free. "Green" Device (Notes 3 & 4)**
- **Qualified to AEC-Q101 Standards for High Reliability**

Mechanical Data

- Case: SOT23
- Case Material: Molded Plastic, "Green" Molding Compound. UL Flammability Classification Rating 94V-0
- Moisture Sensitivity: Level 1 per J-STD-020
- Terminals: Matte Tin Finish annealed over Alloy 42 leadframe (Lead Free Plating). Solderable per MIL-STD-202, Method 208
- Polarity: See Diagram
- Weight: 0.008 grams (approximate)



Top View

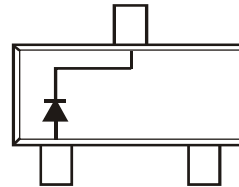

Top View
Internal Schematic

Ordering Information (Note 5)

| Part Number | Qualification | Case | Packaging |
|---------------|---------------|-------|--------------------|
| BAS16-7-F | Commercial | SOT23 | 3,000/Tape & Reel |
| BAS16-13-F | Commercial | SOT23 | 10,000/Tape & Reel |
| BAS16Q-7-F | Automotive | SOT23 | 3,000/Tape & Reel |
| BAS16Q-13-F | Automotive | SOT23 | 10,000/Tape & Reel |
| MMBD4148-7-F | Commercial | SOT23 | 3,000/Tape & Reel |
| MMBD4148-13-F | Commercial | SOT23 | 10,000/Tape & Reel |
| MMBD914-7-F | Commercial | SOT23 | 3,000/Tape & Reel |
| MMBD914-13-F | Commercial | SOT23 | 10,000/Tape & Reel |

- Notes:
1. No purposely added lead. Fully EU Directive 2002/95/EC (RoHS) & 2011/65/EU (RoHS 2) compliant.
 2. See <http://www.diodes.com> for more information about Diodes Incorporated's definitions of Halogen- and Antimony-free, "Green" and Lead-free.
 3. Halogen- and Antimony-free "Green" products are defined as those which contain <900ppm bromine, <900ppm chlorine (<1500ppm total Br + Cl) and <1000ppm antimony compounds.
 4. Product manufactured with Date Code 9W (week 39, 2009) and newer are built with Green Molding Compound. Product manufactured prior to Date Code 9W are built with Non-Green Molding Compound and may contain Halogens or Sb₂O₃ Fire Retardants.
 5. For packaging details, go to our website at <http://www.diodes.com>.

Marking Information

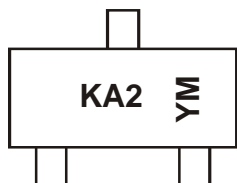

K = SAT (Shanghai Assembly / Test site)
 A2 = Product Type Marking Code
 YM = Date Code Marking
 Y = Year (ex: Z = 2012)
 M = Month (ex: 9 = September)

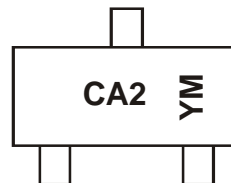

C = CAT (Chengdu Assembly / Test site)
 A2 = Product Type Marking Code
 YM = Date Code Marking
 Y = Year (ex: Z = 2012)
 M = Month (ex: 9 = September)

Date Code Key

| Year | 2002 | 2003 | | 2007 | 2008 | 2009 | 2010 | 2011 | 2012 | 2013 | 2014 | 2015 | 2016 |
|------|------|------|-------|------|------|------|------|------|------|------|------|------|------|
| Code | N | P | | U | V | W | X | Y | Z | A | B | C | D |

| Month | Jan | Feb | Mar | Apr | May | Jun | Jul | Aug | Sep | Oct | Nov | Dec |
|-------|-----|-----|-----|-----|-----|-----|-----|-----|-----|-----|-----|-----|
| Code | 1 | 2 | 3 | 4 | 5 | 6 | 7 | 8 | 9 | O | N | D |

Maximum Ratings (@T_A = +25°C, unless otherwise specified.)

| Characteristic | Symbol | Value | Unit |
|---|---------------------|-------------|------|
| Non-Repetitive Peak Reverse Voltage | V _{RM} | 100 | V |
| Peak Repetitive Reverse Voltage | V _{R(RM)} | 75 | V |
| Working Peak Reverse Voltage | V _{R(WM)} | | |
| DC Blocking Voltage | V _R | | |
| RMS Reverse Voltage | V _{R(RMS)} | 53 | V |
| Forward Continuous Current (Note 6) | I _{FM} | 300 | mA |
| Average Rectified Output Current (Note 6) | I _O | 200 | mA |
| Non-Repetitive Peak Forward Surge Current | I _{FSM} | @ t = 1.0μs | 2.0 |
| | | @ t = 1.0s | 1.0 |

Thermal Characteristics

| Characteristic | Symbol | Value | Unit |
|---|-----------------------------------|-------------|------|
| Power Dissipation (Note 6) | P _D | 350 | mW |
| Thermal Resistance Junction to Ambient Air (Note 6) | R _{θJA} | 357 | °C/W |
| Operating and Storage Temperature Range | T _J , T _{STG} | -65 to +150 | °C |

Electrical Characteristics (@T_A = +25°C, unless otherwise specified.)

| Characteristic | Symbol | Min | Max | Unit | Test Condition |
|------------------------------------|--------------------|-----|-------|------|--|
| Reverse Breakdown Voltage (Note 7) | V _{(BR)R} | 75 | — | V | I _R = 100μA |
| Forward Voltage | V _F | — | 0.715 | V | I _F = 1.0mA |
| | | | 0.855 | | I _F = 10mA |
| | | | 1.0 | | I _F = 50mA |
| | | | 1.25 | | I _F = 150mA |
| Leakage Current (Note 7) | I _R | — | 1.0 | μA | V _R = 75V |
| | | | 50 | | V _R = 75V, T _J = +150°C |
| | | | 30 | | V _R = 25V, T _J = +150°C |
| | | | 25 | | V _R = 20V |
| Total Capacitance | C _T | — | 2.0 | pF | V _R = 0, f = 1.0MHz |
| Reverse Recovery Time | t _{rr} | — | 4.0 | ns | I _F = I _R = 10mA, I _{rr} = 0.1 x I _R , R _L = 100Ω |

Notes: 6. Device mounted on glass epoxy PCB 1.6" x 1.6" x 0.06"; mounting pad for the cathode lead min. 0.93in².
 7. Short duration pulse test used to minimize self-heating effect.

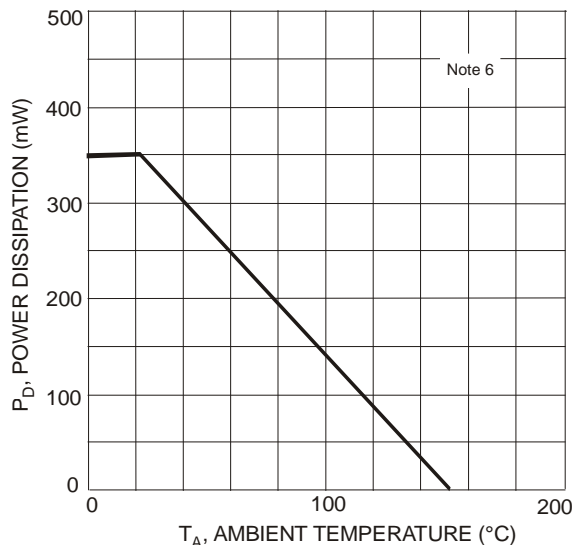

Fig. 1 Power Derating Curve

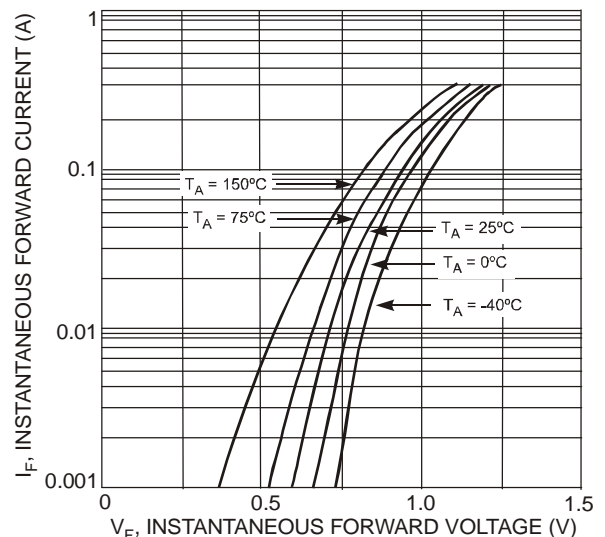

Fig. 2 Typical Forward Characteristics

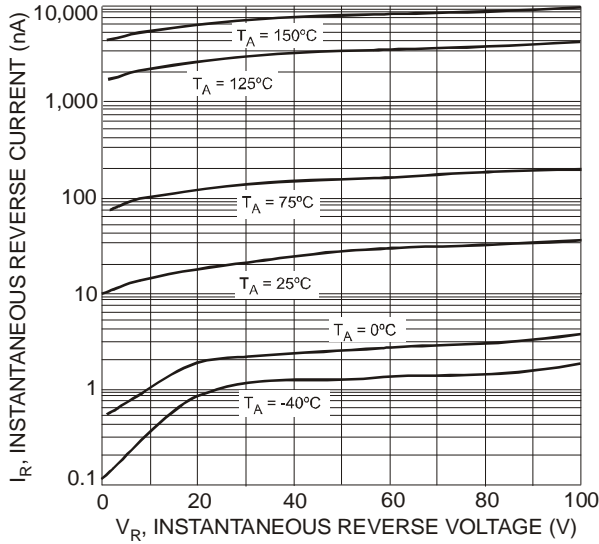

Fig. 3 Typical Reverse Characteristics

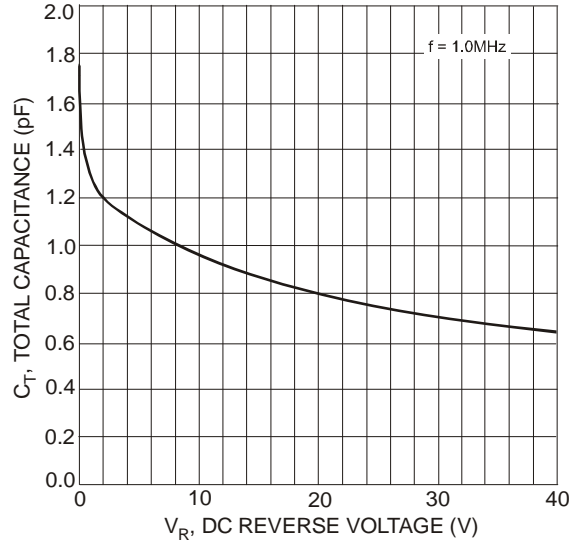
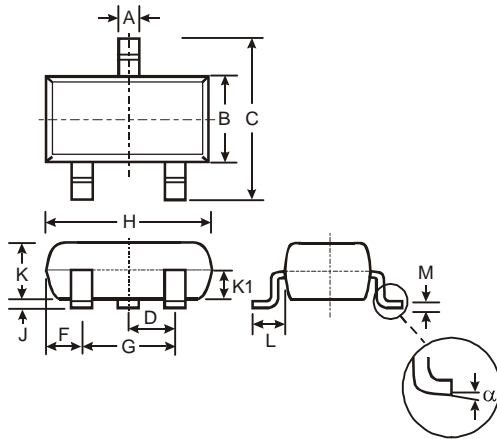

Fig. 4 Total Capacitance vs. Reverse Voltage

Package Outline Dimensions



| SOT23 | | | |
|----------|-------|------|-------|
| Dim | Min | Max | Typ |
| A | 0.37 | 0.51 | 0.40 |
| B | 1.20 | 1.40 | 1.30 |
| C | 2.30 | 2.50 | 2.40 |
| D | 0.89 | 1.03 | 0.915 |
| F | 0.45 | 0.60 | 0.535 |
| G | 1.78 | 2.05 | 1.83 |
| H | 2.80 | 3.00 | 2.90 |
| J | 0.013 | 0.10 | 0.05 |
| K | 0.903 | 1.10 | 1.00 |
| K1 | - | - | 0.400 |
| L | 0.45 | 0.61 | 0.55 |
| M | 0.085 | 0.18 | 0.11 |
| α | 0° | 8° | - |

All Dimensions in mm

Suggested Pad Layout

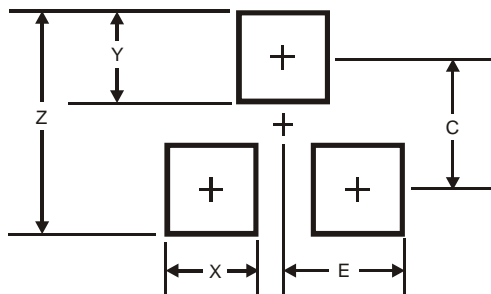

| Dimensions | Value (in mm) |
|------------|---------------|
| Z | 2.9 |
| X | 0.8 |
| Y | 0.9 |
| C | 2.0 |
| E | 1.35 |