

# IR2302(S) & (PbF) HALF-BRIDGE DRIVER

## Features

- Floating channel designed for bootstrap operation  
Fully operational to +600V  
Tolerant to negative transient voltage  
dV/dt immune
- Gate drive supply range from 5 to 20V
- Undervoltage lockout for both channels
- 3.3V, 5V and 15V input logic compatible
- Cross-conduction prevention logic
- Matched propagation delay for both channels
- High side output in phase with IN input
- Logic and power ground +/- 5V offset.
- Internal 540ns dead-time
- Lower di/dt gate driver for better noise immunity
- Shut down input turns off both channels
- 8-Lead SOIC also available LEAD-FREE (PbF).

## Description

The IR2302(S) are high voltage, high speed power MOSFET and IGBT drivers with dependent high and low side referenced output channels. Proprietary HVIC and latch immune CMOS technologies enable ruggedized monolithic construction. The logic input is compatible with standard CMOS or LSTTL output, down to 3.3V logic. The output drivers feature a high pulse current buffer stage designed for minimum driver cross-conduction. The floating channel can be used to drive an N-channel power MOSFET or IGBT in the high side configuration which operates up to 600 volts.

## Typical Connection

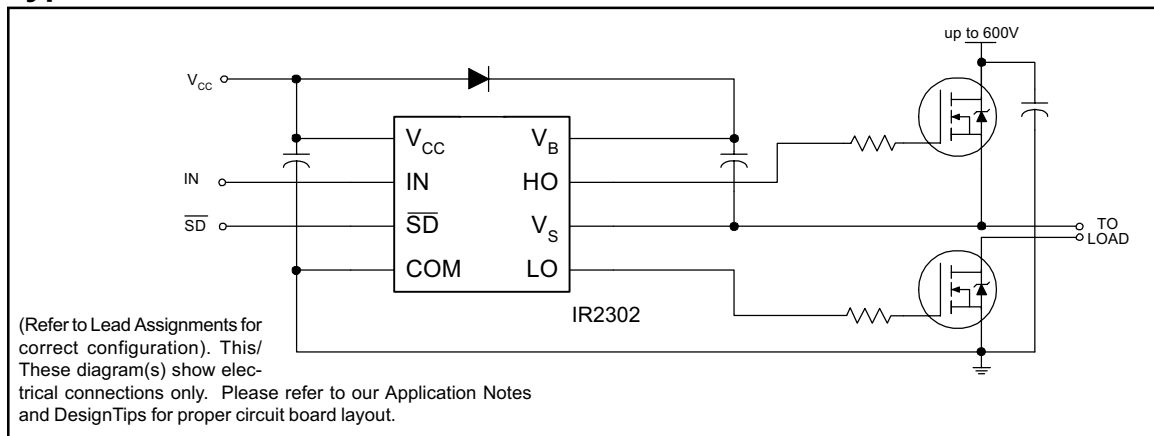

## Packages

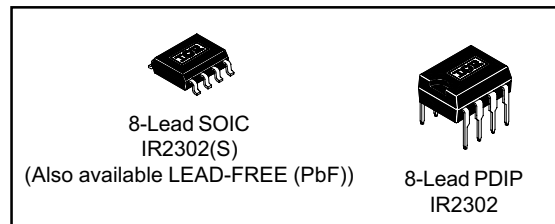

## 2106/2301//2108//2109/2302/2304 Feature Comparison

Part	Input logic	Cross-conduction prevention logic	Dead-Time	Ground Pins
2106/2301	HIN/LIN	no	none	COM
21064				VSS/COM
2108	HIN/LIN	yes	Internal 540ns Programmable 0.54~5µs	COM
21084				VSS/COM
2109/2302	IN/SD	yes	Internal 540ns Programmable 0.54~5µs	COM
21094				VSS/COM
2304	HIN/LIN	yes	Internal 100ns	COM

# IR2302(s) & (PbF)

## Absolute Maximum Ratings

Absolute maximum ratings indicate sustained limits beyond which damage to the device may occur. All voltage parameters are absolute voltages referenced to COM. The thermal resistance and power dissipation ratings are measured under board mounted and still air conditions.

Symbol	Definition	Min.	Max.	Units
V <sub>B</sub>	High side floating absolute voltage	-0.3	625	V
V <sub>S</sub>	High side floating supply offset voltage	V <sub>B</sub> - 25	V <sub>B</sub> + 0.3	
V <sub>HO</sub>	High side floating output voltage	V <sub>S</sub> - 0.3	V <sub>B</sub> + 0.3	
V <sub>CC</sub>	Low side and logic fixed supply voltage	-0.3	25	
V <sub>LO</sub>	Low side output voltage	-0.3	V <sub>CC</sub> + 0.3	
V <sub>IN</sub>	Logic input voltage (IN & $\overline{SD}$ )	COM - 0.3	V <sub>CC</sub> + 0.3	
dV <sub>S</sub> /dt	Allowable offset supply voltage transient	—	50	V/ns
P <sub>D</sub>	Package power dissipation @ T <sub>A</sub> ≤ +25°C (8 Lead PDIP) (8 Lead SOIC)	—	1.0	W
		—	0.625	
R <sub>thJA</sub>	Thermal resistance, junction to ambient (8 Lead PDIP) (8 Lead SOIC)	—	125	°C/W
		—	200	
T <sub>J</sub>	Junction temperature	—	150	°C
T <sub>S</sub>	Storage temperature	-50	150	
T <sub>L</sub>	Lead temperature (soldering, 10 seconds)	—	300	

## Recommended Operating Conditions

The input/output logic timing diagram is shown in figure 1. For proper operation the device should be used within the recommended conditions. The V<sub>S</sub> offset rating is tested with all supplies biased at 15V differential.

Symbol	Definition	Min.	Max.	Units
V <sub>B</sub>	High side floating supply absolute voltage	V <sub>S</sub> + 5	V <sub>S</sub> + 20	V
V <sub>S</sub>	High side floating supply offset voltage	Note 1	600	
V <sub>HO</sub>	High side floating output voltage	V <sub>S</sub>	V <sub>B</sub>	
V <sub>CC</sub>	Low side and logic fixed supply voltage	5	20	
V <sub>LO</sub>	Low side output voltage	0	V <sub>CC</sub>	
V <sub>IN</sub>	Logic input voltage (IN & $\overline{SD}$ )	COM	V <sub>CC</sub>	
T <sub>A</sub>	Ambient temperature	-40	150	°C

Note 1: Logic operational for V<sub>S</sub> of -5V to +600V. Logic state held for V<sub>S</sub> of -5V to -V<sub>BS</sub>. (Please refer to the Design Tip DT97-3 for more details).

### Dynamic Electrical Characteristics

$V_{BIAS} (V_{CC}, V_{BS}) = 15V$ ,  $C_L = 1000 \text{ pF}$ , and  $T_A = 25^\circ\text{C}$  unless otherwise specified.

Symbol	Definition	Min.	Typ.	Max.	Units	Test Conditions
$t_{on}$	Turn-on propagation delay	550	750	950	nsec	$V_S = 0V$
$t_{off}$	Turn-off propagation delay	—	200	280		$V_S = 0V$ or $600V$
$t_{sd}$	Shut-down propagation delay	—	200	280		
MT	Delay matching, HS & LS turn-on/off	—	0	50		
$t_r$	Turn-on rise time	—	130	220		$V_S = 0V$
$t_f$	Turn-off fall time	—	50	80		$V_S = 0V$
DT	Deadtime: LO turn-off to HO turn-on( $DT_{LO-HO}$ ) & HO turn-off to LO turn-on( $DT_{HO-LO}$ )	400	540	680		
MDT	Deadtime matching = $DT_{LO-HO} - DT_{HO-LO}$	—	0	60		

### Static Electrical Characteristics

$V_{BIAS} (V_{CC}, V_{BS}) = 15V$  and  $T_A = 25^\circ\text{C}$  unless otherwise specified. The  $V_{IL}$ ,  $V_{IH}$  and  $I_{IN}$  parameters are referenced to COM and are applicable to the respective input leads: IN and  $\overline{SD}$ . The  $V_O$ ,  $I_O$  and  $R_{on}$  parameters are referenced to COM and are applicable to the respective output leads: HO and LO.

Symbol	Definition	Min.	Typ.	Max.	Units	Test Conditions
$V_{IH}$	Logic "1" input voltage for HO & logic "0" for LO	2.9	—	—	V	$V_{CC} = 10V$ to $20V$
$V_{IL}$	Logic "0" input voltage for HO & logic "1" for LO	—	—	0.8		$V_{CC} = 10V$ to $20V$
$V_{SD,TH+}$	$\overline{SD}$ input positive going threshold	2.9	—	—		$V_{CC} = 10V$ to $20V$
$V_{SD,TH-}$	$\overline{SD}$ input negative going threshold	—	—	0.8		$V_{CC} = 10V$ to $20V$
$V_{OH}$	High level output voltage, $V_{BIAS} - V_O$	—	0.8	1.4		$I_O = 20 \text{ mA}$
$V_{OL}$	Low level output voltage, $V_O$	—	0.3	0.6		$I_O = 20 \text{ mA}$
$I_{LK}$	Offset supply leakage current	—	—	50	$\mu\text{A}$	$V_B = V_S = 600V$
$I_{QBS}$	Quiescent $V_{BS}$ supply current	20	60	100	$\mu\text{A}$	$V_{IN} = 0V$ or $5V$
$I_{QCC}$	Quiescent $V_{CC}$ supply current	0.4	1.0	1.6	$\text{mA}$	$V_{IN} = 0V$ or $5V$
$I_{IN+}$	Logic "1" input bias current	—	5	20	$\mu\text{A}$	$IN = 5V, \overline{SD} = 0V$
$I_{IN-}$	Logic "0" input bias current	—	—	2	$\mu\text{A}$	$IN = 0V, \overline{SD} = 5V$
$V_{CCUV+}$ $V_{BSUV+}$	$V_{CC}$ and $V_{BS}$ supply undervoltage positive going threshold	3.3	4.1	5	V	
$V_{CCUV-}$ $V_{BSUV-}$	$V_{CC}$ and $V_{BS}$ supply undervoltage negative going threshold	3	3.8	4.7		
$V_{CCUVH}$ $V_{BSUVH}$	Hysteresis	0.1	0.3	—		
$I_{O+}$	Output high short circuit pulsed current	120	200	—	$\text{mA}$	$V_O = 0V, PW \leq 10 \mu\text{s}$
$I_{O-}$	Output low short circuit pulsed current	250	350	—		$V_O = 15V, PW \leq 10 \mu\text{s}$

# IR2302(s) & (PbF)

## Functional Block Diagrams

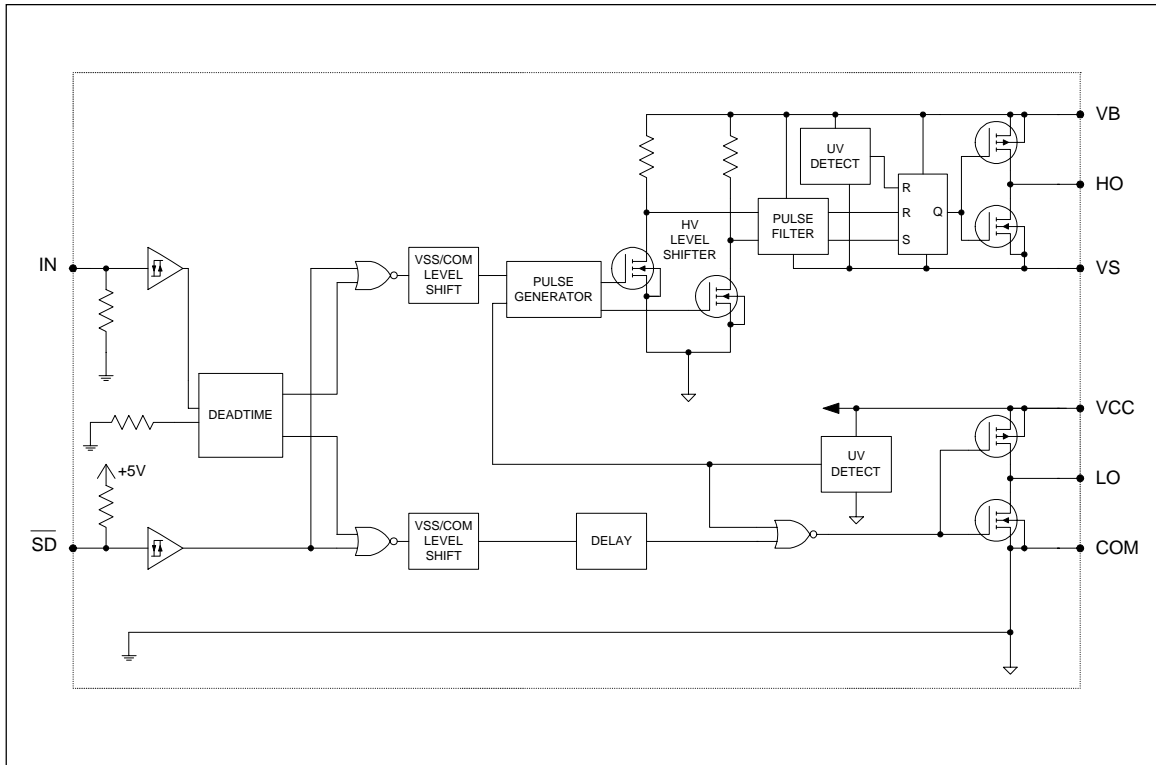

## IR2302(s) & (PbF)

### Lead Definitions

Symbol	Description
IN	Logic input for high and low side gate driver outputs (HO and LO), in phase with HO
$\overline{SD}$	Logic input for shutdown
$V_B$	High side floating supply
HO	High side gate drive output
$V_S$	High side floating supply return
$V_{CC}$	Low side and logic fixed supply
LO	Low side gate drive output
COM	Low side return

### Lead Assignments

<p>8 Lead PDIP</p>	<p>8 Lead SOIC (Also available LEAD-FREE (PbF))</p>
<b>IR2302</b>	<b>IR2302S</b>

# IR2302(s) & (PbF)

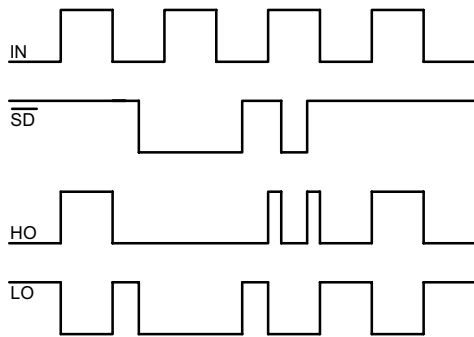

Figure 1. Input/Output Timing Diagram

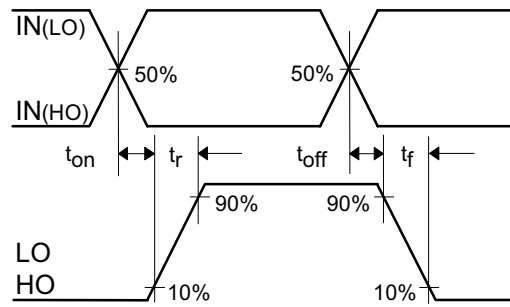

Figure 2. Switching Time Waveform Definitions

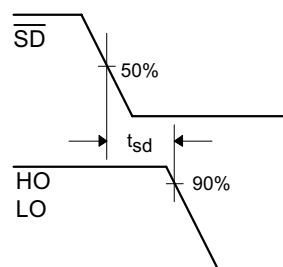

Figure 3. Shutdown Waveform Definitions

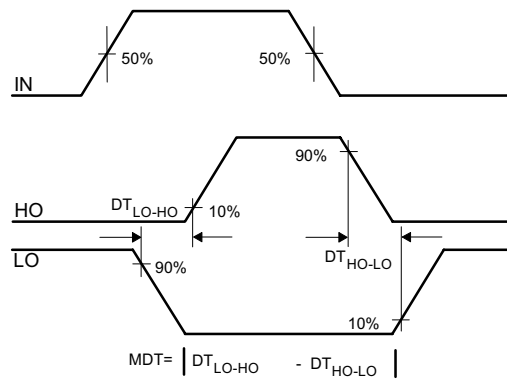

Figure 4. Deadtime Waveform Definitions

# IR2302(s) & (PbF)

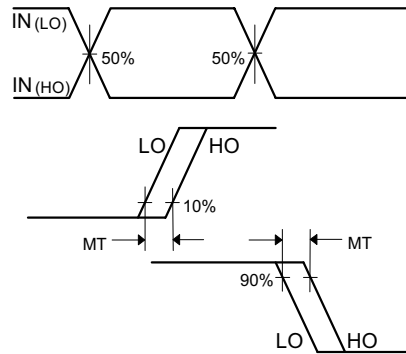

Figure 5. Delay Matching Waveform Definitions

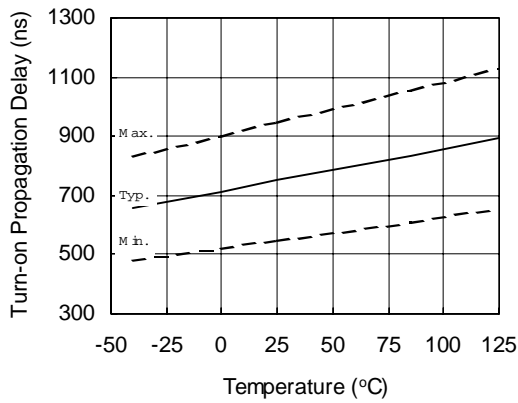

Figure 6A. Turn-on Propagation Delay vs. Temperature

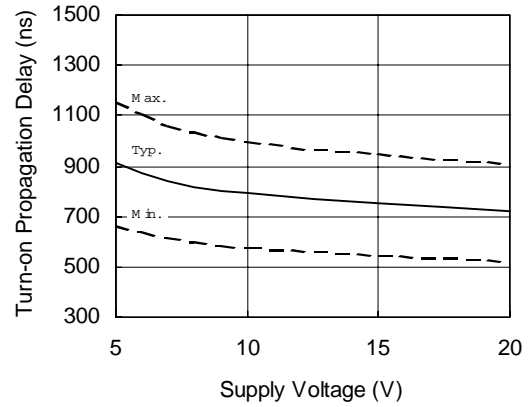

Figure 6B. Turn-on Propagation Delay vs. Supply Voltage

# IR2302(s) & (PbF)

International  
IR Rectifier

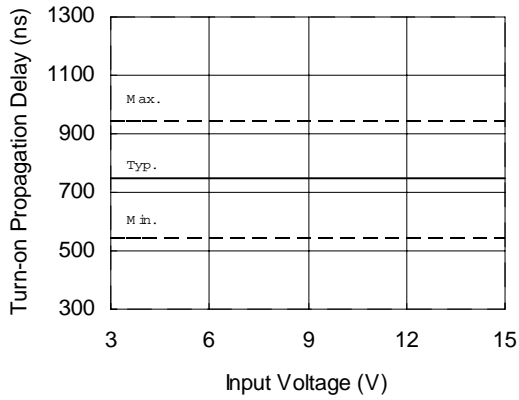

Figure 6C. Turn-on Propagation Delay vs. Input Voltage

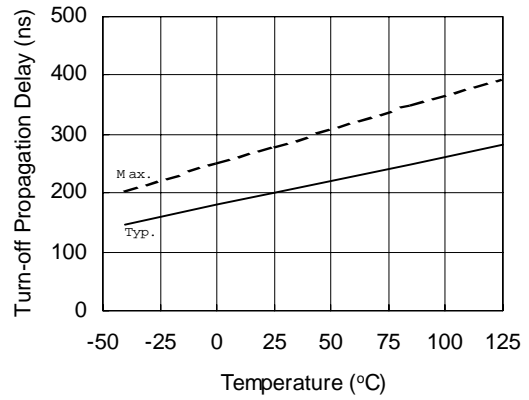

Figure 7A. Turn-off Propagation Delay vs. Temperature

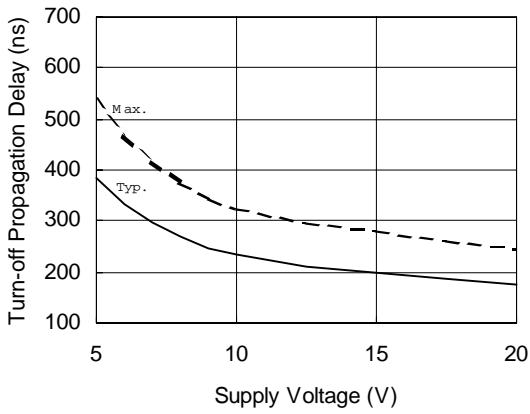

Figure 7B. Turn-off Propagation Delay vs. Supply Voltage

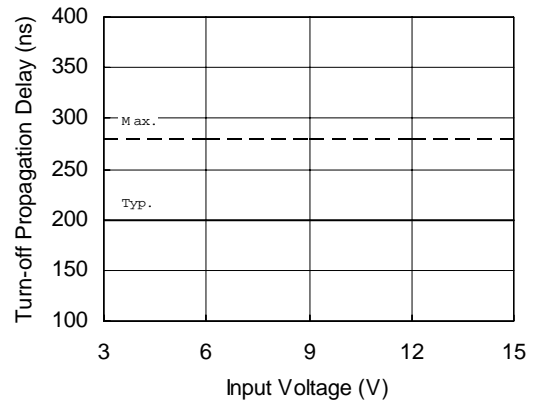

Figure 7C. Turn-off Propagation Delay vs. Input Voltage



# IR2302(s) & (PbF)

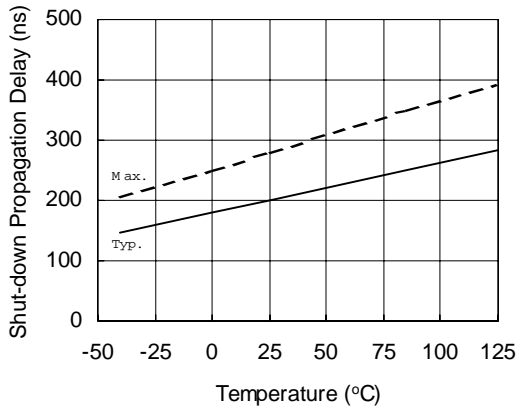

Figure 8A. Shut-down Propagation Delay vs. Temperature

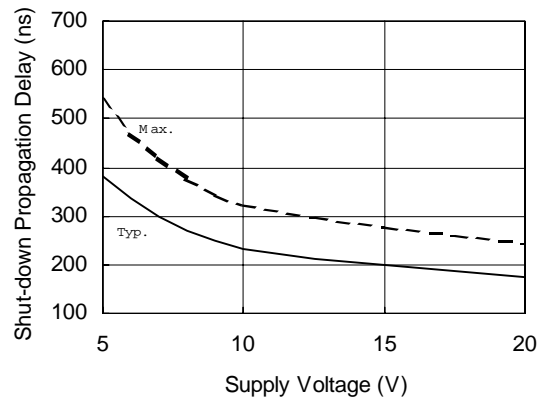

Figure 8B. Shut-down Propagation Delay vs. Supply Voltage

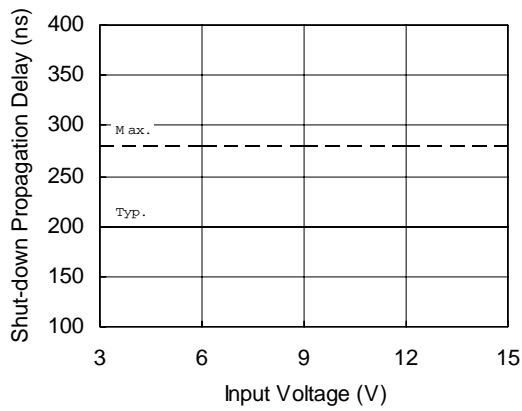

Figure 8C. Shut-down Propagation Delay vs. Input Voltage

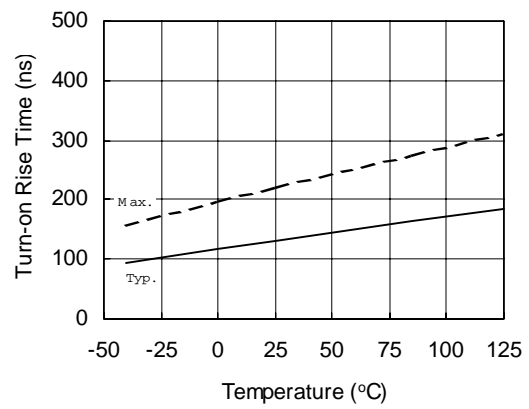

Figure 9A. Turn-on Rise Time vs. Temperature

# IR2302(s) & (PbF)

International  
IR Rectifier

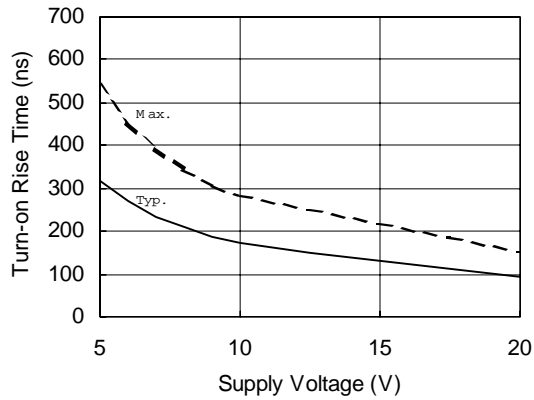

Figure 9B. Turn-on Rise Time vs. Supply Voltage

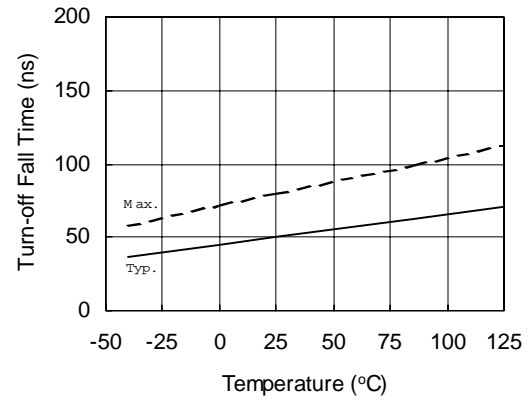

Figure 10A. Turn-off Fall Time vs. Temperature

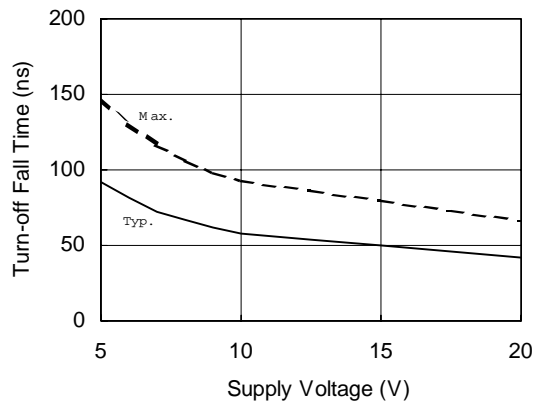

Figure 10B. Turn-off Fall Time vs. Supply Voltage

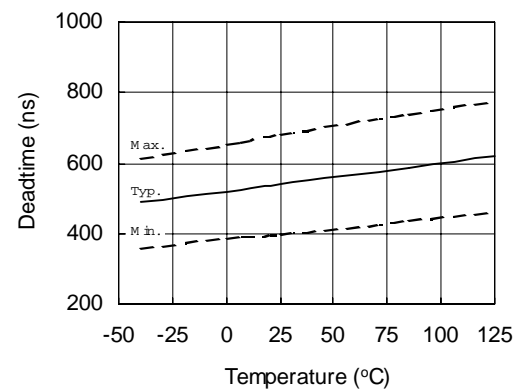

Figure 11A. Deadtime vs. Temperature

# IR2302(s) & (PbF)

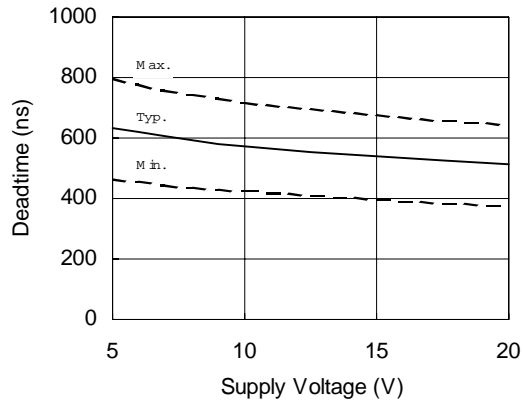

Figure 11B. Deadtime vs. Supply Voltage

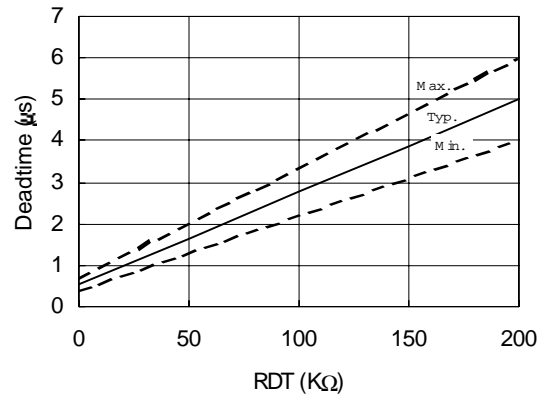

Figure 11C. Deadtime vs. RDT

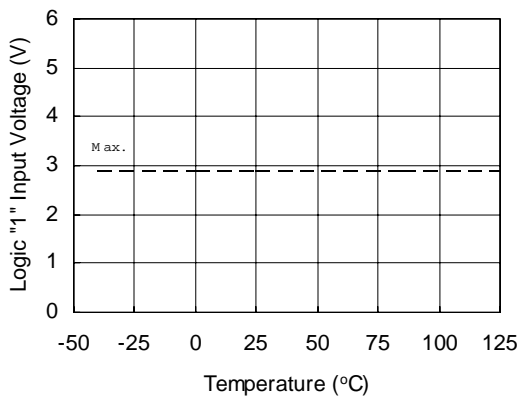

Figure 12A. Logic "1" Input Voltage vs. Temperature

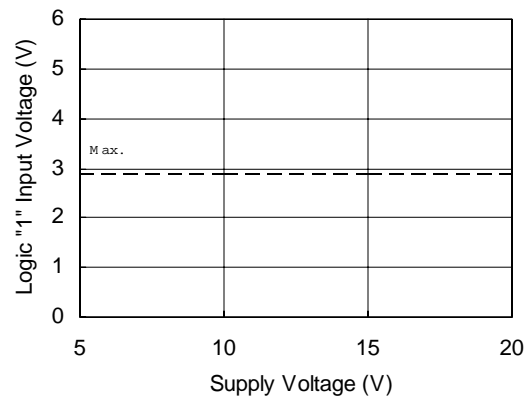

Figure 12B. Logic "1" Input Voltage vs. Supply Voltage

# IR2302(s) & (PbF)

International  
IR Rectifier

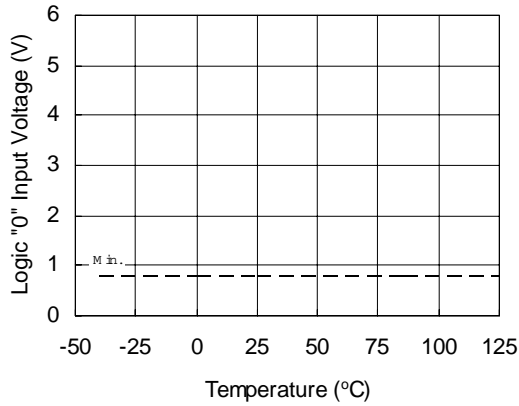

Figure 13A. Logic "0" Input Voltage vs. Temperature

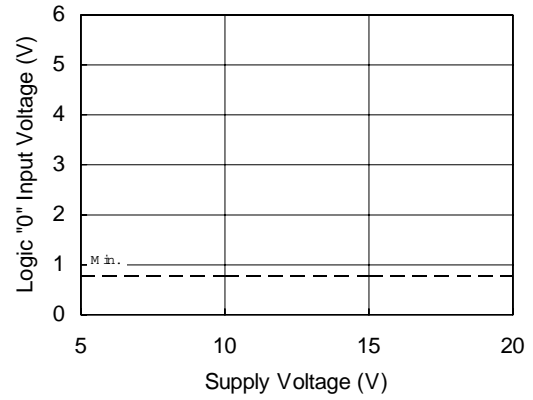

Figure 13B. Logic "0" Input Voltage vs. Supply Voltage

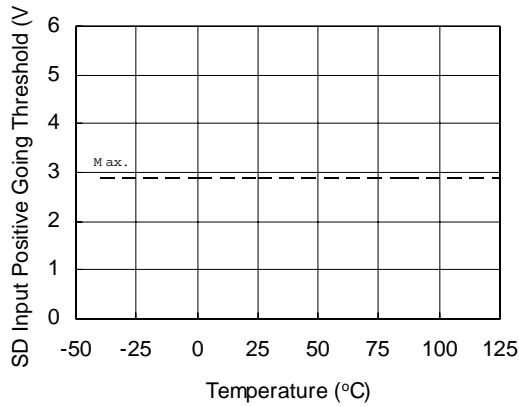

Figure 14A. SD Input Positive Going Threshold vs. Temperature

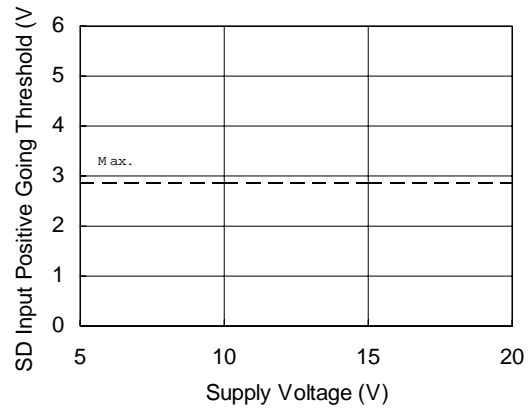

Figure 14B. SD Input Positive Going Threshold vs. Supply Voltage

# IR2302(s) & (PbF)

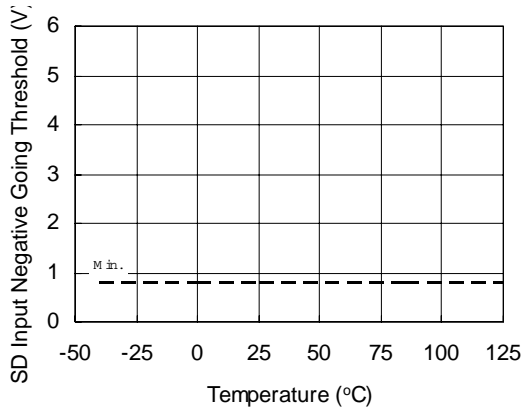

Figure 15A. SD Input Negative Going Threshold vs. Temperature

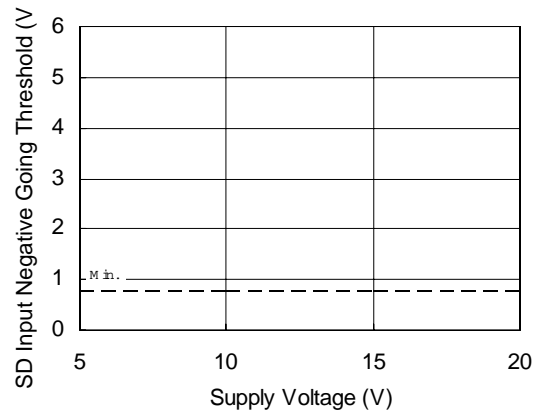

Figure 15B. SD Input Negative Going Threshold vs. Supply Voltage

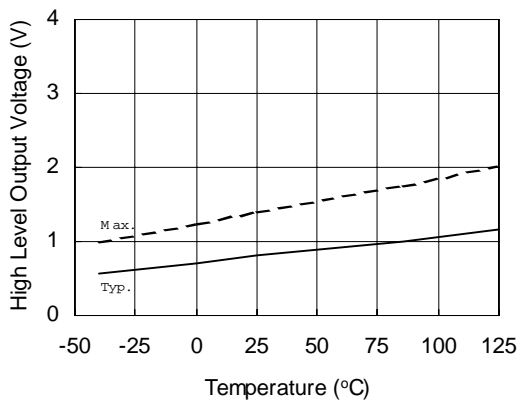

Figure 16A. High Level Output Voltage vs. Temperature

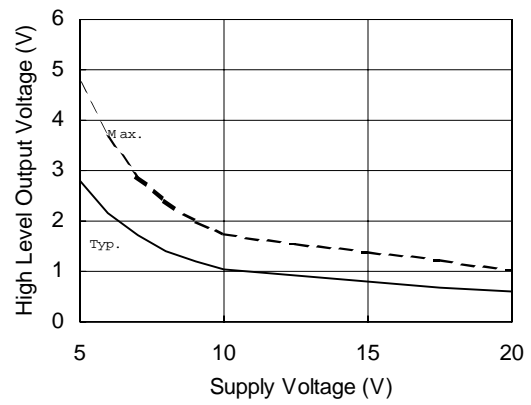

Figure 16B. High Level Output Voltage vs. Supply Voltage

# IR2302(s) & (PbF)

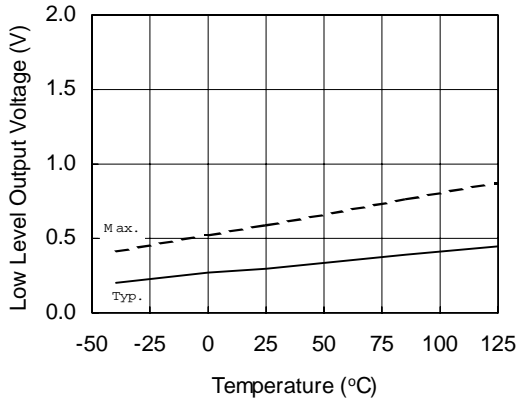

Figure 17A. Low Level Output Voltage vs. Temperature

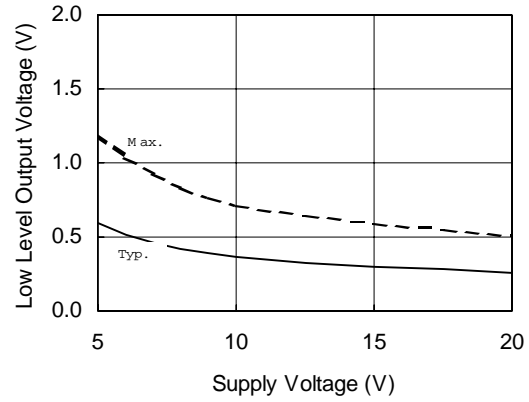

Figure 17B. Low Level Output Voltage vs. Supply Voltage

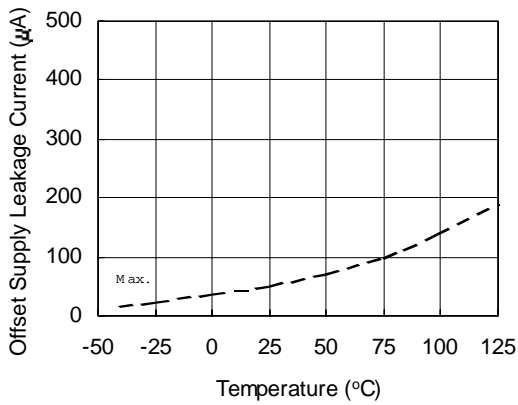

Figure 18A. Offset Supply Leakage Current vs. Temperature

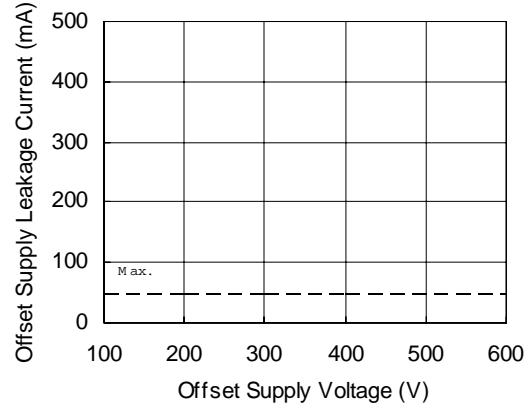

Figure 18B. Offset Supply Leakage Current vs. Offset Supply Voltage

# IR2302(s) & (PbF)

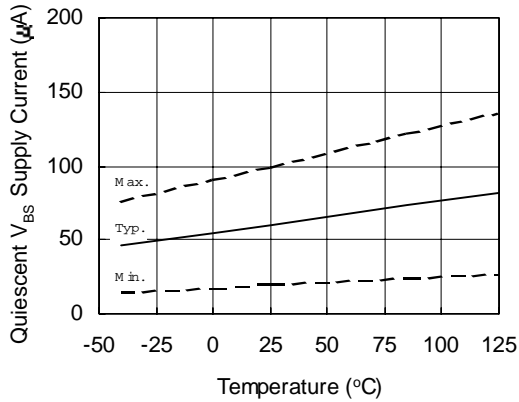

Figure 19A. Quiescent  $V_{BS}$  Supply Current vs. Temperature

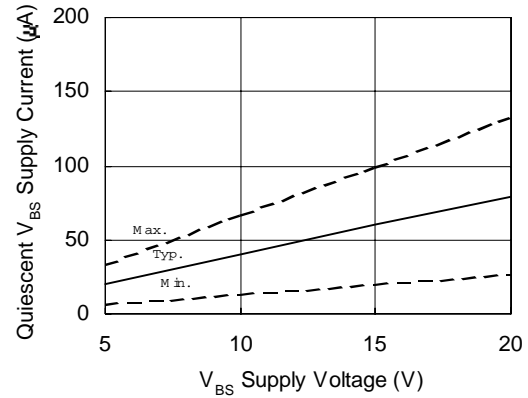

Figure 19B. Quiescent  $V_{BS}$  Supply Current vs.  $V_{BS}$  Supply Voltage

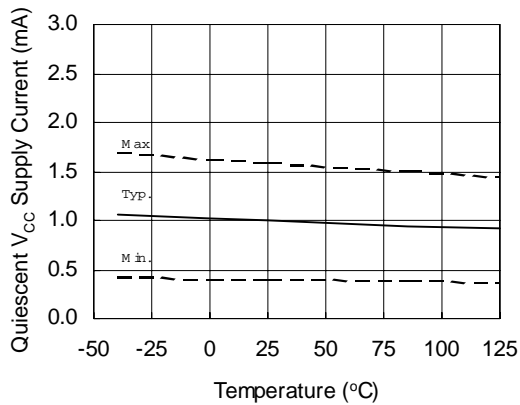

Figure 20A. Quiescent  $V_{CC}$  Supply Current vs. Temperature

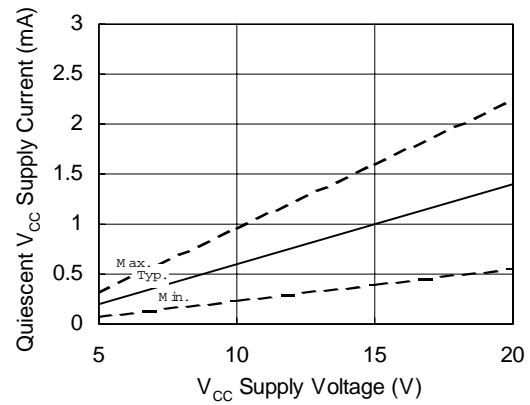

Figure 20B. Quiescent  $V_{CC}$  Supply Current vs.  $V_{CC}$  Supply Voltage

# IR2302(s) & (PbF)

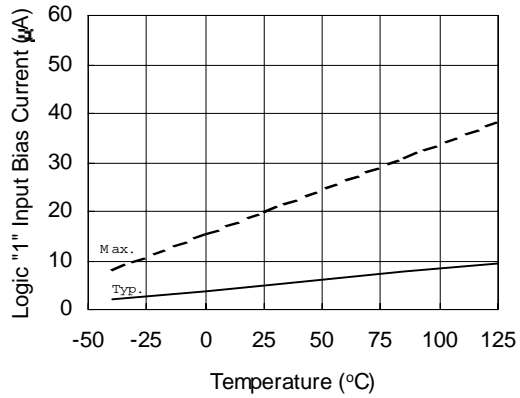

Figure 21A. Logic "1" Input Bias Current vs. Temperature

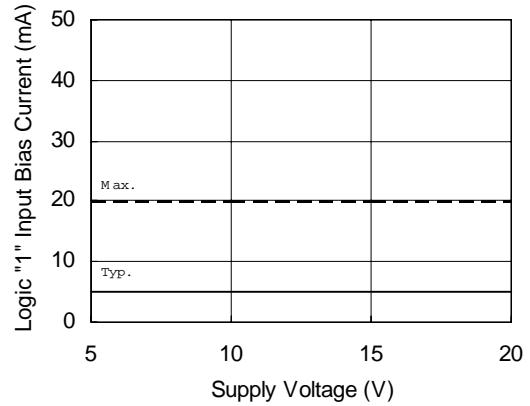

Figure 21B. Logic "1" Input Bias Current vs. Supply Voltage

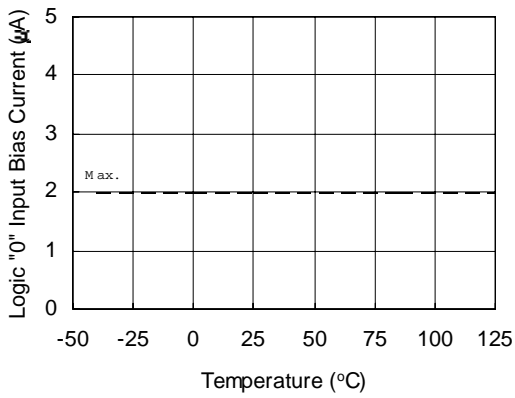

Figure 22A. Logic "0" Input Bias Current vs. Temperature

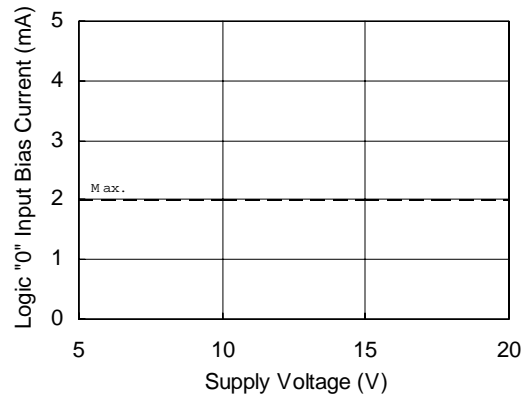

Figure 22B. Logic "0" Input Bias Current vs. Supply Voltage



# IR2302(s) & (PbF)

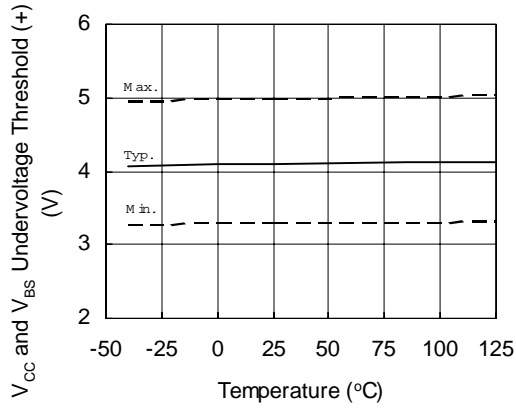

Figure 23. V<sub>CC</sub> and V<sub>BS</sub> Undervoltage Threshold (+) vs. Temperature

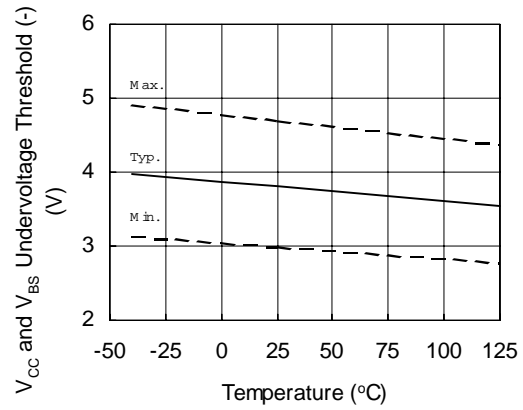

Figure 24. V<sub>CC</sub> and V<sub>BS</sub> Undervoltage Threshold (-) vs. Temperature

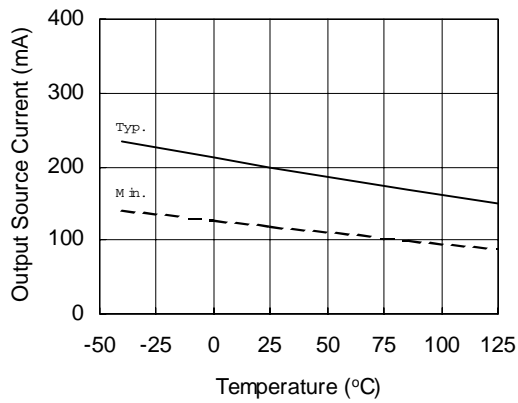

Figure 25A. Output Source Current vs. Temperature

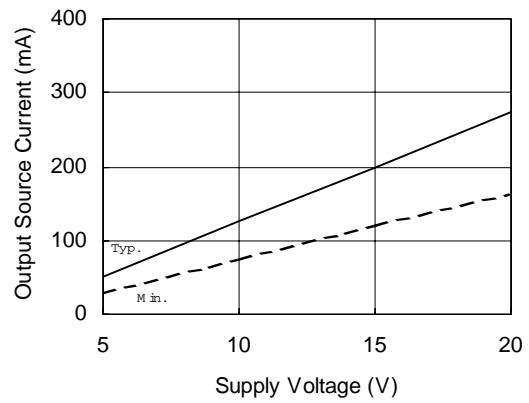

Figure 25B. Output Source Current vs. Supply Voltage

# IR2302(s) & (PbF)

International  
IR Rectifier

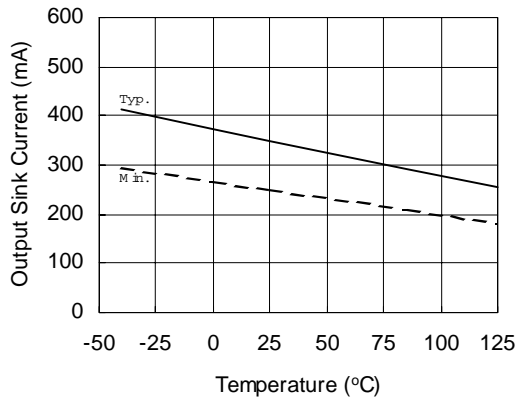

Figure 26A. Output Sink Current vs. Temperature

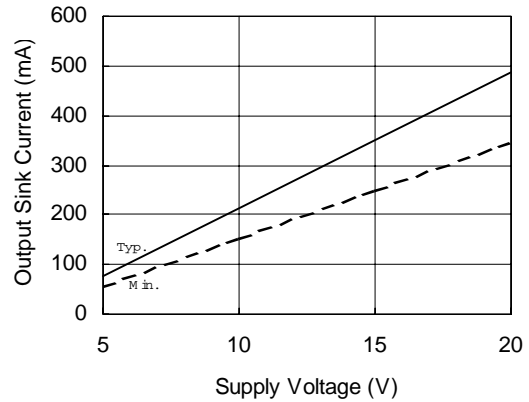

Figure 26B. Output Sink Current vs. Supply Voltage

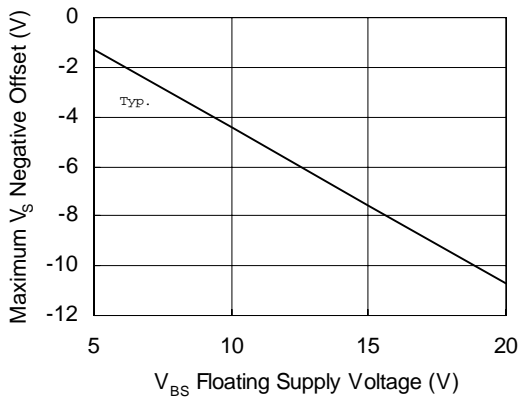

Figure 27. Maximum V<sub>s</sub> Negative Offset vs. V<sub>BS</sub> Floating Supply Voltage

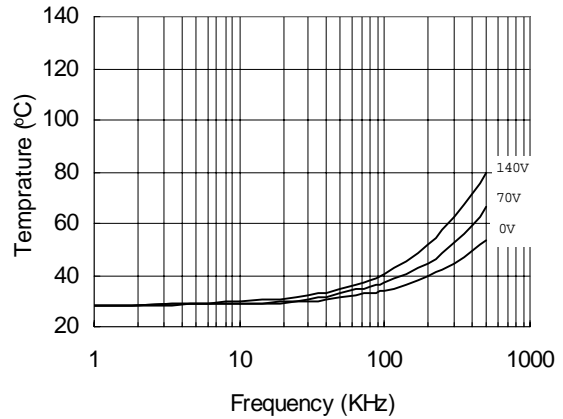

Figure 28. IR2302 vs. Frequency (IRFBC20),  
R<sub>gate</sub>=33Ω, V<sub>CC</sub>=15V

# IR2302(s) & (PbF)

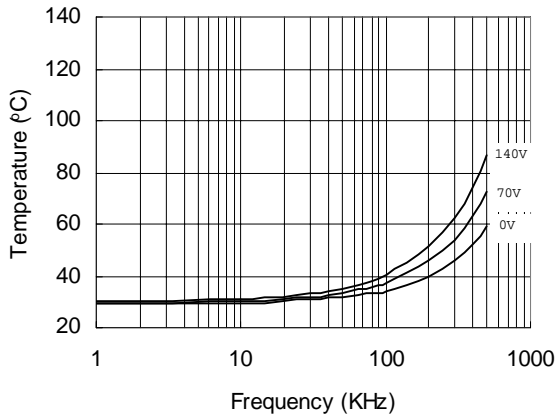

Figure 29. IR2302 vs. Frequency (IRFBC30),  
 $R_{gate}=22\Omega$ ,  $V_{CC}=15V$

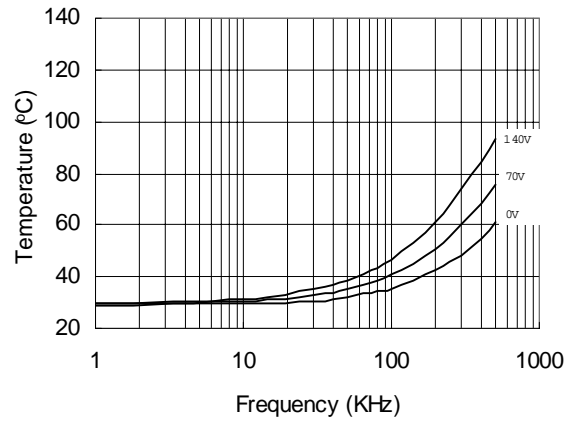

Figure 30. IR2302 vs. Frequency (IRFBC40),  
 $R_{gate}=15\Omega$ ,  $V_{CC}=15V$

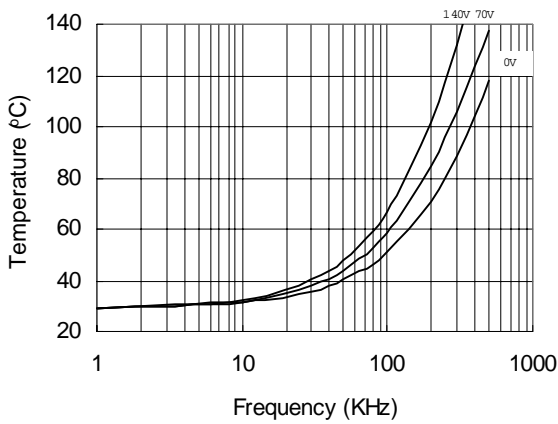

Figure 31. IR2302 vs. Frequency (IRFPE50),  
 $R_{gate}=10\Omega$ ,  $V_{CC}=15V$

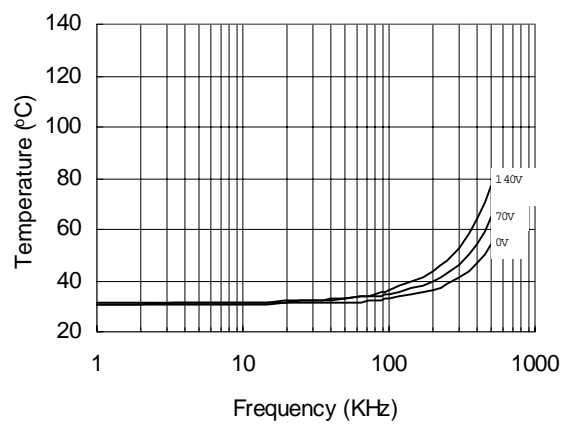

Figure 32. IR2302S vs. Frequency (IRFBC20),  
 $R_{gate}=33\Omega$ ,  $V_{CC}=15V$

# IR2302(s) & (PbF)

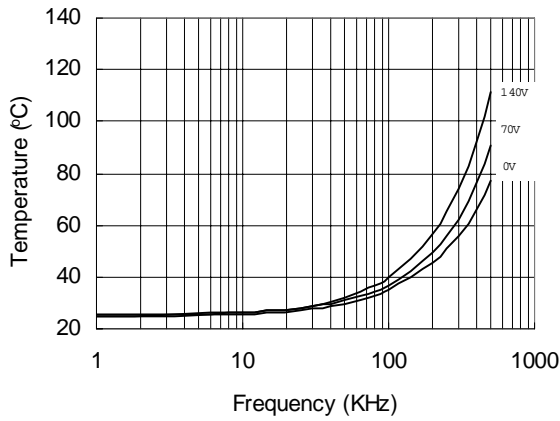

Figure 33. IR2302S vs. Frequency (IRFBC30),  
 $R_{gate}=22\Omega, V_{CC}=15V$

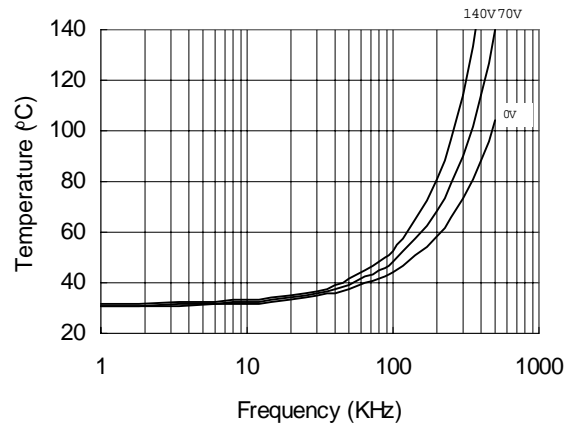

Figure 34. IR2302S vs. Frequency (IRFBC40),  
 $R_{gate}=15\Omega, V_{CC}=15V$

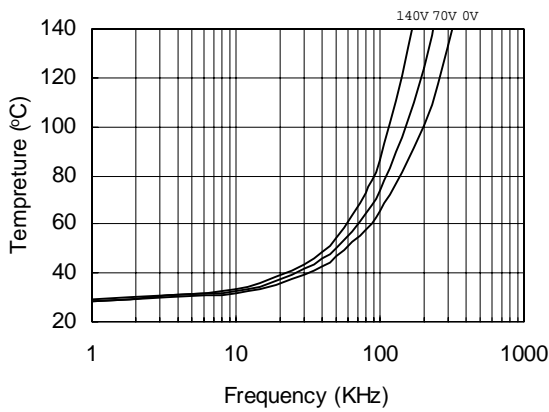
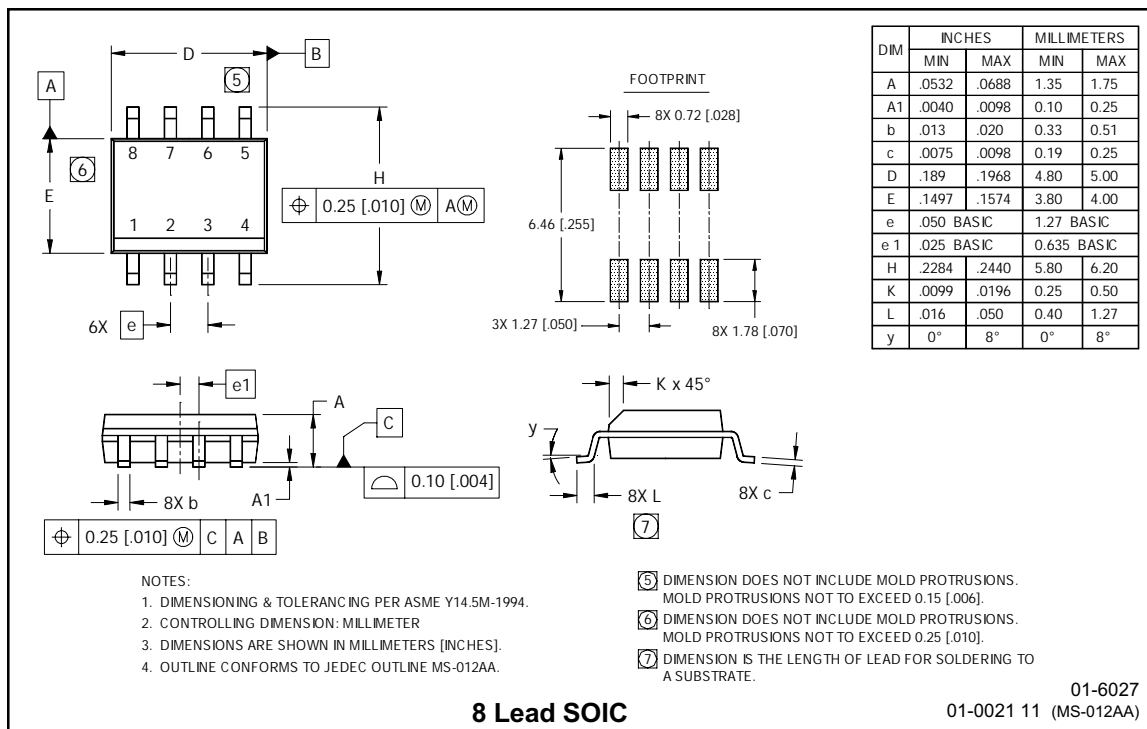
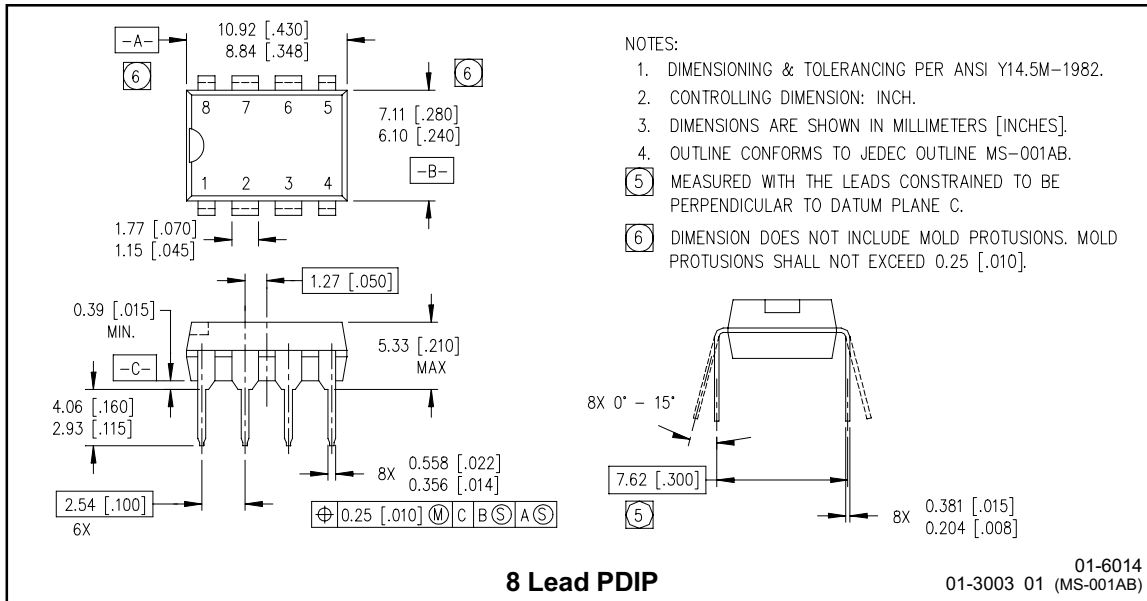

Figure 35. IR2302S vs. Frequency  
(IRFPE50),  $R_{gate}=10\Omega, V_{CC}=15V$

# IR2302(s) & (PbF)

## Case Outlines



# IR2302(s) & (PbF)

## LEADFREE PART MARKING INFORMATION

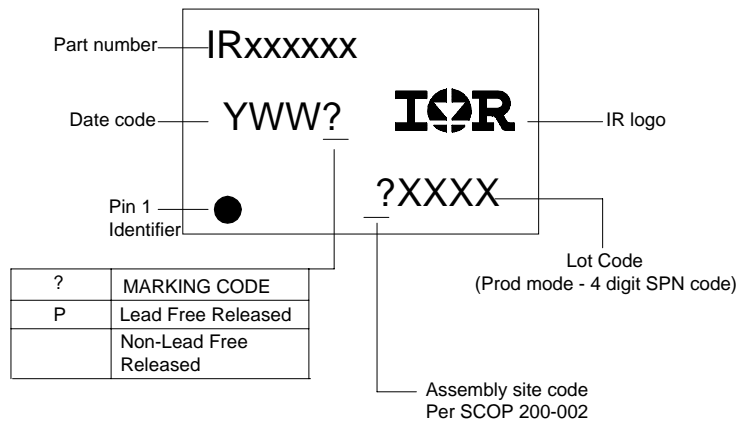

## ORDER INFORMATION

### Basic Part (Non-Lead Free)

8-Lead PDIP IR2302 order IR2302  
8-Lead SOIC IR2302S order IR2302S

### Leadfree Part

8-Lead PDIP R2302 not available  
8-Lead SOIC IR2302S order IR2302SPbF