

FRD Type : KCF16A60

OUTLINE DRAWING

FEATURES

- * Similar to TO-247AC (TO-3P) Case
- * Dual Diodes – Cathode Common
- * Ultra – Fast Recovery
- * Low Forward Voltage Drop
- * High Surge Capability
- * 200 Volts thru 600 Volts Types Available

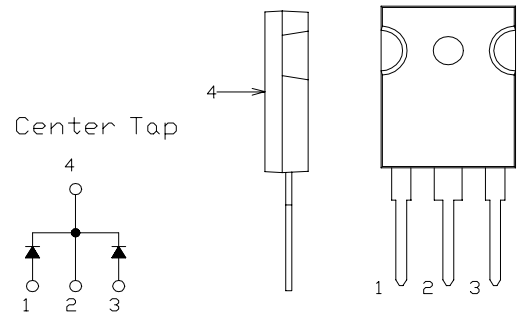

Maximum Ratings

Approx Net Weight:5.55g

Rating	Symbol	KCF16A60		Unit
Repetitive Peak Reverse Voltage	V_{RRM}	600		V
Average Rectified Output Current	I_O	16	$T_c=94^{\circ}C$ 50 Hz, Full Sine Wave Resistive Load	A
RMS Forward Current	$I_{F(RMS)}$	18		A
Surge Forward Current	I_{FSM}	120	50 Hz Full Sine Wave, 1 cycle Non-repetitive	A
Operating Junction Temperature Range	T_{jw}	- 40 to + 150		$^{\circ}C$
Storage Temperature Range	T_{stg}	- 40 to + 150		$^{\circ}C$
Mounting torque		0.5	Recommended value	N·m

Electrical • Thermal Characteristics

Characteristics	Symbol	Conditions	Min.	Typ.	Max.	Unit
Peak Reverse Current	I_{RM}	$T_j=25^{\circ}C, V_{RM}=V_{RRM}$ per Arm	-	-	30	μA
Peak Forward Voltage	V_{FM}	$T_j=25^{\circ}C, I_{FM}=8A$ per Arm	-	-	1.7	V
Reverse Recovery Time	t_{rr}	$I_{FM}= 8 A,$ $-di/dt= 50 A/\mu s, T_a= 25^{\circ}C$	-	-	50	ns
Thermal Resistance	$R_{th(j-c)}$	Junction to Case	-	-	2	$^{\circ}C/W$

KCF16A60 OUTLINE DRAWING (Dimensions in mm)

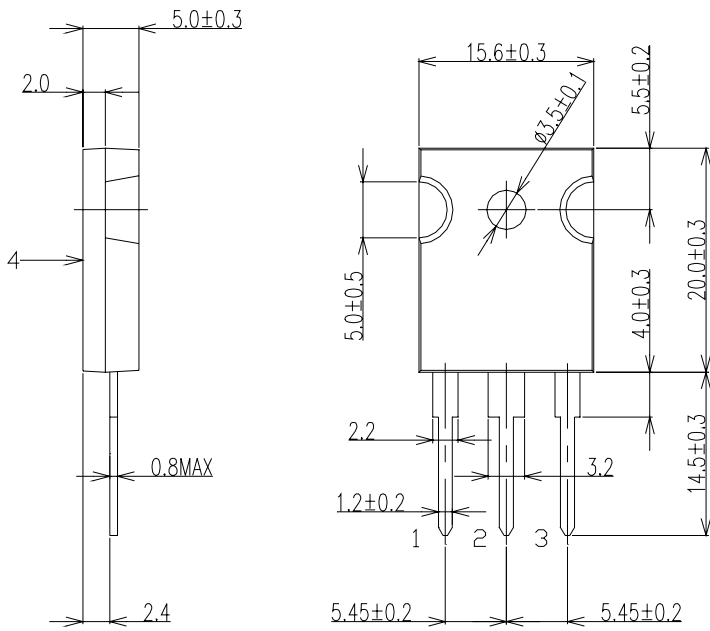

Center Tap

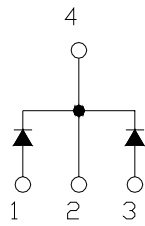

FORWARD CURRENT VS. VOLTAGE

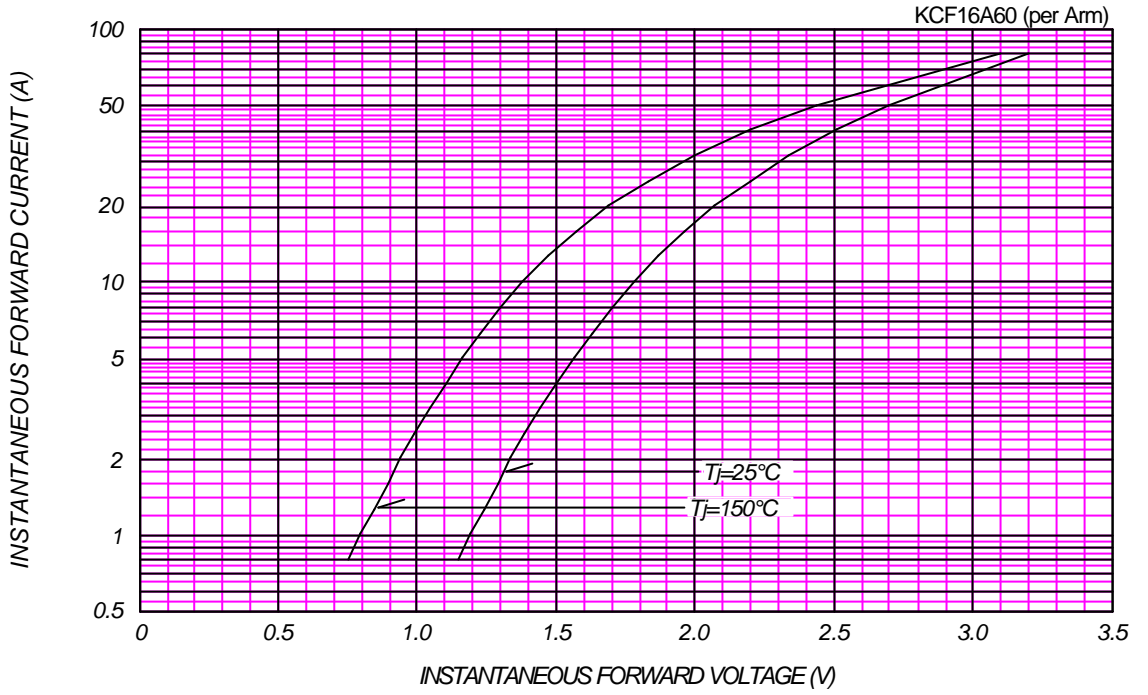

AVERAGE FORWARD POWER DISSIPATION

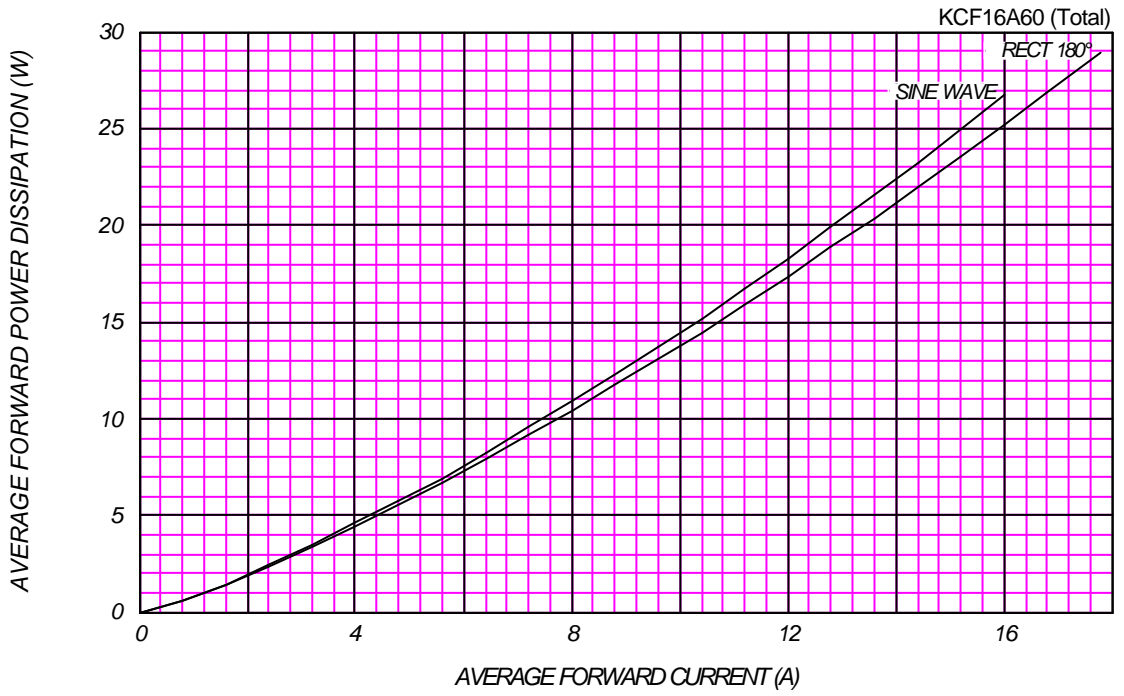

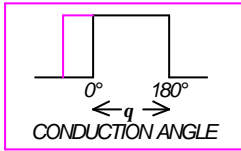

AVERAGE FORWARD CURRENT VS. CASE TEMPERATURE

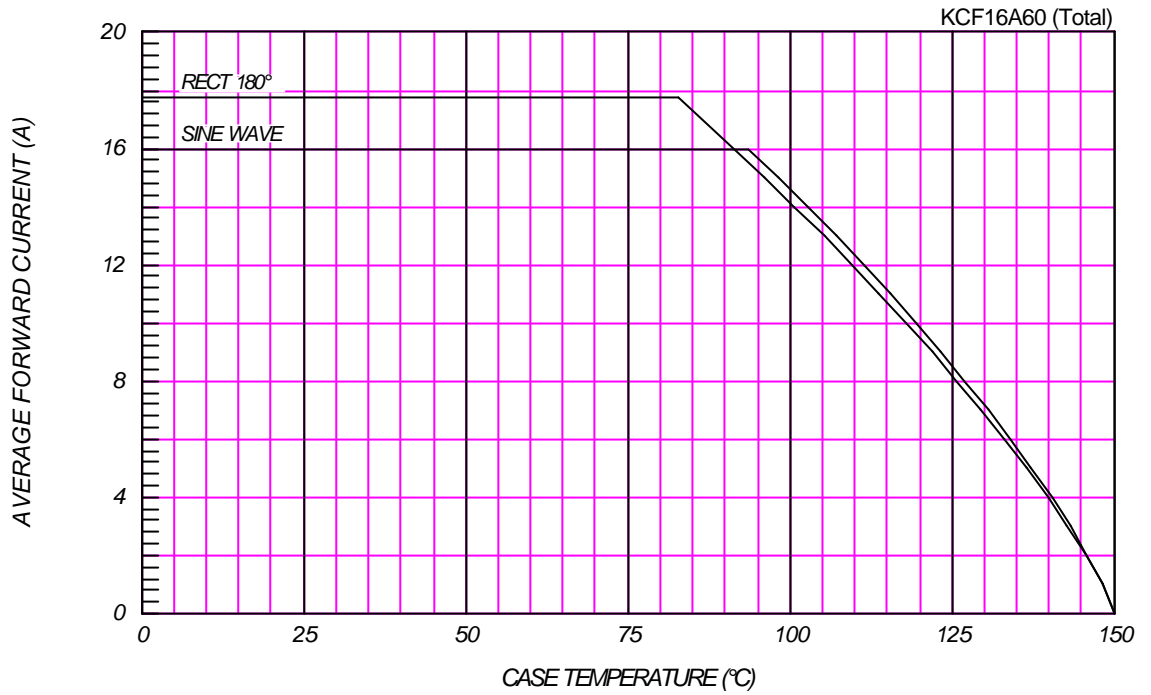

SURGE CURRENT RATINGS

f=50Hz, Sine Wave, Non-Repetitive, No Load

