



## LM324

## LINEAR INTEGRATED CIRCUIT

### QUAD OPERATIONAL AMPLIFIERS

#### DESCRIPTION

The UTC **LM324** consists of four independent, high gain internally frequency compensated operational amplifiers which are designed specifically to operated from a single power supply over a wide voltage range. Operation from split power supplies is also possible. Application areas include transducer amplifier, DC gain blocks and all the conventional OP amp circuits which now can be easily implemented in single power supply system.

#### FEATURES

- \*Internally frequency compensated for unity gain.
- \*Large DC voltage gain :100dB.
- \*Wide operating supply range (Vcc=3V~40V).
- \*Input common-mode voltage includes ground.
- \*Large output voltage swing: From 0V to Vcc-1.5V.
- \*Power drain suitable for battery operation.

#### ORDERING INFORMATION

Ordering Number			Package	Packing
Normal	Lead Free Plating	Halogen-Free		
LM324-D14-T	LM324L-D14-T	LM324G-D14-T	DIP-14	Tube
LM324-P14-R	LM324L-P14-R	LM324G-P14-R	TSSOP-14	Tape Reel
LM324-S14-R	LM324L-S14-R	LM324G-S14-R	SOP-14	Tape Reel

<p>LM324L-D14-T</p> <p>(1)Packing Type (2)Package Type (3)Lead Plating</p>	<p>(1) R: Tape Reel, T: Tube (2) D14: DIP-14, P14: TSSOP-14, S14: SOP-14 (3) G: Halogen Free, L: Lead Free Plating, Blank: Pb/Sn</p>
--	--

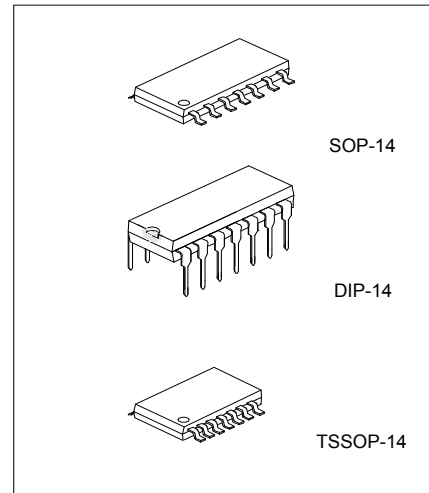

Lead-free: LM324L  
Halogen-free:LM324G

### ■ PIN DESCRIPTION

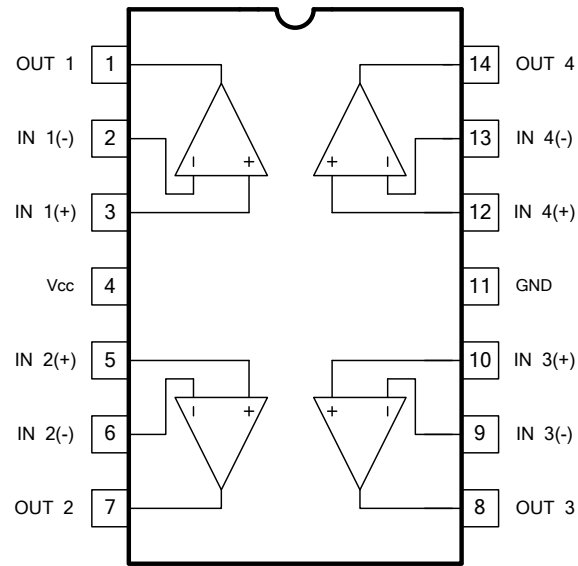

### ■ BLOCK DIAGRAM

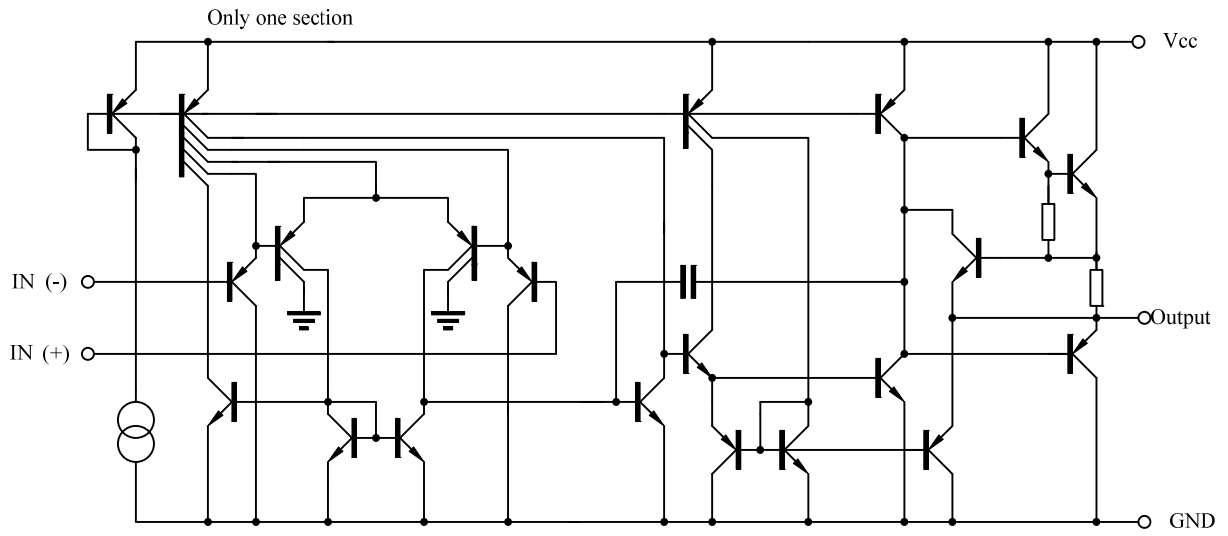

### ■ ABSOLUTE MAXIMUM RATINGS

PARAMETER	SYMBOL	RATINGS	UNIT
Supply Voltage	$V_{CC}$	$\pm 20$	V
Differential Input Voltage	$V_{I(DIFF)}$	40	V
Input Voltage	$V_{IN}$	-0.3 ~ +40	V
Power Dissipation	$P_D$	570	mW
Operating Temperature Range	$T_{OPR}$	-20 ~ +85	°C
Storage Temperature Range	$T_{STG}$	-40 ~ +150	°C

Note: Absolute maximum ratings are those values beyond which the device could be permanently damaged. Absolute maximum ratings are stress ratings only and functional device operation is not implied.

### ■ ELECTRICAL CHARACTERISTICS

( $V_{CC}=5.0V$ , All voltage referenced to GND unless otherwise specified.)

PARAMETER	SYMBOL	TEST CONDITIONS	MIN	TYP	MAX	UNIT
Input Offset Voltage	$V_{I(OFF)}$	$V_{CM}=0V$ to $V_{CC}-1.5V$ $V_{O(P)}=1.4V$ , $R_S=0\Omega$			7.0	mV
Input Offset Current	$I_{I(OFF)}$				50	nA
Input Bias Current	$I_{I(BIAS)}$				250	nA
Input Common Mode Voltage	$V_{I(CM)}$	$V_{CC}=30V$	0	$V_{CC}-1.5$		V
Power Supply Current	$I_{CC}$	$R_L=\infty$ , $V_{CC}=30V$		1.0	3.0	mA
		$V_{CC}=5V$		0.7	1.2	mA
Large Signal Voltage Gain	$G_V$	$V_{CC}=15V$ , $R_L \geq 2K\Omega$ $V_{O(P)}=1V \sim 11V$	25	100		V/mV
Output Voltage Swing	$V_{O(H)}$	$V_{CC}=30V$ , $R_L=2K\Omega$	26			V
		$V_{CC}=30V$ , $R_L=10K\Omega$	27	28		V
	$V_{O(L)}$	$V_{CC}=5V$ , $R_L > 10K\Omega$		5	20	mV
Common Mode Rejection Ratio	CMRR		65	75		dB
Power Supply Rejection Ratio	PSRR		65	100		dB
Channel Separation	CS	$f=1KHZ \sim 20KHZ$		120		dB
Short Circuit Current to Ground	$I_{SC}$			40	60	mA
Output Current	$I_{SOURCE}$	$V_{I(+)}=1V$ , $V_{I(-)}=0V$ $V_{CC}=15V$ , $V_{O(P)}=2V$	20	40		mA
	$I_{SINK}$	$V_{I(+)}=0V$ , $V_{I(-)}=1V$ $V_{CC}=15V$ , $V_{O(P)}=2V$	10	13		mA
		$V_{I(+)}=0V$ , $V_{I(-)}=1V$ $V_{CC}=15V$ , $V_{O(P)}=200mV$	12	45		mA
Differential Input Voltage	$V_{I(DIFF)}$				$V_{CC}$	V

## TYPICAL CHARACTERISTICS

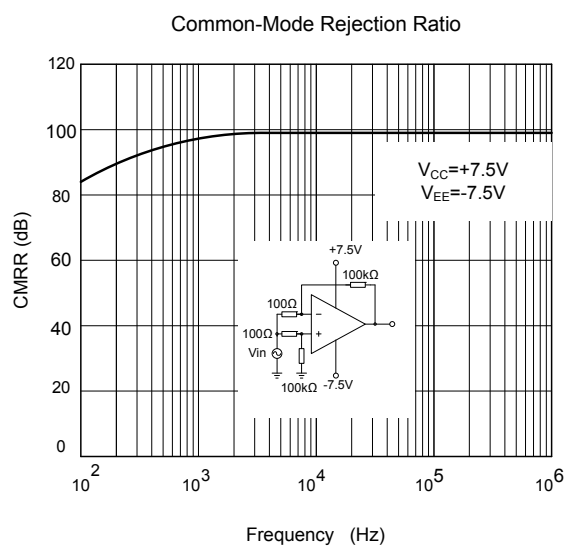
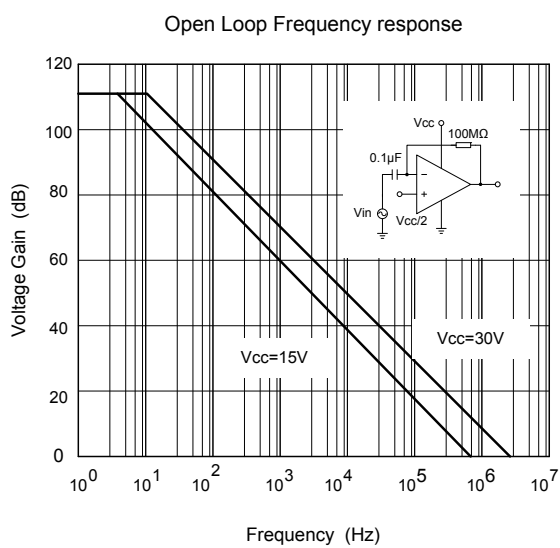
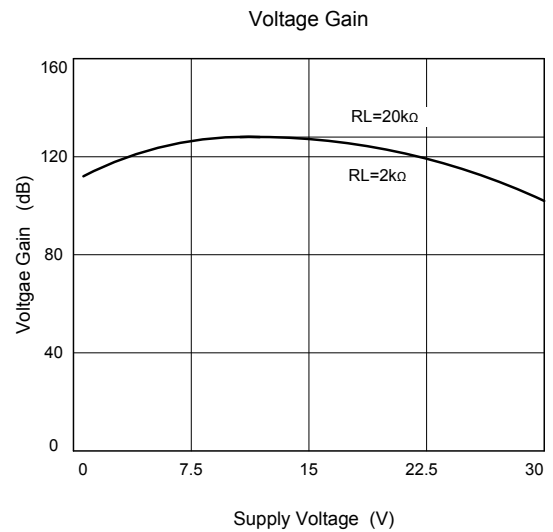
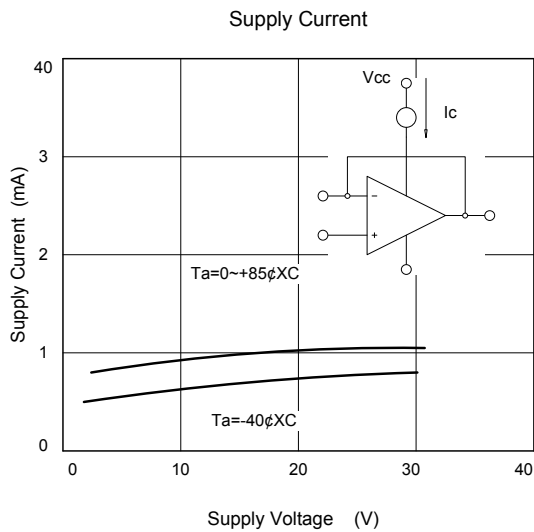
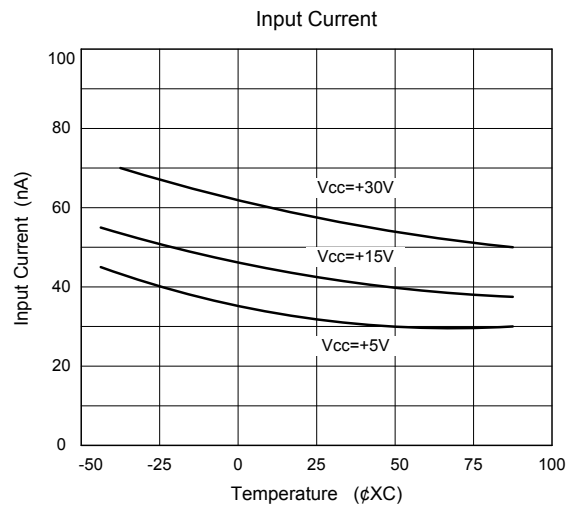
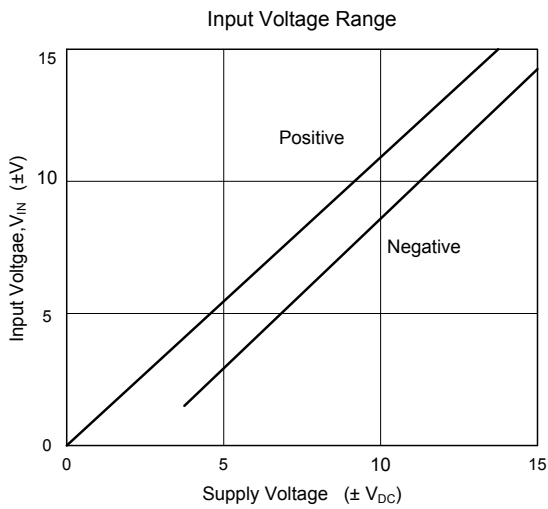

## TYPICAL CHARACTERISTICS(cont.)

Voltage Follower Pulse Response

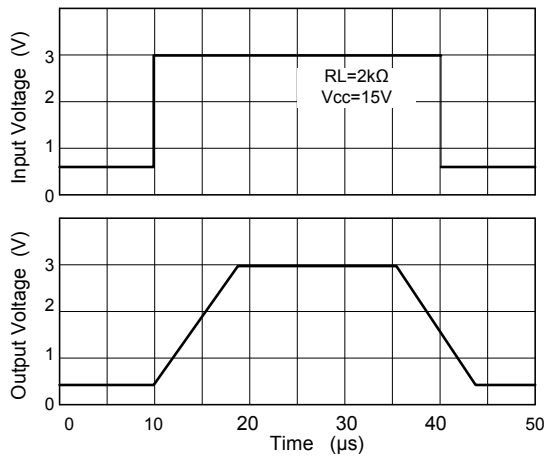

Voltage Follower pulse response (small signal)

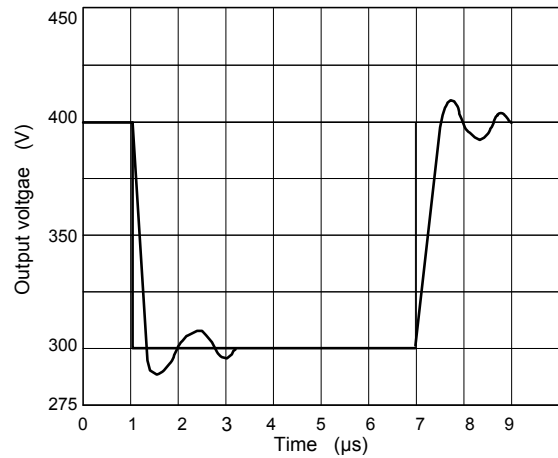

Large Signal Frequency Response

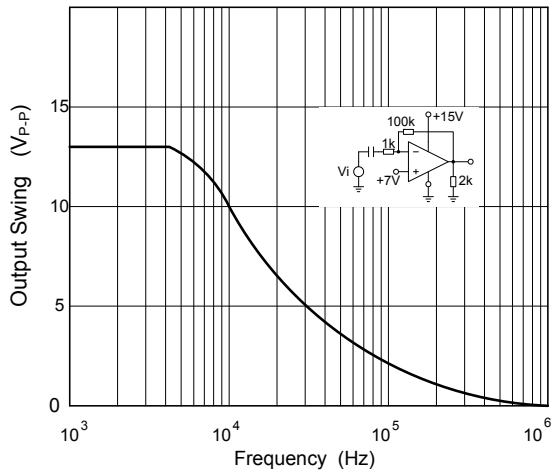

Output Characteristics Current Sourcing

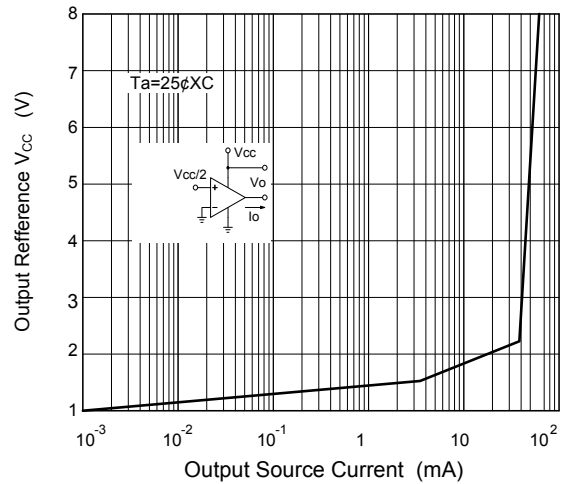

Large Signal Frequency Response

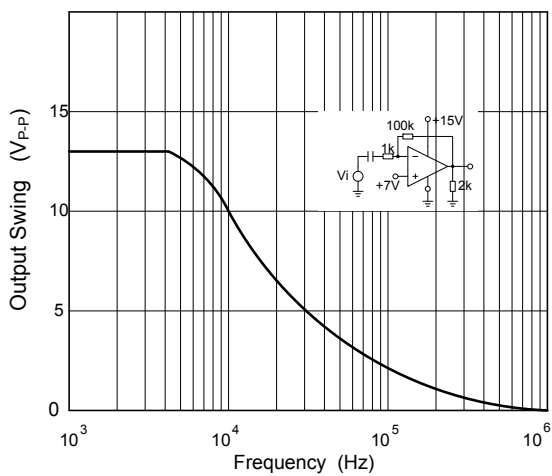

Output Characteristics Current Sourcing

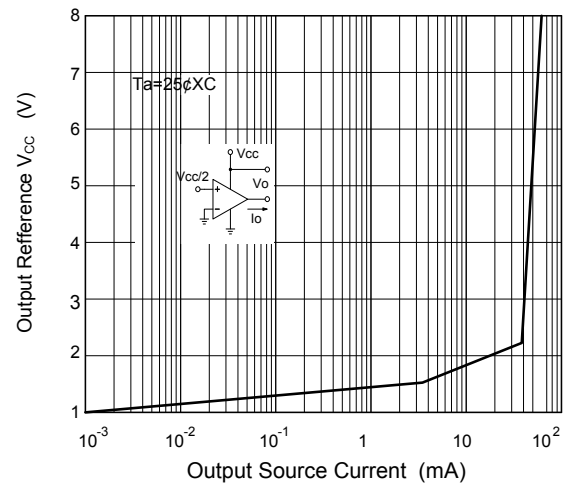

UTC assumes no responsibility for equipment failures that result from using products at values that exceed, even momentarily, rated values (such as maximum ratings, operating condition ranges, or other parameters) listed in products specifications of any and all UTC products described or contained herein. UTC products are not designed for use in life support appliances, devices or systems where malfunction of these products can be reasonably expected to result in personal injury. Reproduction in whole or in part is prohibited without the prior written consent of the copyright owner. The information presented in this document does not form part of any quotation or contract, is believed to be accurate and reliable and may be changed without notice.