



**Pb-free
HEAT**



U□38□4X Series

Single Color ϕ 3 Flush Mount Round Shape Type

Features

Package	3 Round shape type, UB,UC,UG : Water Clear epoxy UY : Pale Yellow Clear epoxy UR : Pale Red Clear epoxy
Product features	<ul style="list-style-type: none"> • Outer Dimension ϕ 3 Round shape type • Operation temperature range. Storage Temperature : -40 ~ 100 Operating Temperature : -40 ~ 85 • No lead package and lead-free soldering compatible
Dominant wavelength	Blue : 470nm (UB) Blue Green : 505nm (UC) Green : 525nm (UG) Yellow : 590nm (UY) Red : 626nm (UR)
Half Intensity Angle	UB,UC,UG : 56 deg. UY,UR : 66 deg.
Die materials	UB,UC,UG : InGaN, UY,UR : AlGaInP
Rank grouping parameter	Sorted by luminous intensity per rank taping
Soldering methods	TTW (Through The Wave) soldering and manual soldering
ESD	InGaN : Less than 1kV(HBM), AlGaInP : More than 2kV(HBM)
Packing	Bulk : 200pcs(MIN.)

Recommended Applications

Amusement Equipment, Electric Household Appliances, OA/FA, Other General Applications

Color and Luminous Intensity

(Ta=25°C)

Part No.	Material	Emitted Color	Lens Color		Dominant Wavelength λ d (nm)		Luminous Intensity Iv (mcd)		
					TYP.	I _F	MIN.	TYP.	I _F
					UB3804X	InGaN	Blue	Water Clear	Clear
UC3804X	InGaN	Blue Green	505	20	672	2,688	20		
UG3804X	InGaN	Green	525	20	960	2,688	20		
UY3864X	AlGaInP	Yellow	590	20	250	500	20		
UR3864X	AlGaInP	Red	630	20	220	440	20		

Absolute Maximum Ratings

(Ta=25°C)

Item	Symbol	Absolute Maximum Ratings					Unit
		UB	UC	UG	UY	UR	
Power Dissipation	P_d	105	105	105	150	150	mW
Forward Current	I_F	25	25	25	50	50	mA
Pulse Forward Current ※1	I_{FRM}	60	60	60	100	100	mA
Derating (Ta=25°C or higher)	I_F	0.33	0.33	0.33	0.67	0.67	mA/
Reverse Voltage	V_R	5	5	5	5	5	V
Operating Temperature	T_{opr}	-40~ +85					
Storage Temperature	T_{stg}	-40~ +100					

 ※1 I_{FRM} Measurement condition : Pulse Width ≤ 1 ms., Duty $\leq 1/20$.

Electro-Optical Characteristics

(Ta=25°C)

Item	Conditions	Symbol	Characteristics					Unit	
				UB	UC	UG	UY		UR
Forward Voltage	I _F =20mA	V _F	TYP.	3.7	3.7	3.7	2.2	2.2	V
			MAX.	4.2	4.2	4.2	2.8	2.8	
Reverse Current	V _R =5V	I _R	MAX.	100	100	100	100	100	μ A
Peak Wavelength	I _F =20mA	λ _p	TYP.	465	502	517	592	641	nm
Dominant Wavelength	I _F =20mA	λ _d	TYP.	470	505	525	590	630	nm
Spectral Line Half Width	I _F =20mA		TYP.	26	30	35	18	18	nm
Half Intensity Angle	I _F =20mA	2θ 1/2	TYP.	56	56	56	66	66	deg.

Luminous Intensity Rank

(Ta=25°C)

Rank	I _v (mcd)										Condition
	UB		UC		UG		UY		UR		
	MIN.	MAX.	MIN.	MAX.	MIN.	MAX.	MIN.	MAX.	MIN.	MAX.	
A	/		672	1,344	/		250	500	220	440	I _F = 20mA
B			960	1,920			350	700	300	600	
C	240	480	1,344	2,688	960	1,920	500	1,000	440	880	
D	336	672	1,920	3,840	1,344	2,688	700	1,400	600	1,200	
E	480	960	2,688	5,376	1,920	3,840	1,000	2,000	880	1,760	
F	672	1,344	3,840	-	2,688	5,376	1,400	-	1,200	-	
G	960	1,920	/		3,840	7,680	/		/		
H	1,344	-			5,376	-					

Please contact our sales staff concerning rank designation of UY and UR.

Technical Data(UB)

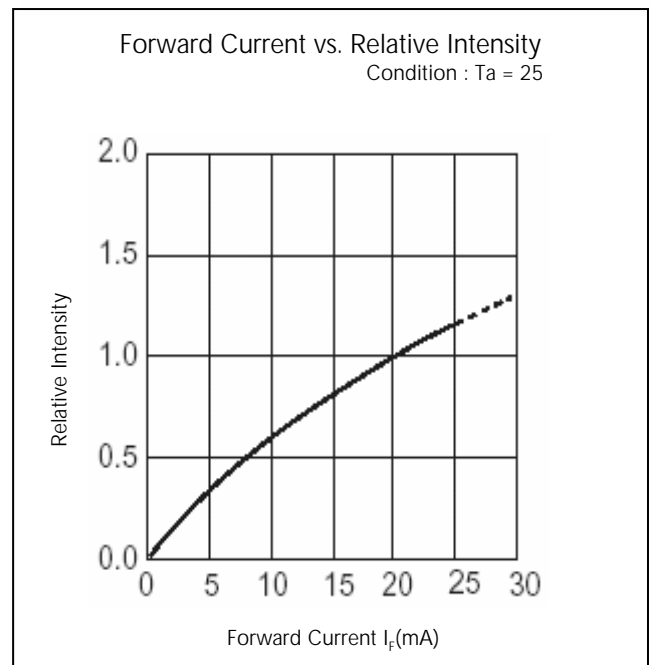
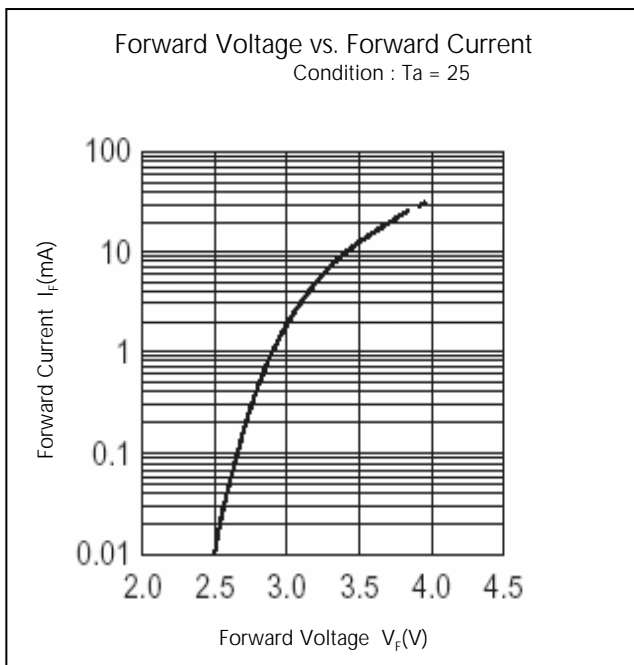
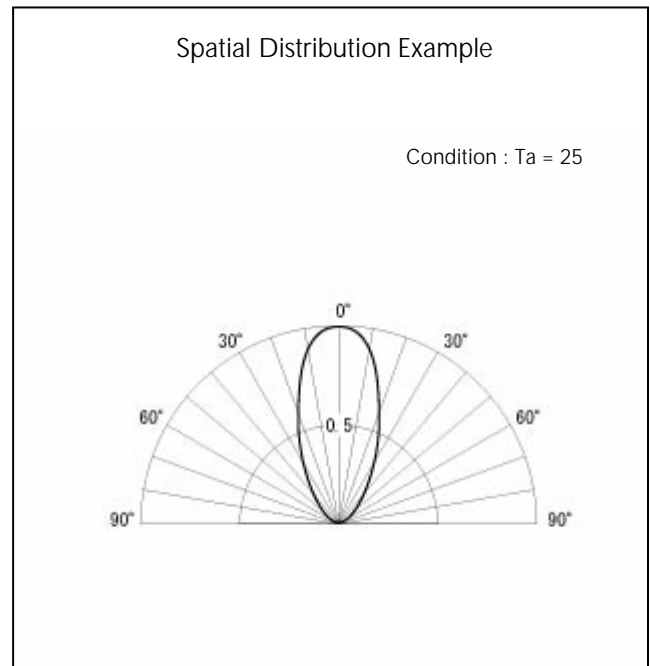
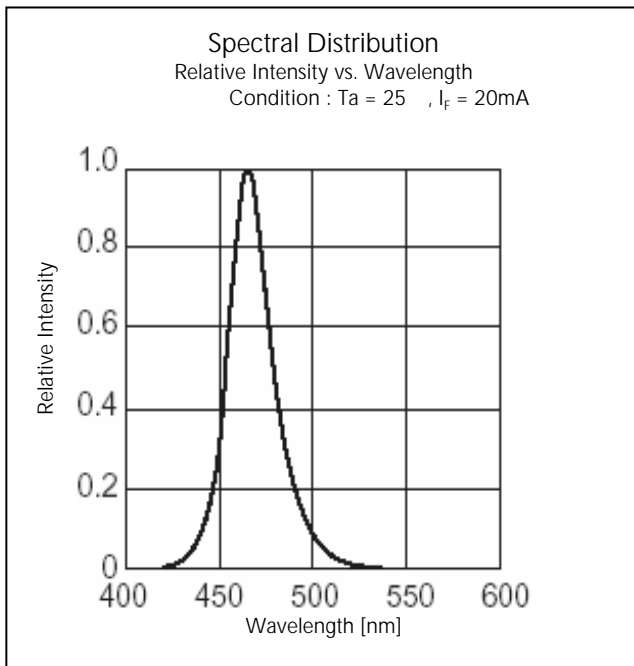

Technical Data(UB)

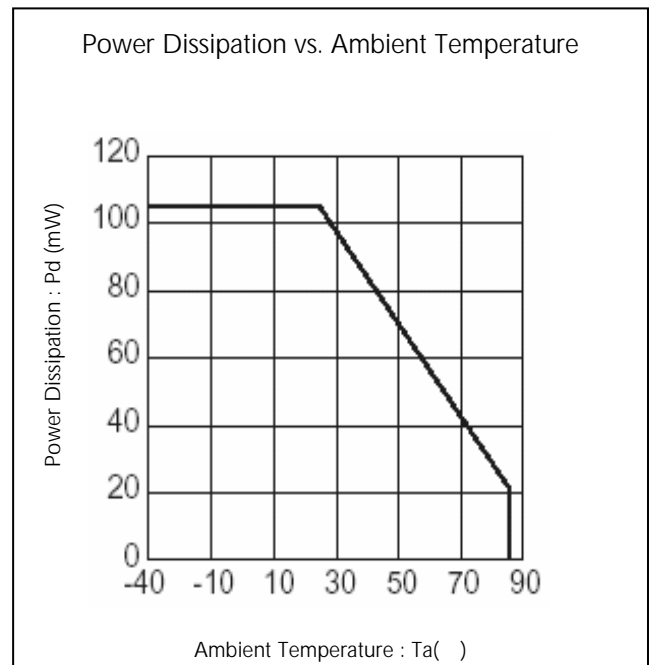
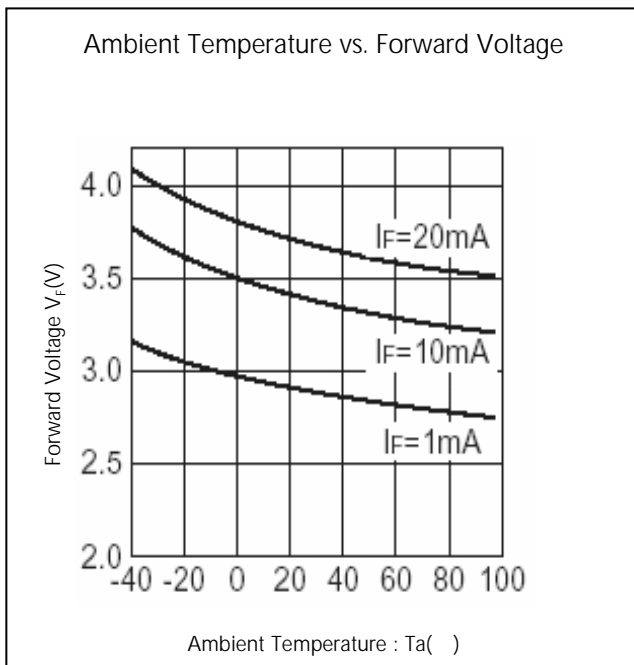
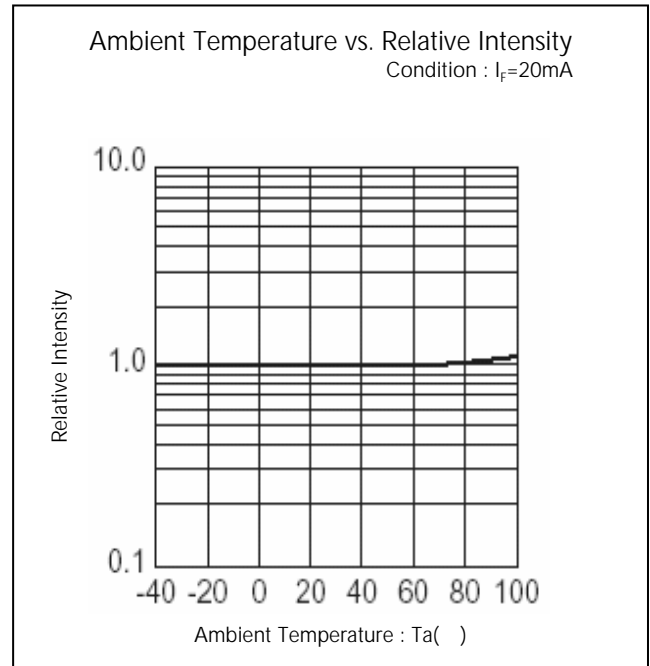
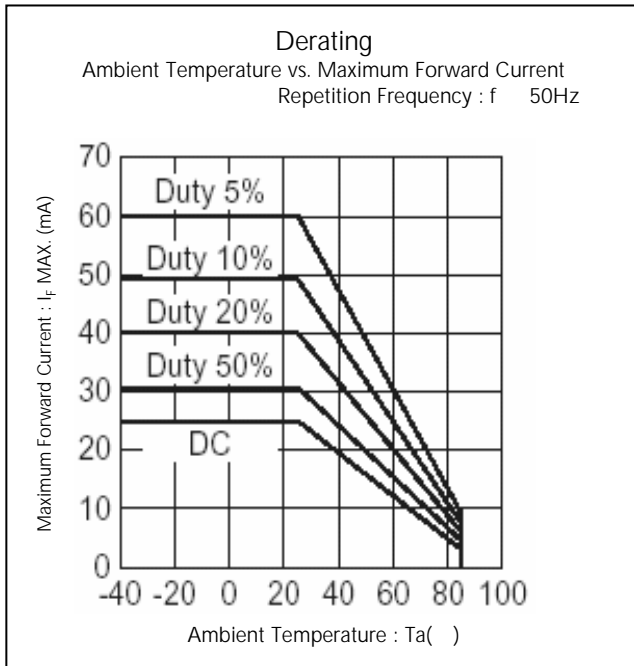

Technical Data(UB)

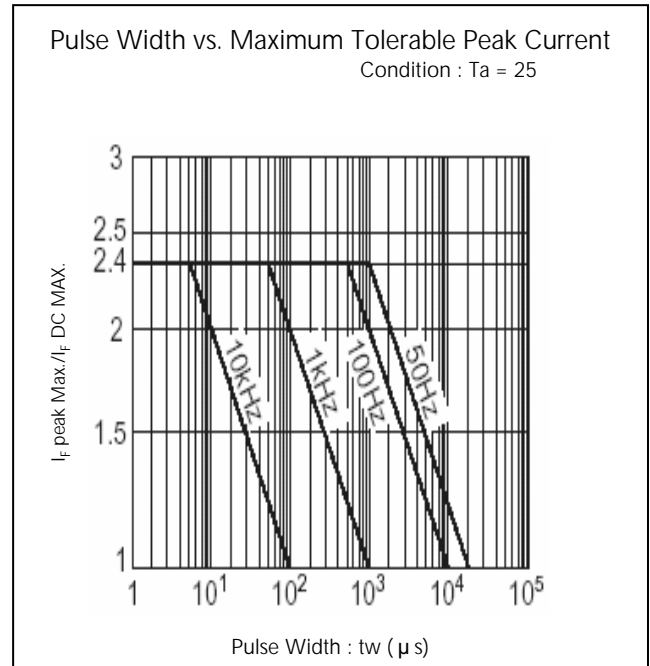
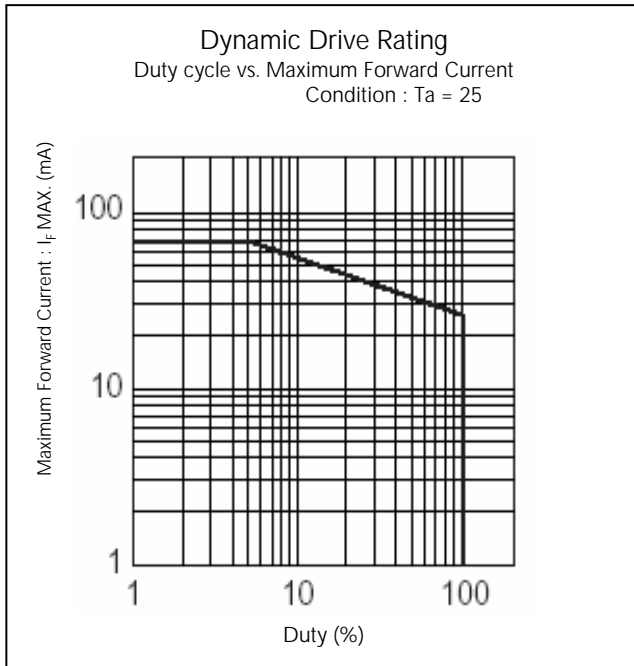

Technical Data(UC)

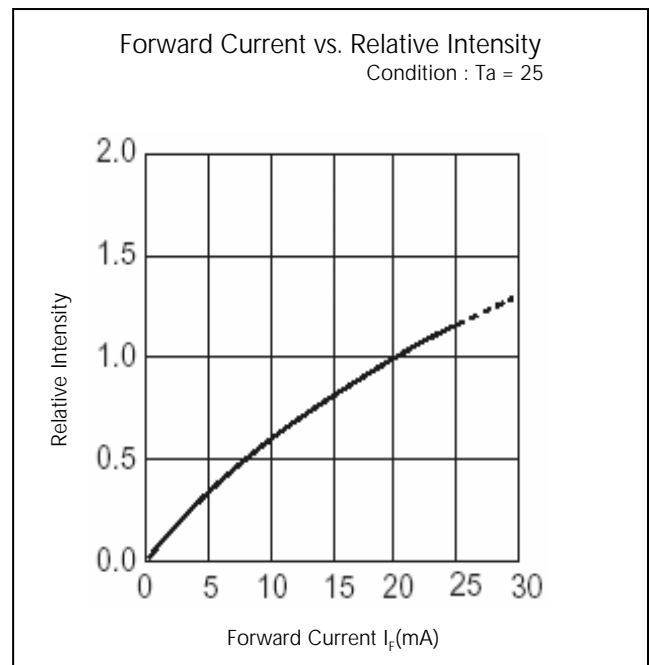
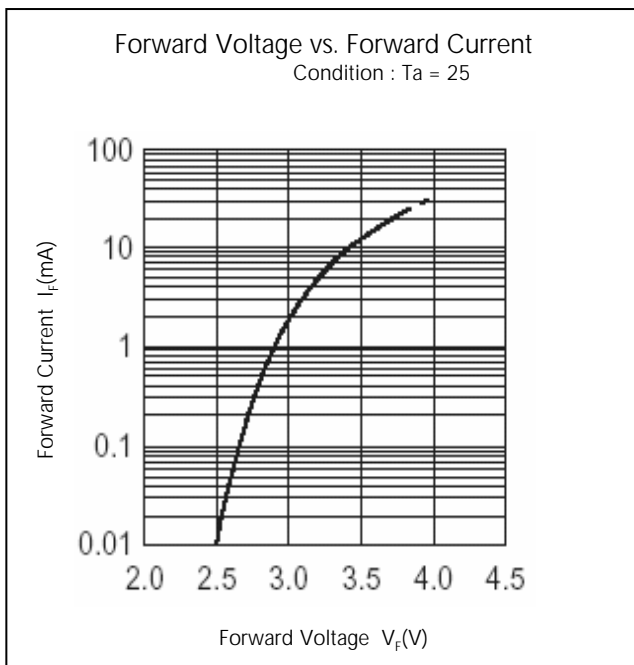
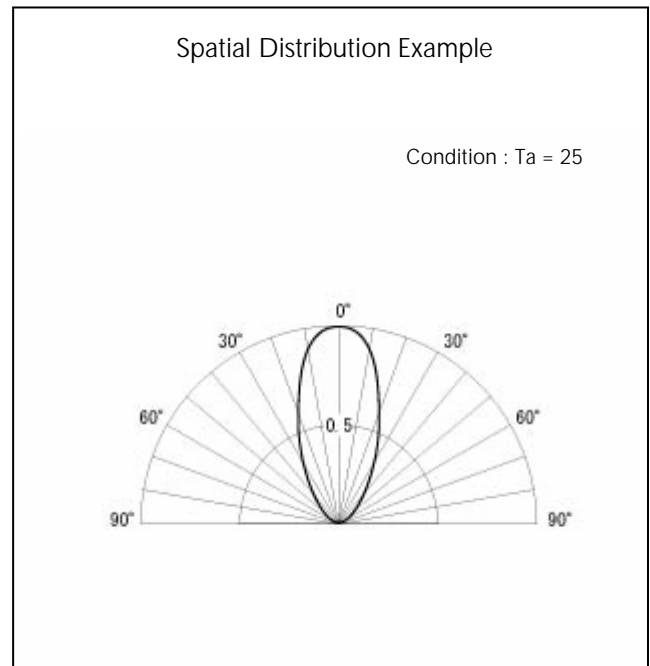
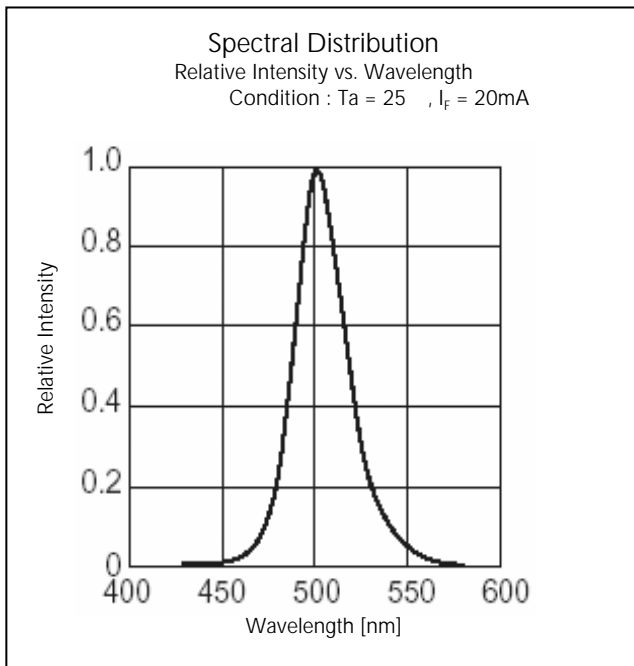

Technical Data(UC)

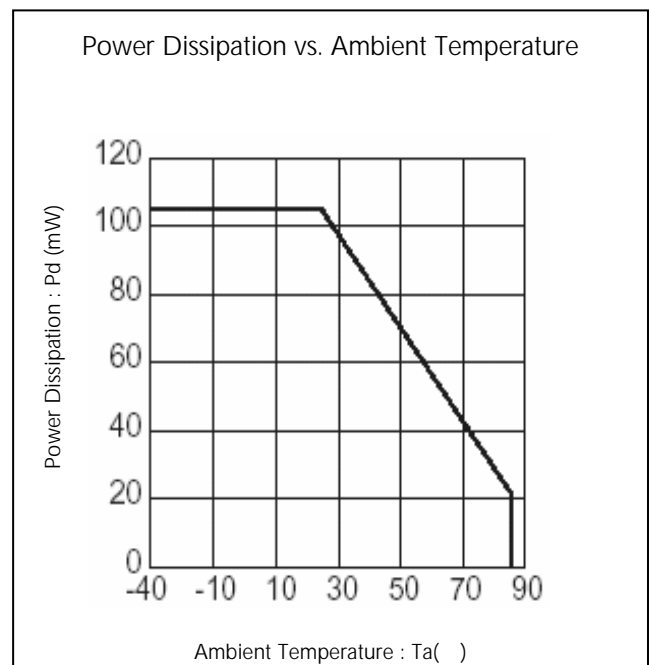
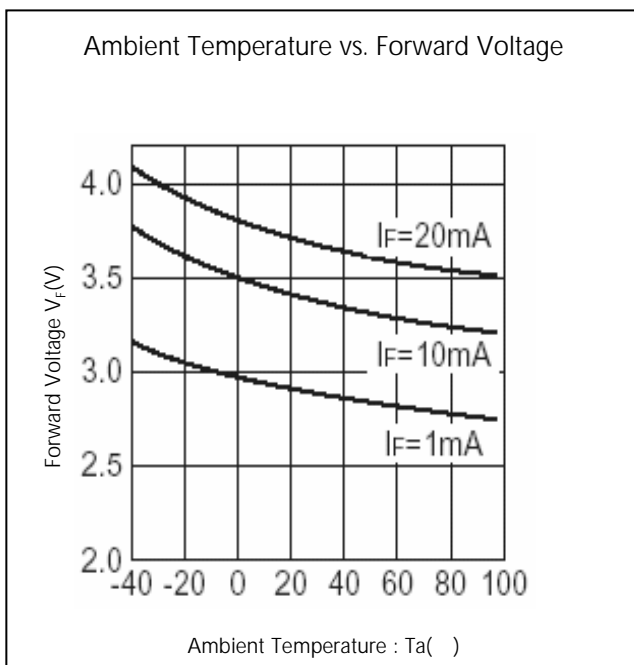
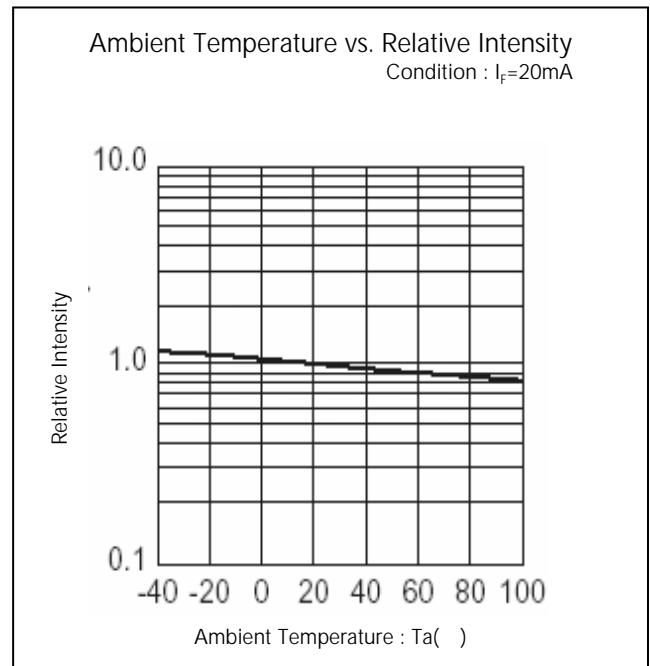
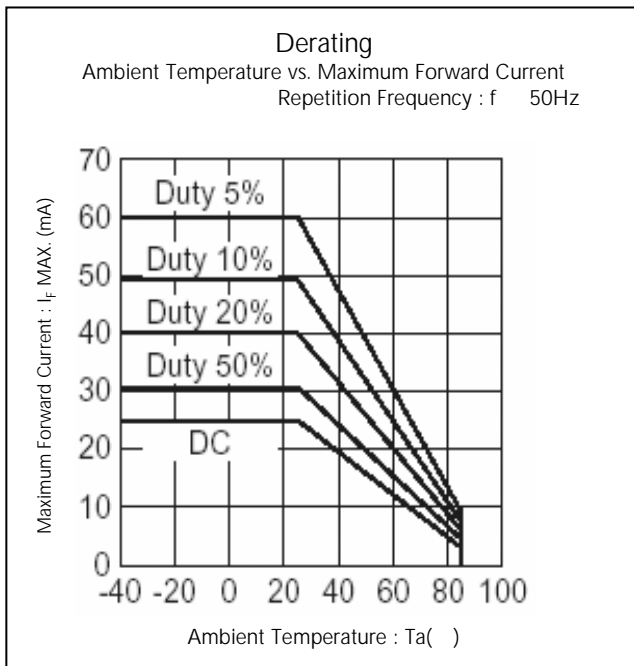

Technical Data(UC)

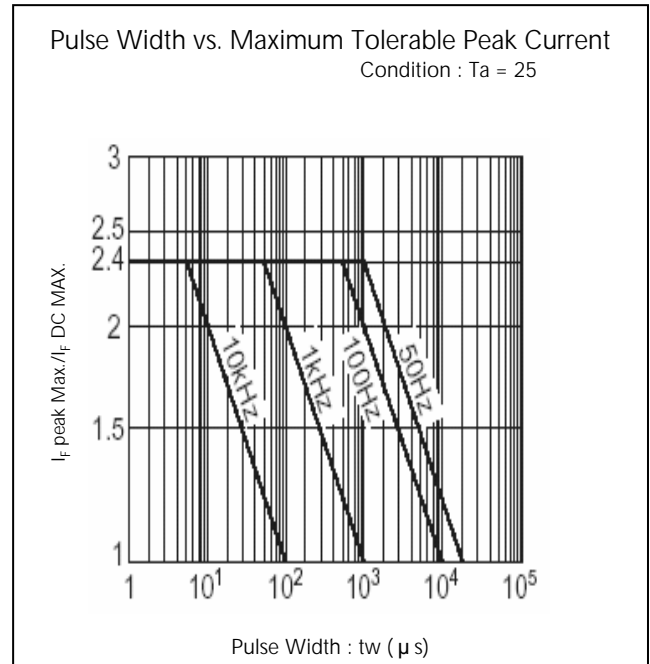
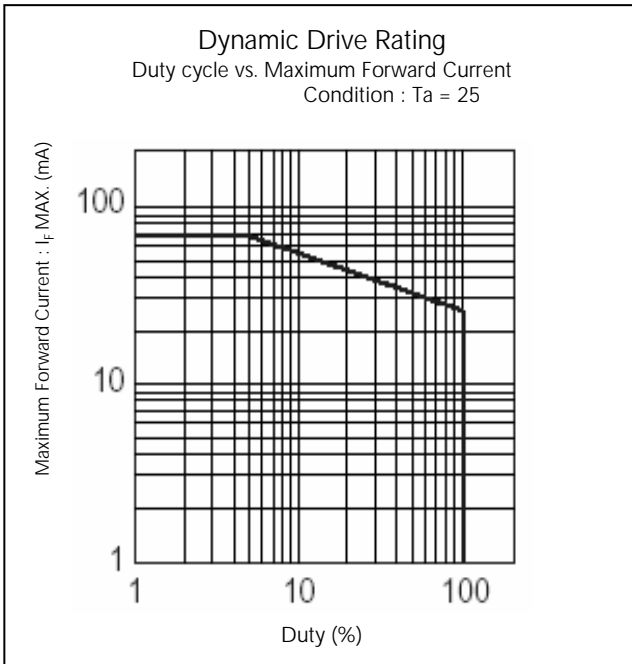

Technical Data(UG)

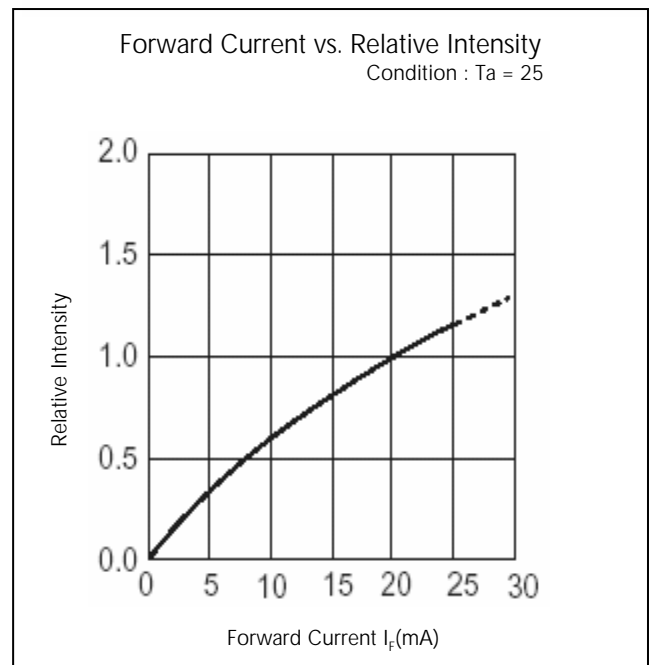
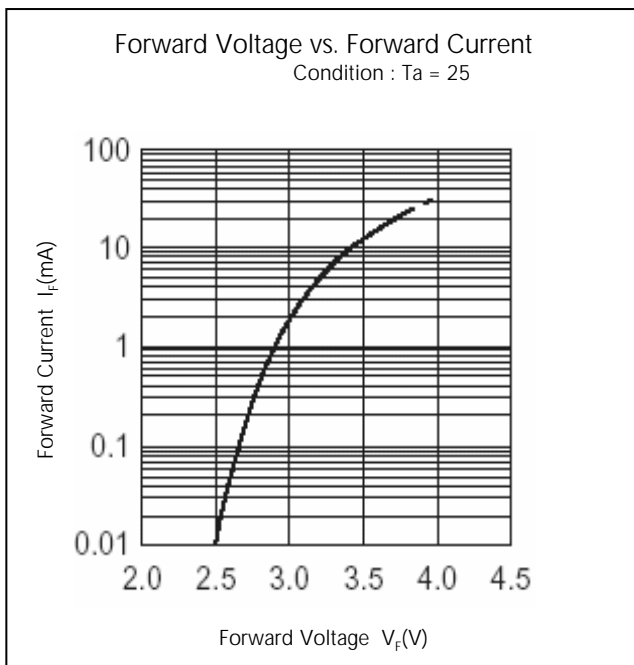
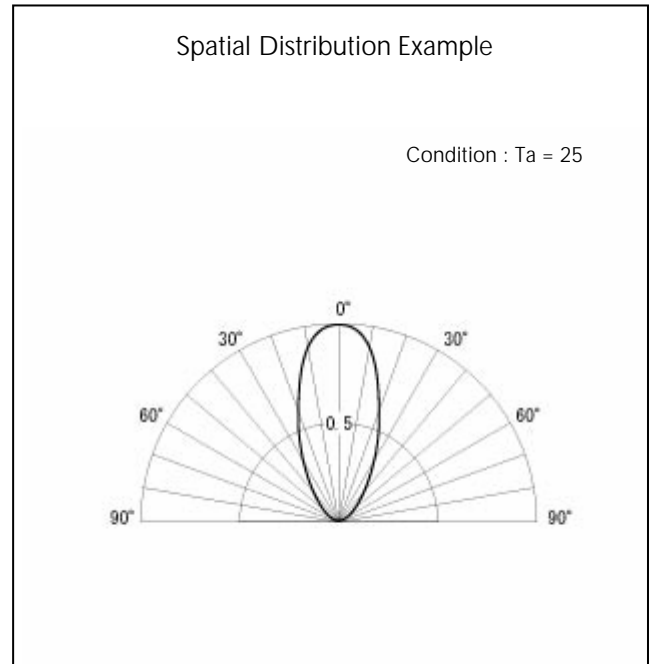
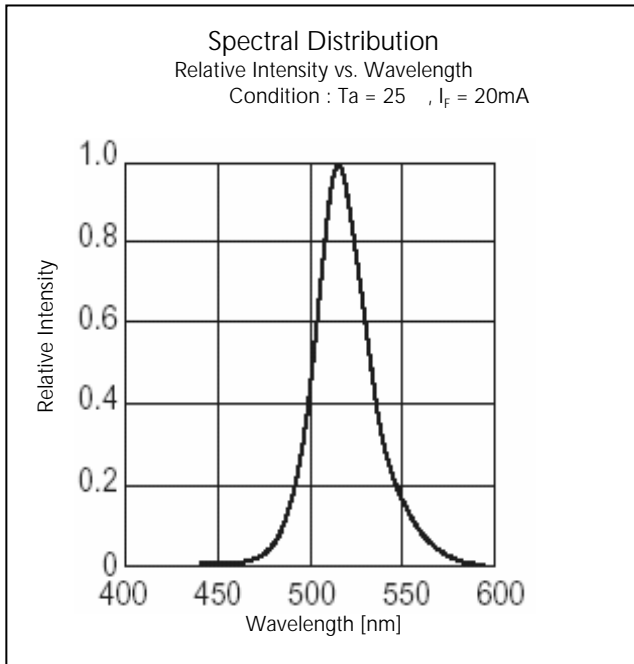

Technical Data(UG)

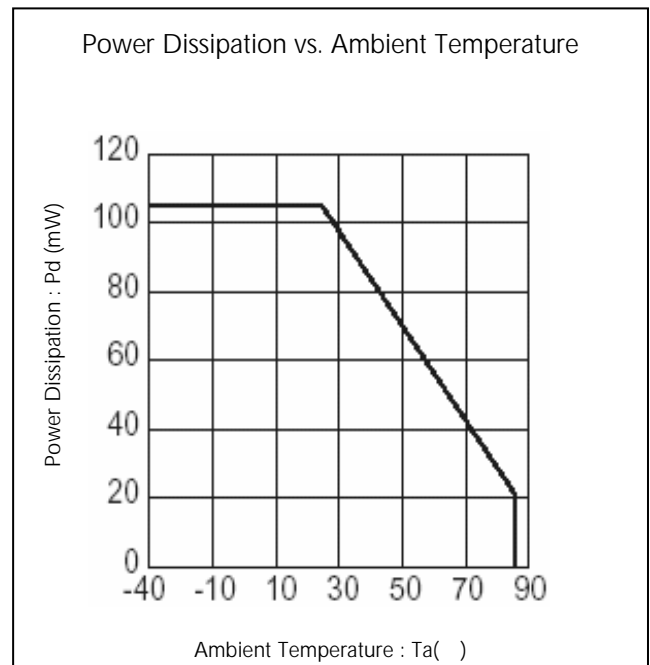
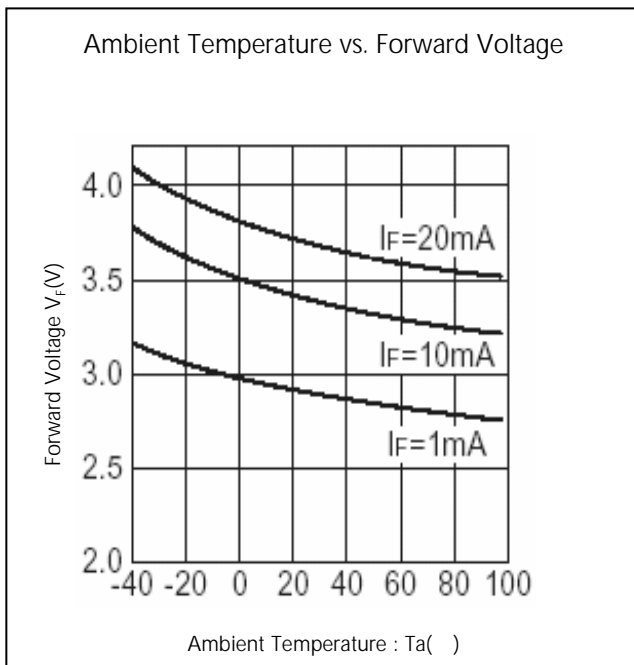
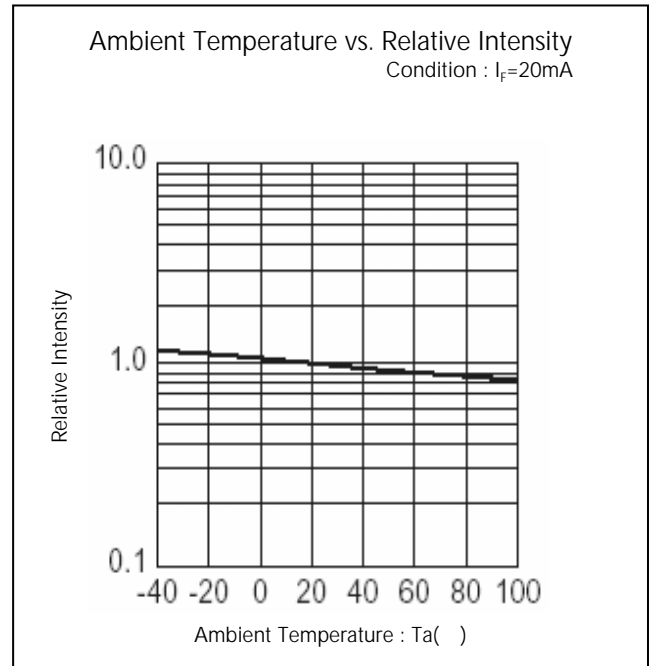
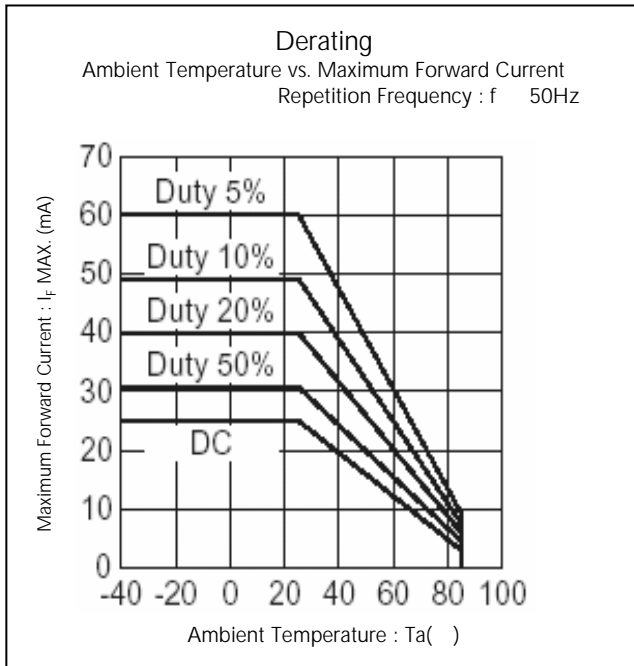

Technical Data(UG)

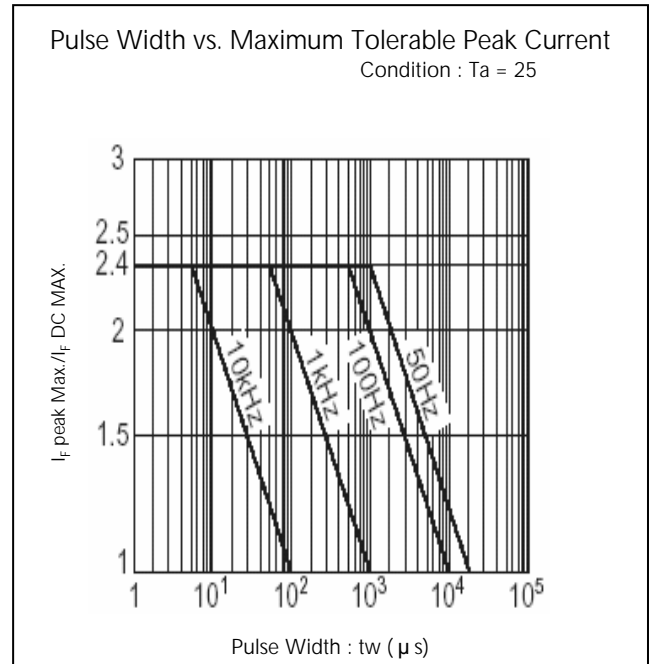
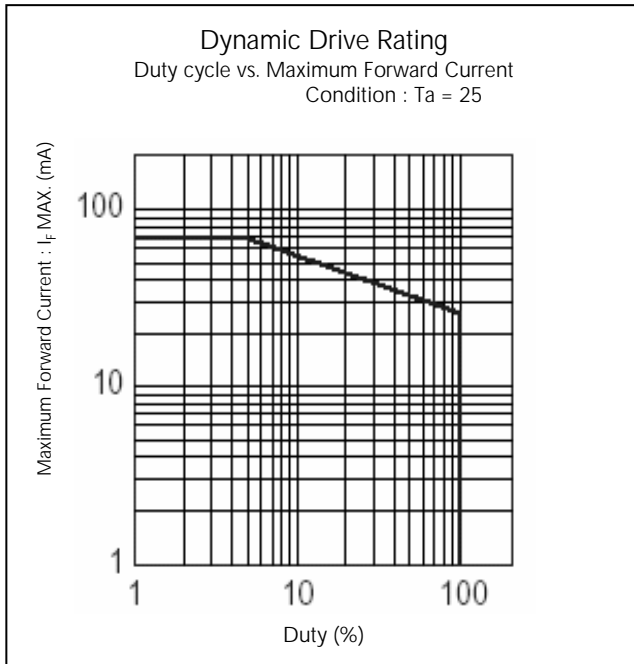

Technical Data(UY)

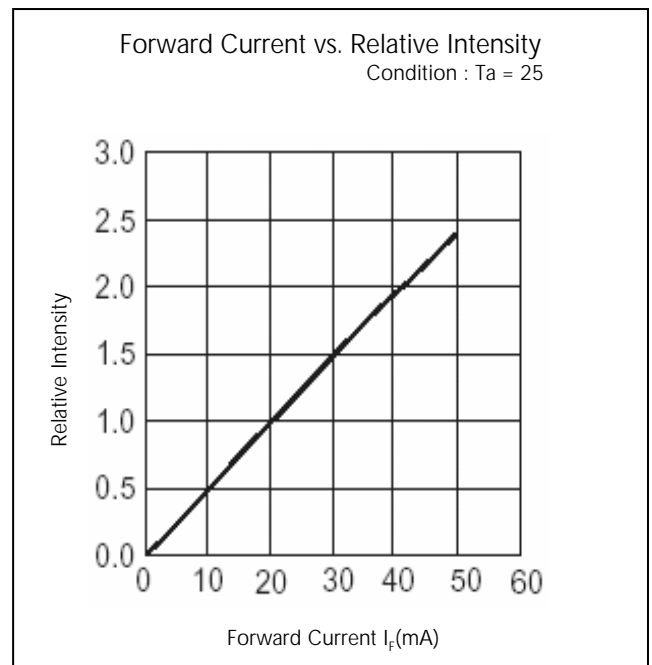
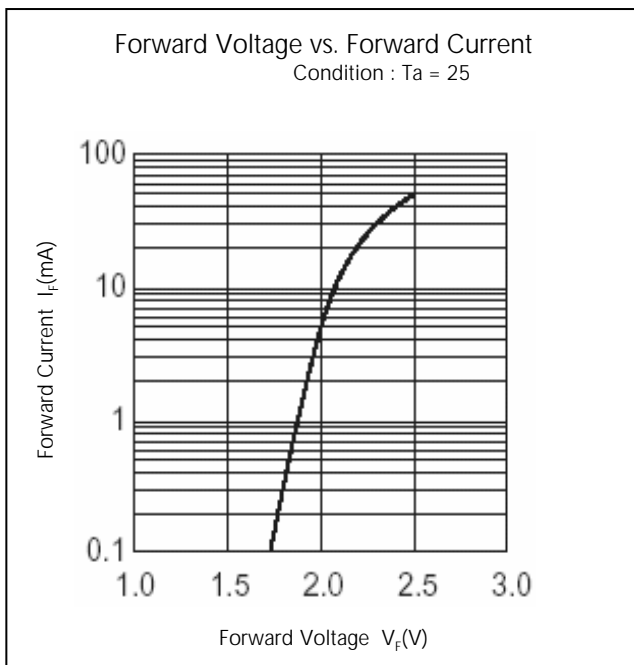
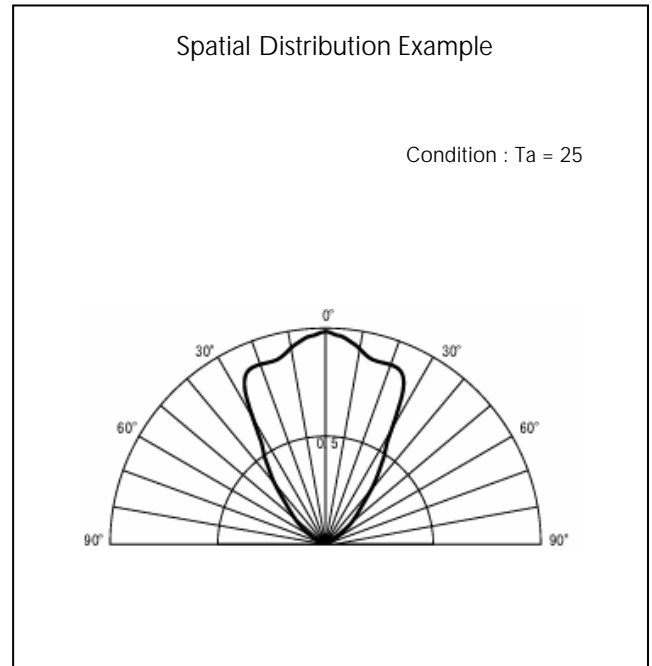
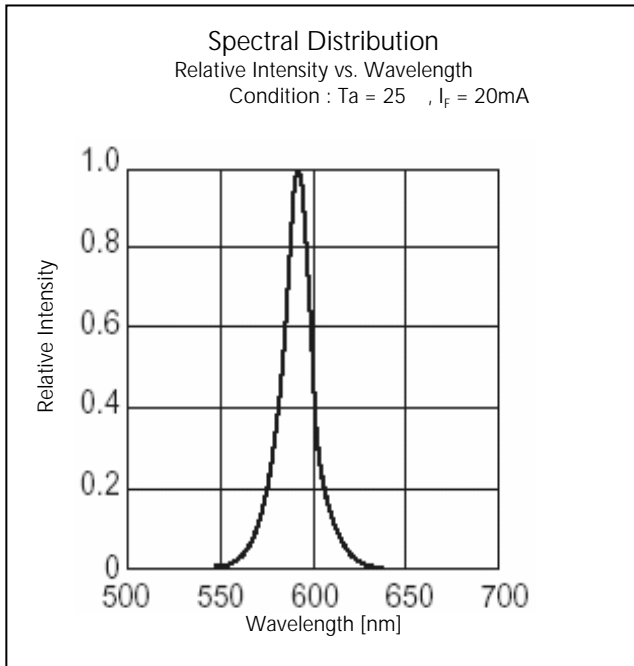

Technical Data(UY)

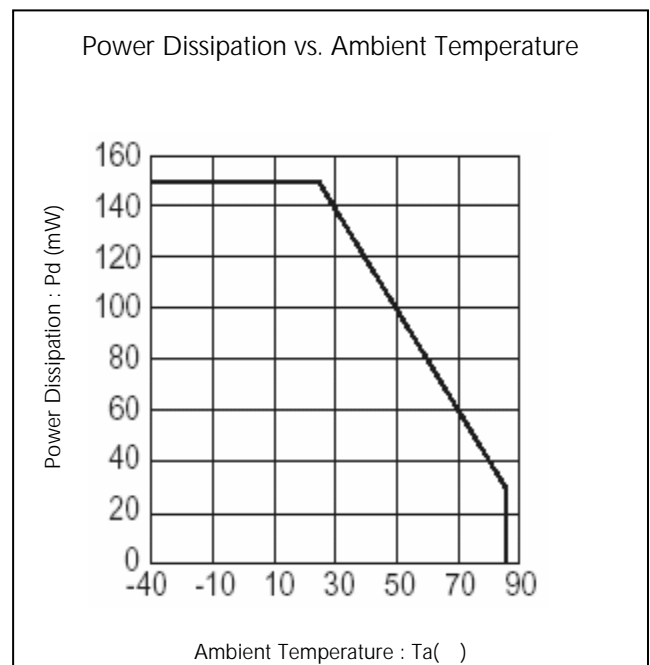
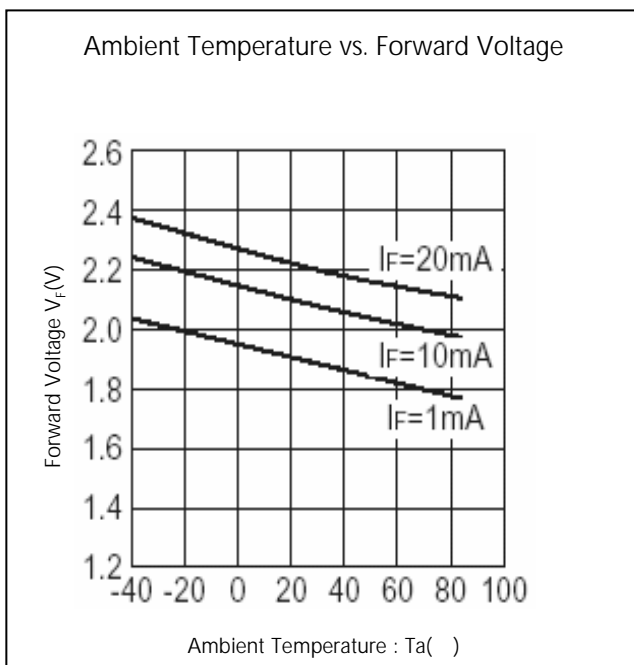
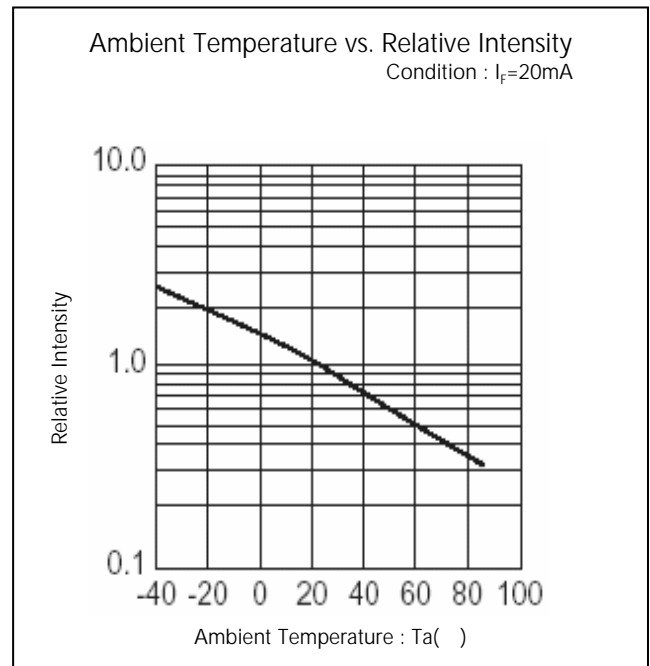
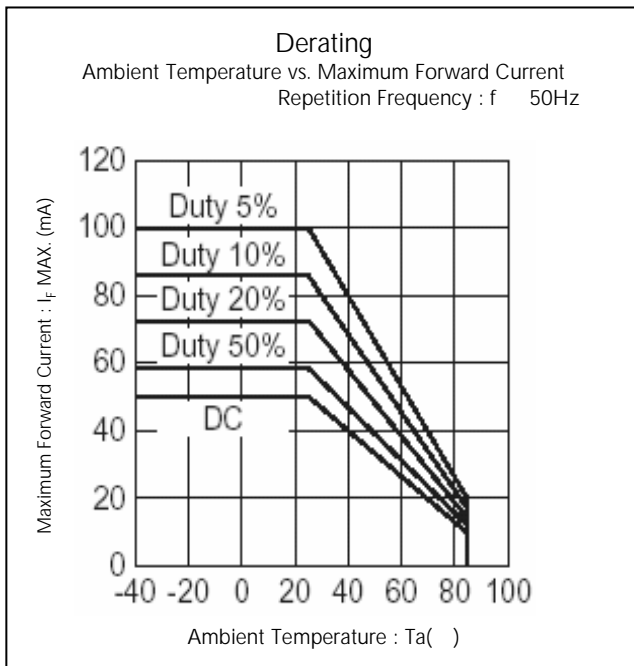

Technical Data(UY)

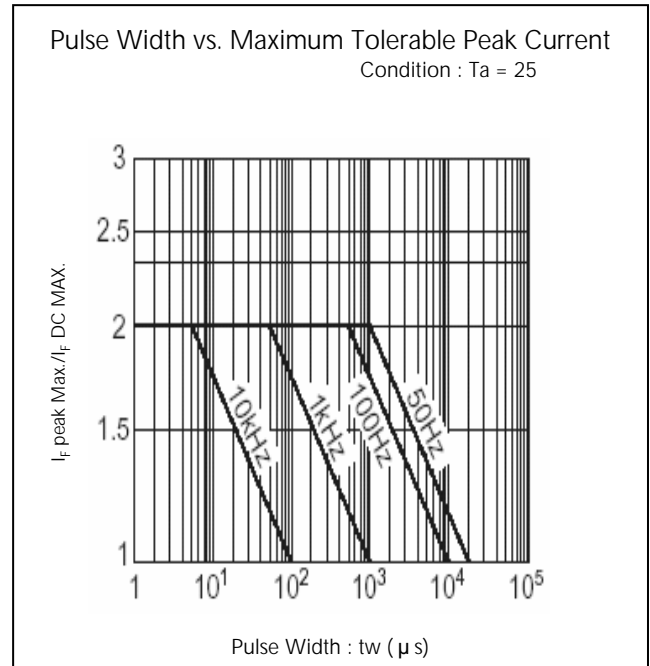
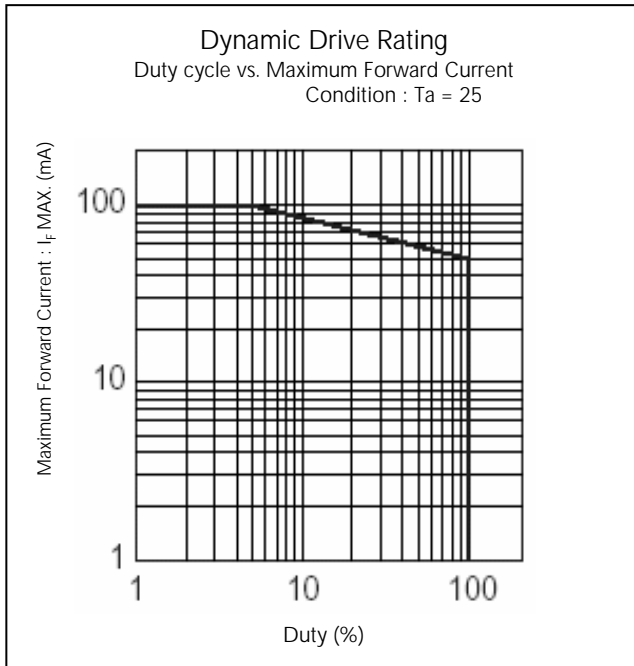

Technical Data(UR)

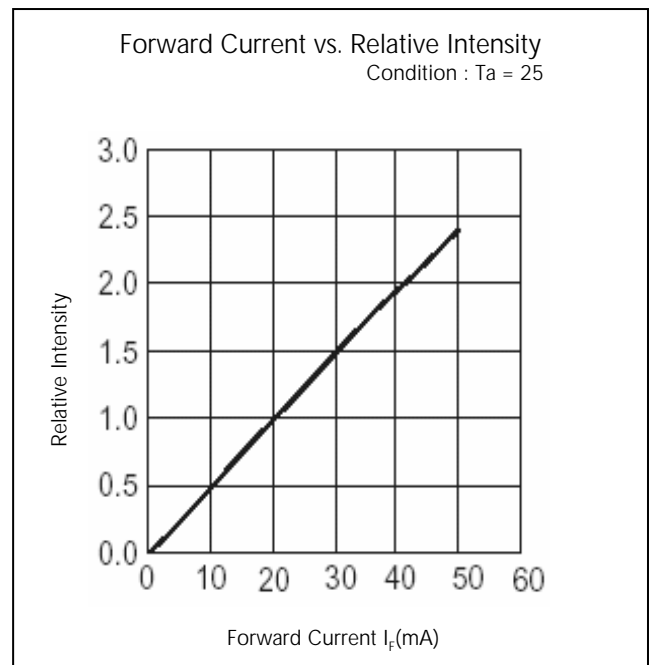
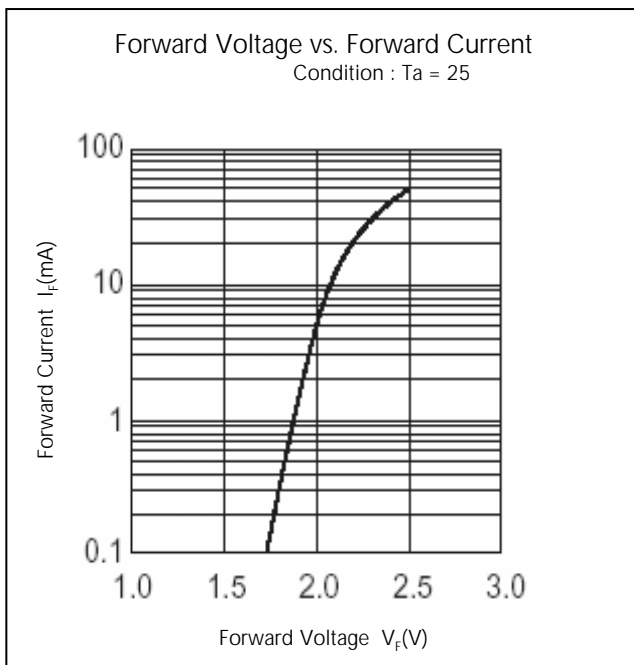
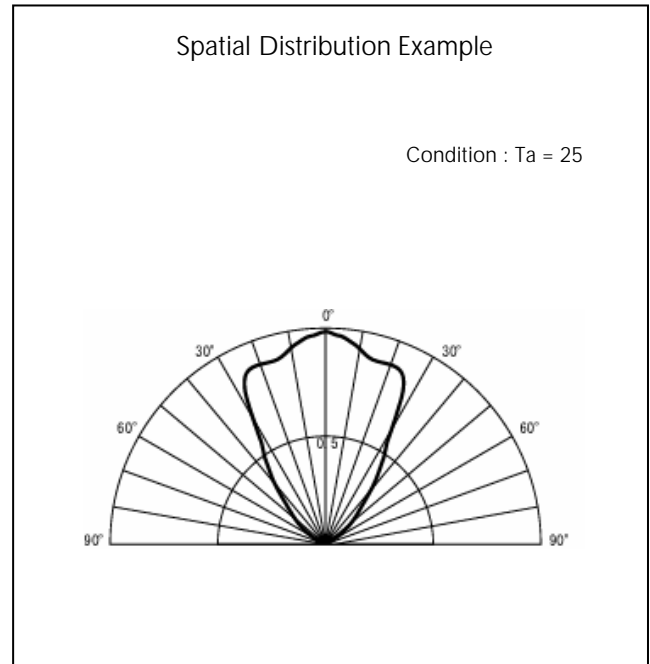
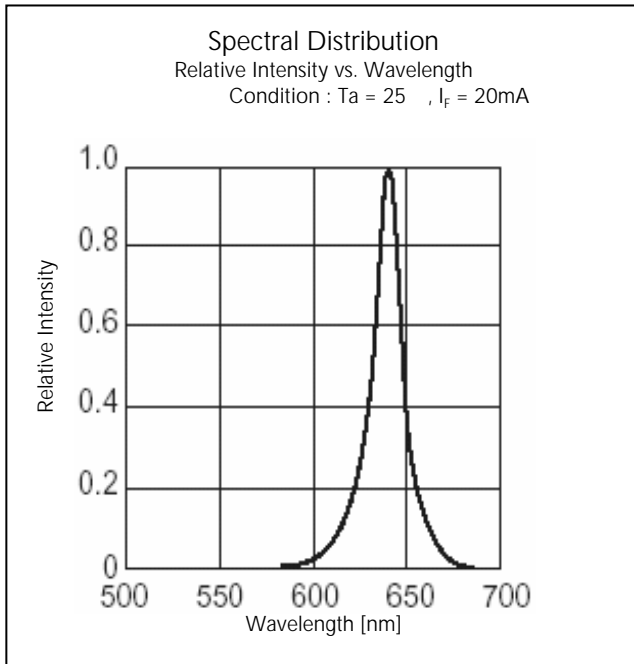

Technical Data(UR)

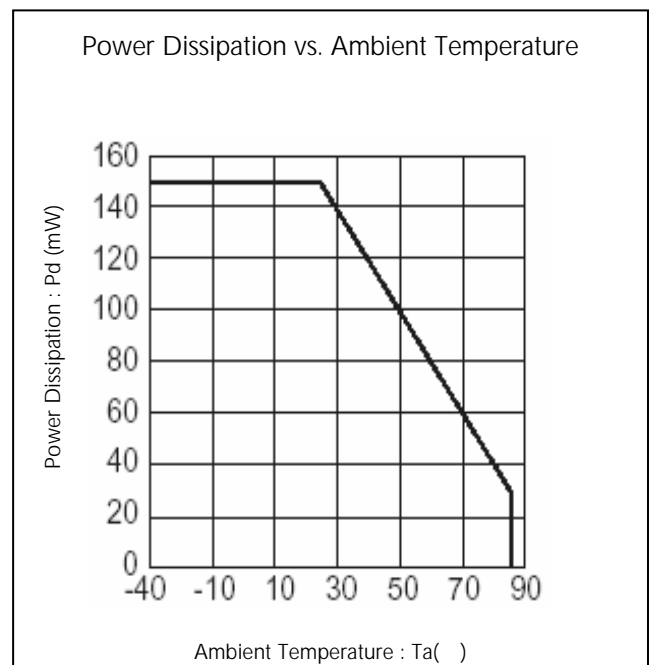
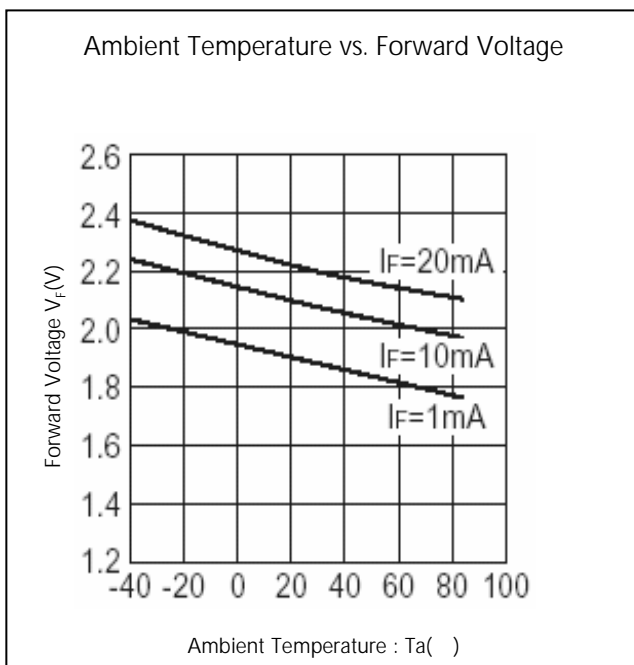
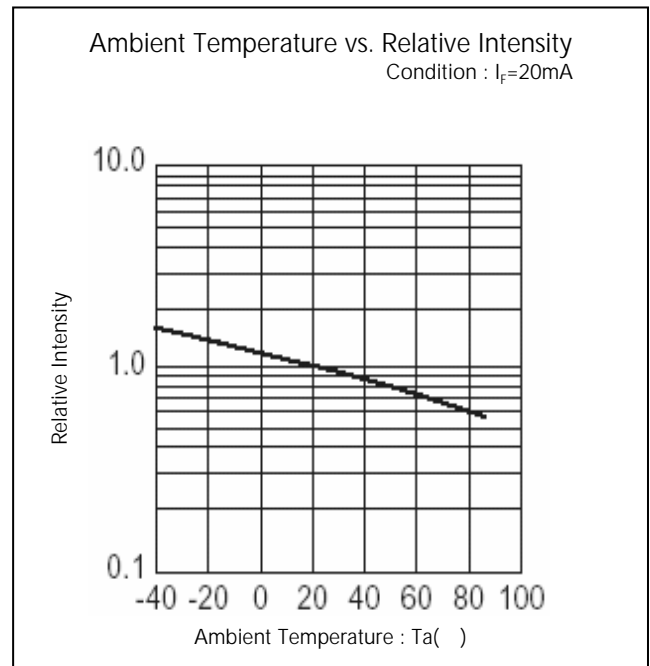
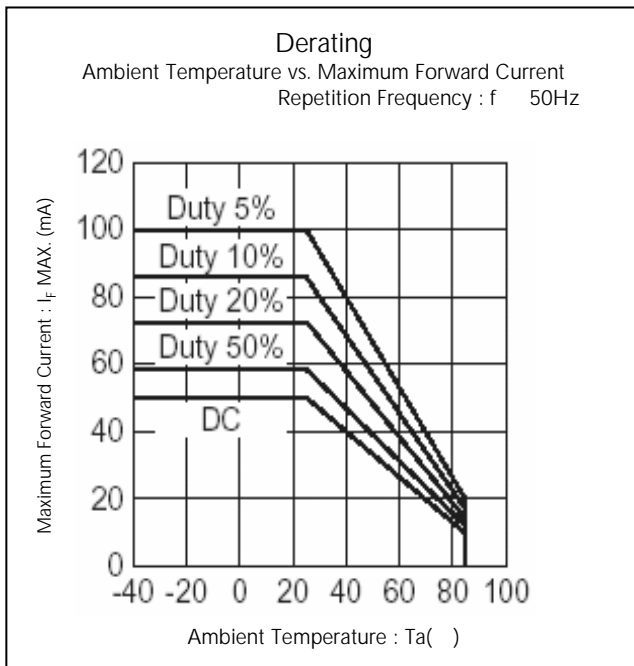

Technical Data(UR)

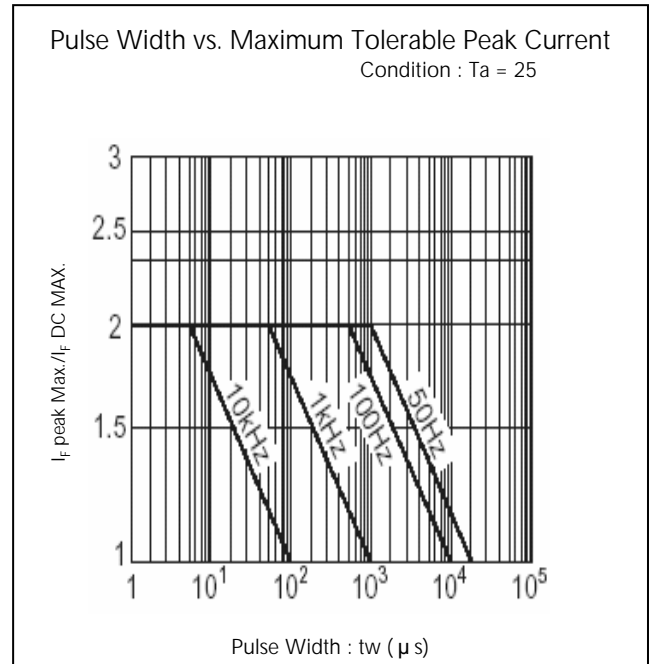
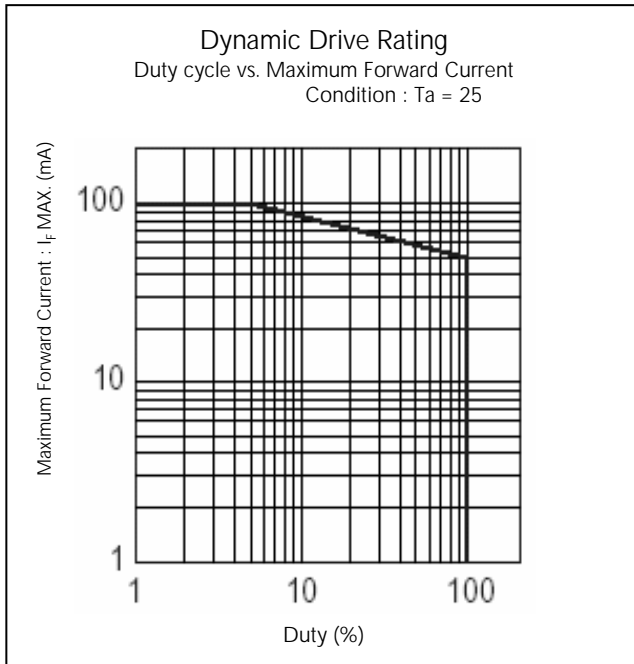

Package Dimensions

(Unit: mm)

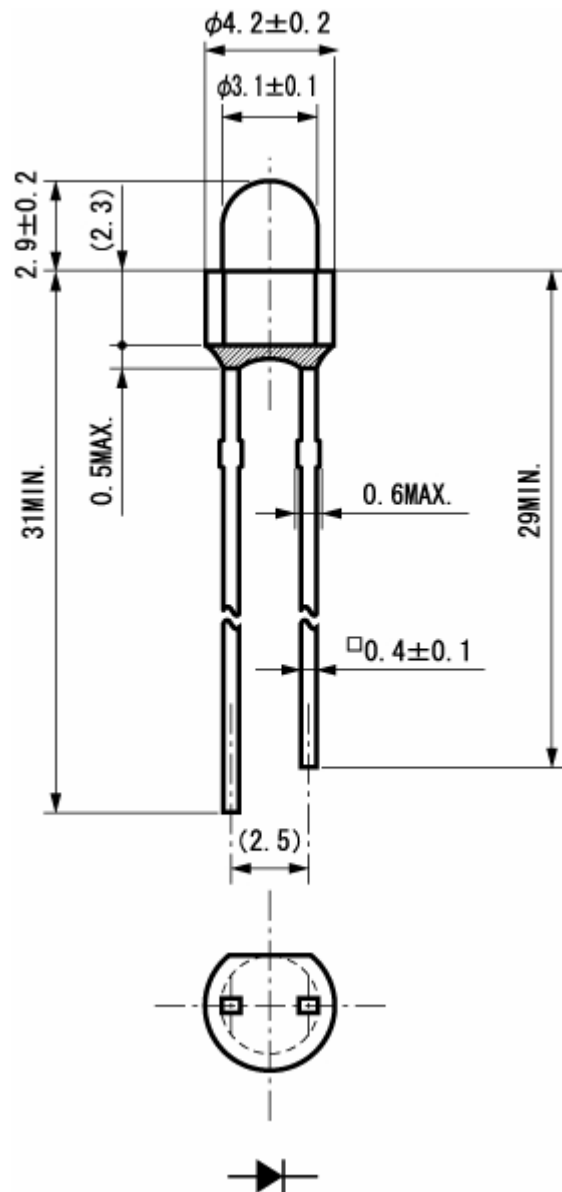

TTW (Through The Wave) soldering Conditions

Pre-heating	100 60 s	(MAX.) (MAX.)
Solder Bath Temp.	265	(MAX.)
Dipping Time	5 s	(MAX.)

- 1) The dip soldering process shall be 2 times maximum.
- 2) The product shall be cooled to normal temperature before the second dipping process.

Manual Soldering Conditions

Iron tip temp.	400	(MAX.)
Soldering time and frequency	3 s 2 times	(MAX.) (MAX.)

Reliability Testing Result

Reliability Testing Result	Applicable Standard	Testing Conditions	Duration	Failure
Room Temp. Operating Life	EIAJ ED-4701/100(101)	Ta = 25°C, If = Maximum Rated Current	1,000 h	0/25
Resistance to Soldering Heat	EIAJ ED-4701/300(302)	260±5°C, 3mm from package base	10sec	0/25
Temperature Cycling	EIAJ ED-4701/100(105)	Minimum Rated Storage Temperature(30min) ~Normal Temperature(15min) ~Maximum Rated Storage Temperature(30min) ~Normal Temperature(15min)	5 cycles	0/25
Wet High Temp. Storage Life	EIAJ ED-4701/100(103)	Ta = 60±2°C, RH = 90±5%	1,000 h	0/25
High Temp. Storage Life	EIAJ ED-4701/200(201)	Ta = Maximum Rated Storage Temperature	1,000 h	0/25
Low Temp. Storage Life	EIAJ ED-4701/200(202)	Ta = Minimum Rated Storage Temperature	1,000 h	0/25
Lead Tension	EIAJ ED-4701/400(401)	10N, 1time (□0.4 and Flat Package : 5N)	10sec	0/10
Vibration, Variable Frequency	EIAJ ED-4701/400(403)	98.1m/s ² (10G), 100 ~ 2KHz sweep for 20min., XYZ each direction	2 h	0/10

Failure Criteria

Items	Symbols	Conditions	Failure criteria
Luminous Intensity	Iv	If Value of each product Luminous Intensity	Testing Min. Value < Spec. Min. Value x 0.5
Forward Voltage	V _F	If Value of each product Forward Voltage	Testing Max. Value ≥ Spec. Max. Value x 1.2
Reverse Current	I _R	V _R = Maximum Rated Reverse Voltage V	Testing Max. Value ≥ Spec. Max. Value x 2.5
Cosmetic Appearance	-	-	No notable, decoloration, deformation and cracking

Special Notice to Customers Using the Products and Technical Information Shown in This Data Sheet

- 1) The technical information shown in the data sheets are limited to the typical characteristics and circuit examples of the referenced products. It does not constitute the warranting of industrial property nor the granting of any license.
- 2) For the purpose of product improvement, the specifications, characteristics and technical data described in the data sheets are subject to change without prior notice. Therefore it is recommended that the most updated specifications be used in your design.
- 3) When using the products described in the data sheets, please adhere to the maximum ratings for operating voltage, heat dissipation characteristics, and other precautions for use. We are not responsible for any damage which may occur if these specifications are exceeded.
- 4) The products described in the data sheets are made to be used in standard electronic applications such as office automation appliances, communication devices, audio visual, home appliances, and measuring instruments.
- 5) If the products in the data sheets are to be used for purposes other than the above which requires high level reliability and safety where failure and or malfunction of the product may cause death or other serious effects on the human body such as airplane, space activity, transportation, medical, nuclear), please contact our sales personnel.
- 6) In order to export the products or technologies described in this data sheet which are under the "Foreign Exchange and Foreign Trade Control Law," it is necessary to first obtain an export permit from the Japanese government.
- 7) No part of this data sheet may be reprinted or reproduced without prior written permission from Stanley Electric Co., Ltd.
- 8) The most updated edition of this data sheet can be obtained from the address below:
<http://www.stanley-components.com>