

部品配置図

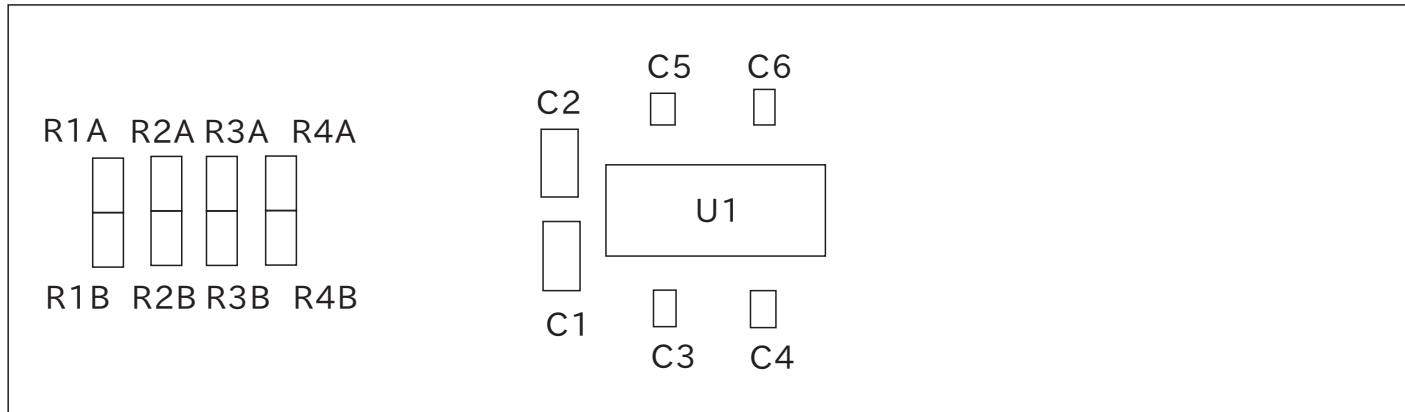

form	diameter	number	
a	0.300	16	メッキ有
b	0.500	29	メッキ有
c	0.800	48	メッキ有

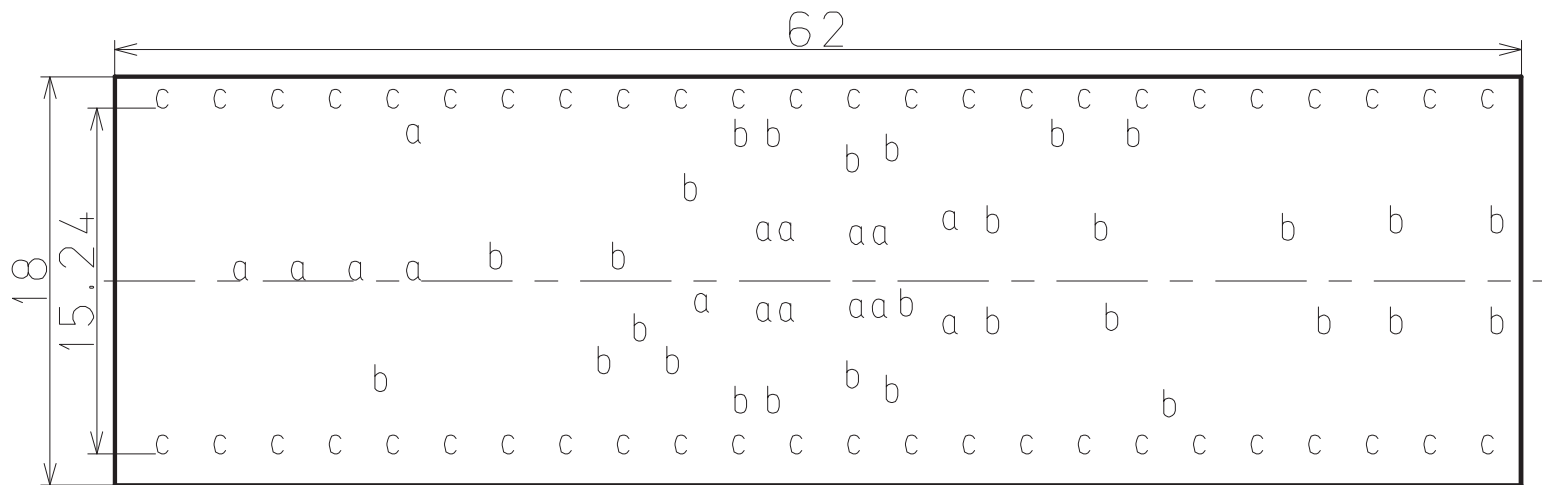

穴加工図

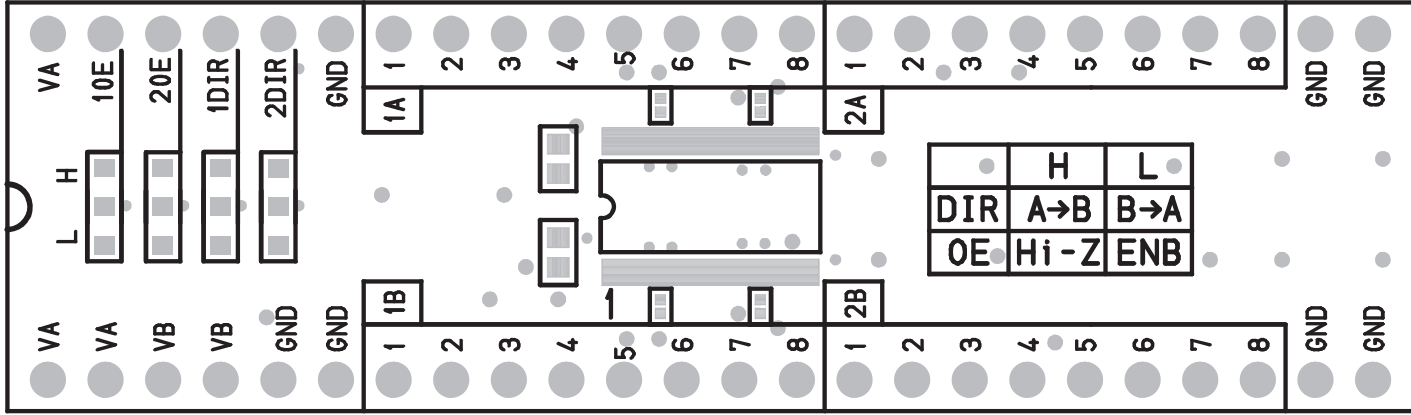

部品面シルク 部品面レジスト

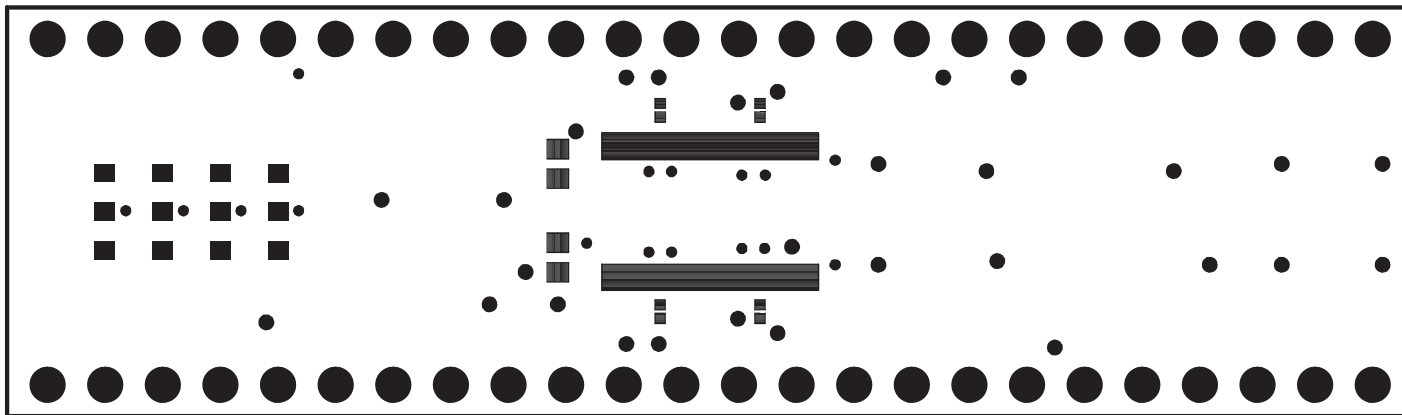

部品面レジスト

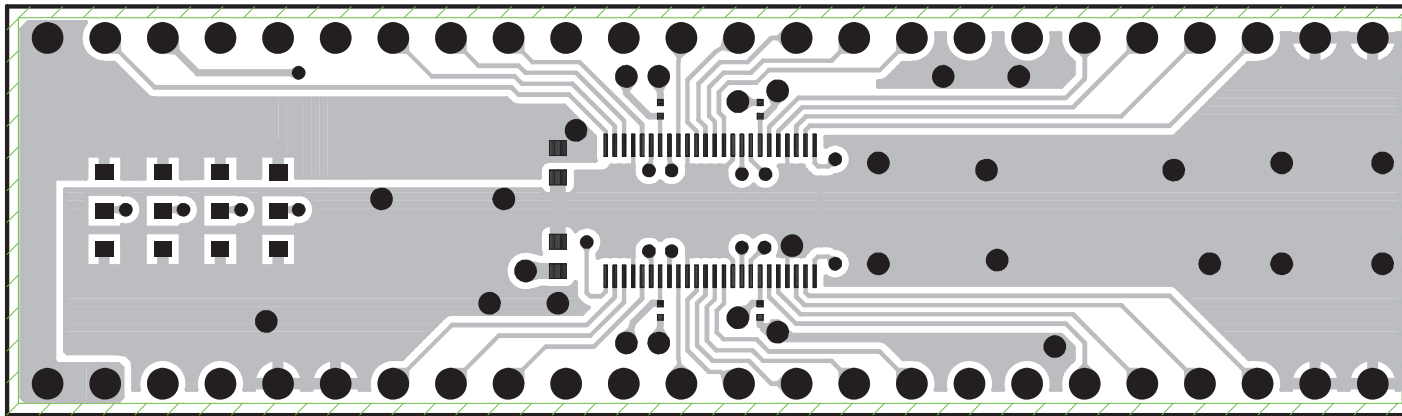

TOP (部品面パターン)

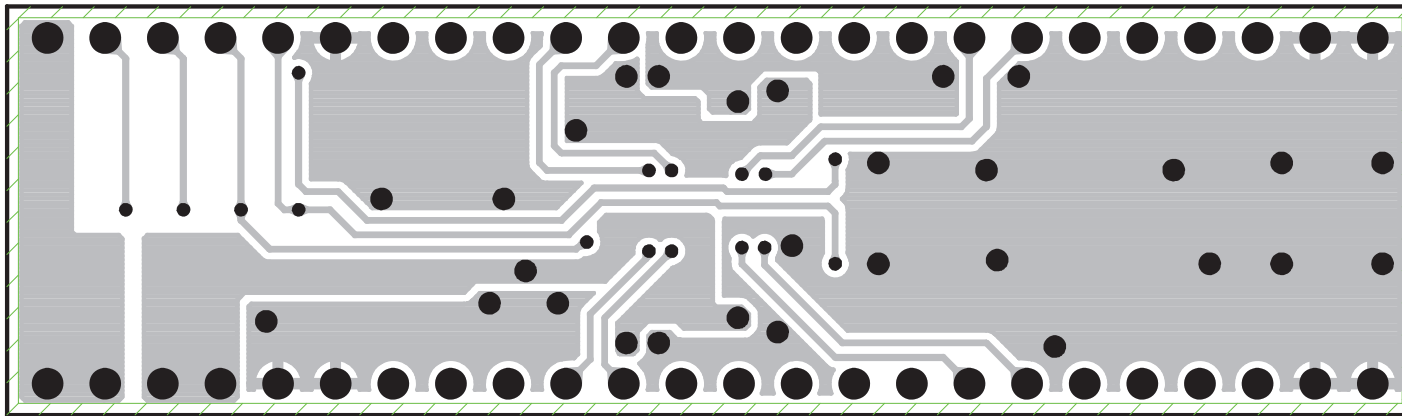

BOT (半田面パターン)

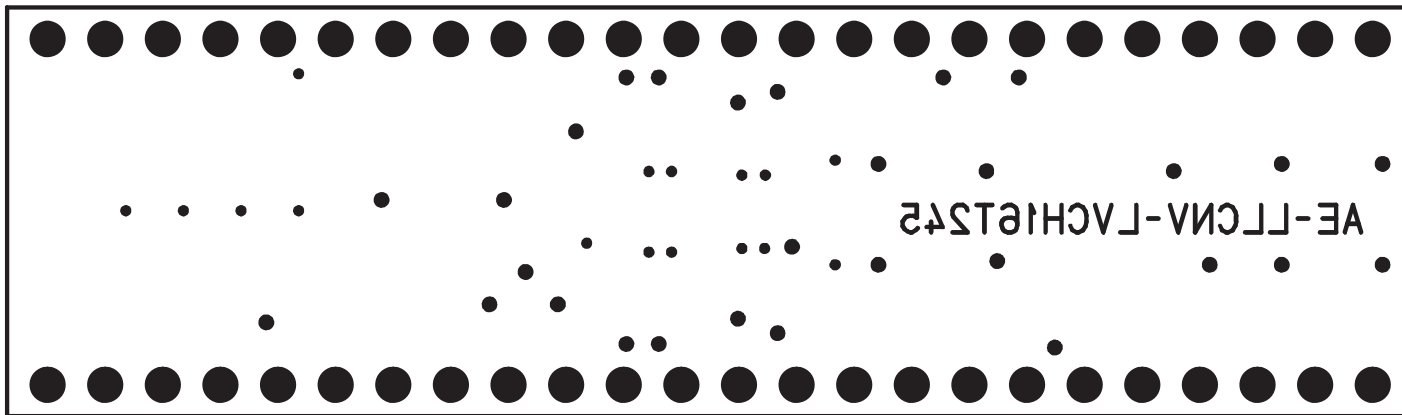

半田面レジスト

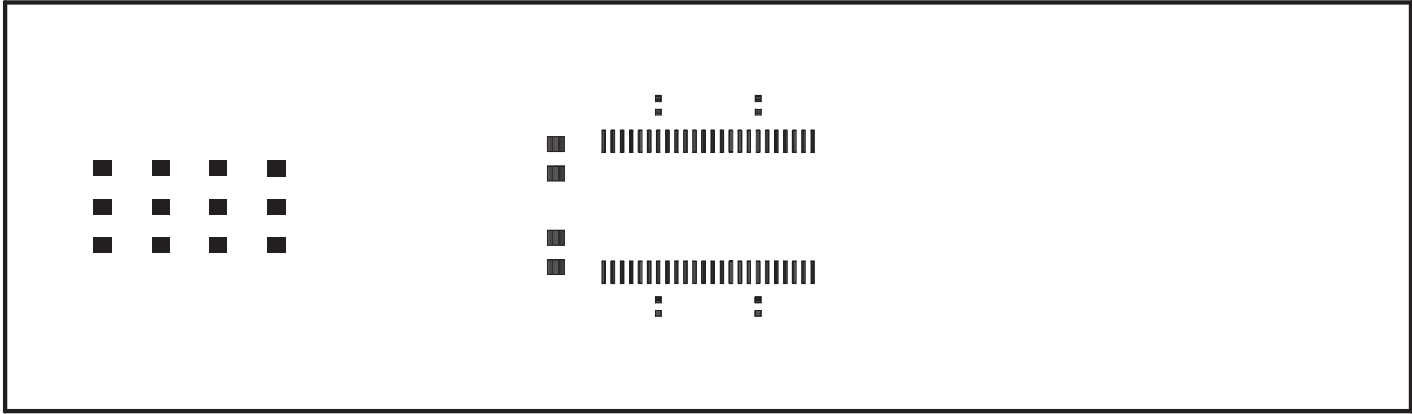

部品面メタル