

N-Channel Enhancement Mode Power MOSFET

MTB30N06I3

BV_{DSS}	60V
$I_D @ V_{GS} = 10V, T_C = 25^\circ C$	22A
$R_{DS(ON)} @ V_{GS} = 10V, I_D = 18A$	27mΩ (typ)
$R_{DS(ON)} @ V_{GS} = 4.5V, I_D = 10A$	31mΩ (typ)

Features

- Low Gate Charge
- Simple Drive Requirement
- Fast Switching Characteristic
- RoHS compliant package

Symbol

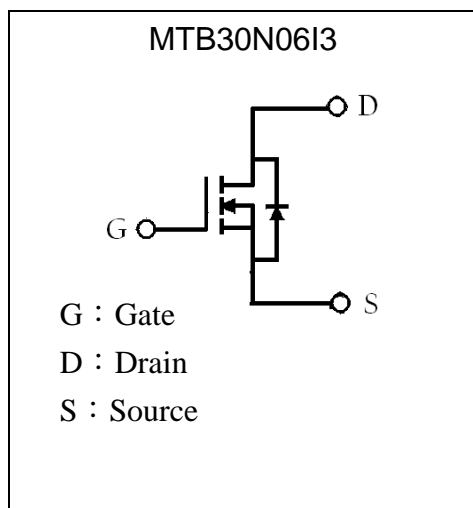

Outline

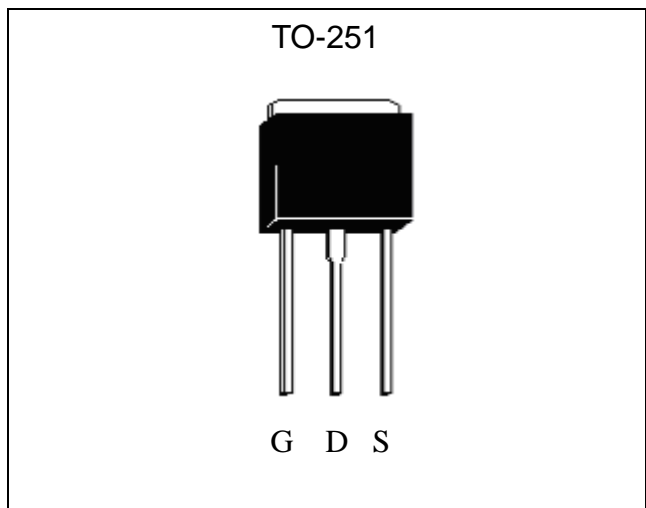

Ordering Information

Device	Package	Shipping
MTB30N06I3-0-UA-G	TO-251 (Pb-free lead plating and halogen-free package)	80 pcs / tube, 50 tubes / box

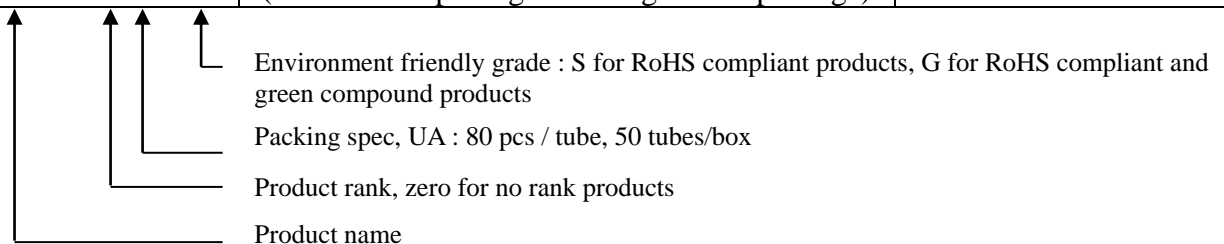



Absolute Maximum Ratings (Ta=25°C)

Parameter	Symbol	Limits	Unit
Drain-Source Voltage	V _{DS}	60	V
Gate-Source Voltage	V _{GS}	±20	
Continuous Drain Current @ V _{GS} =10V, T _C =25°C	I _D	22	A
Continuous Drain Current @ V _{GS} =10V, T _C =100°C		15.5	
Pulsed Drain Current	I _{DM}	50 *1	
Single Pulse Avalanche Current @ L=0.1mH	I _{AS}	12	
Single Pulse Avalanche Energy @ L=0.5mH, I _{AS} =8A, V _{DD} =25V	E _{AS}	16 *2	mJ
Total Power Dissipation (T _C =25°C)	P _D	36	W
Total Power Dissipation (T _C =100°C)		18	
Operating Junction and Storage Temperature	T _j , T _{stg}	-55~+175	°C

Note : *1. Pulse width limited by safe operating area

*2. 100% tested by conditions of L=0.5mH, I_{AS}=4A, V_{GS}=10V, V_{DD}=25V

Thermal Data

Parameter	Symbol	Value	Unit
Thermal Resistance, Junction-to-case, max	R _{th,j-c}	4.16	°C/W
Thermal Resistance, Junction-to-ambient, max	R _{th,j-a}	110	
Thermal Resistance, Junction-to-ambient, max (Note)		50	

Note : The device is mounted on 1 in² FR-4 board with 2 oz. copper, in a still air environment with T_A=25 °C

Characteristics (T_j=25°C, unless otherwise specified)

Symbol	Min.	Typ.	Max.	Unit	Test Conditions
Static					
BV _{DSS}	60	-	-	V	V _{GS} =0V, I _D =250μA
ΔBV _{DSS} /ΔT _j	-	0.05	-	V/°C	Reference to 25°C, I _D =1mA
V _{GS(th)}	1.0	-	2.5	V	V _{DS} = V _{GS} , I _D =250μA
G _{FS}	-	10	-	S	V _{DS} =10V, I _D =18A
I _{GSS}	-	-	±100	nA	V _{GS} =±20V, V _{DS} =0V
I _{DSS}	-	-	1	μA	V _{DS} =48V, V _{GS} =0V
	-	-	25		V _{DS} =48V, V _{GS} =0V, T _j =150°C
*R _{DS(ON)}	-	27	36	mΩ	V _{GS} =10V, I _D =18A
*R _{DS(ON)}	-	31	45		V _{GS} =4.5V, I _D =12A
Dynamic					
*Q _g	-	12.3	-	nC	I _D =18A, V _{DS} =48V, V _{GS} =4.5V
*Q _{gs}	-	3.2	-		
*Q _{gd}	-	6.1	-		



*td(ON)	-	7	-	ns	V _{DS} =30V, I _D =18A, V _{GS} =10V, R _G =3.3Ω
*tr	-	7.6	-		
*td(OFF)	-	42.4	-		
*tf	-	6.4	-		
Ciss	-	978	-	pF	V _{GS} =0V, V _{DS} =25V, f=1MHz
Coss	-	63	-		
Crss	-	53	-		
Rg	-	5.7	-	Ω	f=1MHz
Source-Drain Diode					
*V _{SD}	-	0.91	1.3	V	I _S =18A, V _{GS} =0V
*trr	-	13.5	-	ns	I _F =18A, V _{GS} =0V, dI _F /dt=100A/μs
*Qrr	-	11.6	-	nC	

*Pulse Test : Pulse Width ≤300μs, Duty Cycle≤2%

Typical Characteristics

Typical Output Characteristics

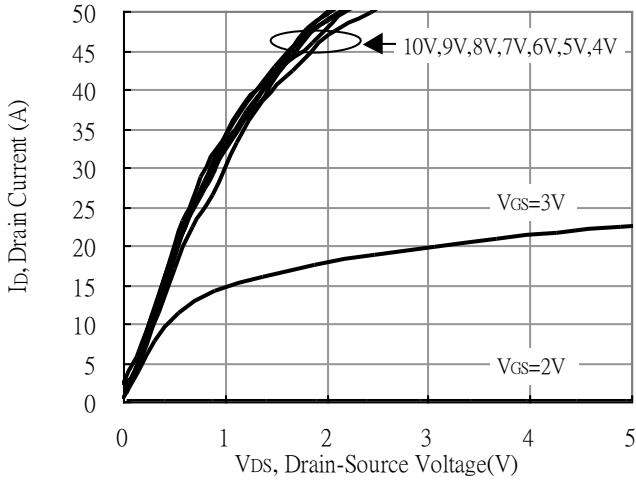

Brekdown Voltage vs Ambient Temperature

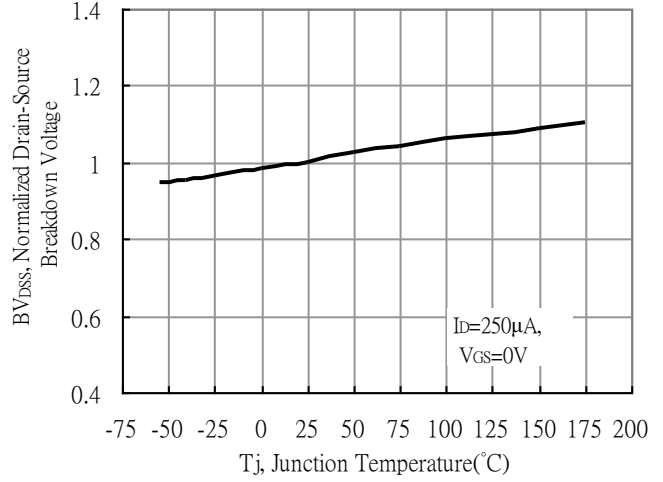

Static Drain-Source On-State resistance vs Drain Current

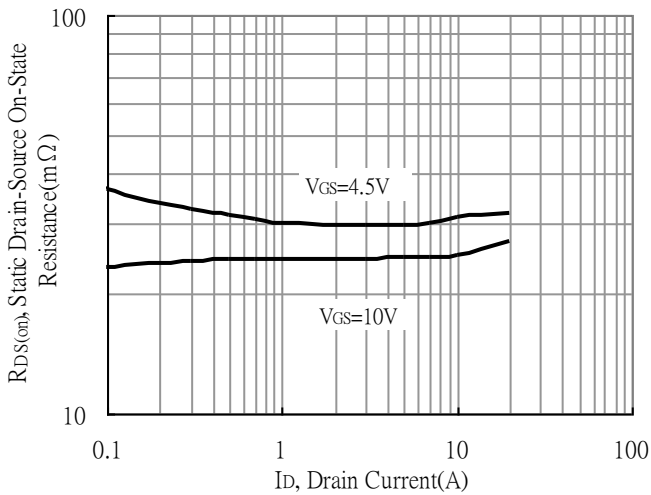

Reverse Drain Current vs Source-Drain Voltage

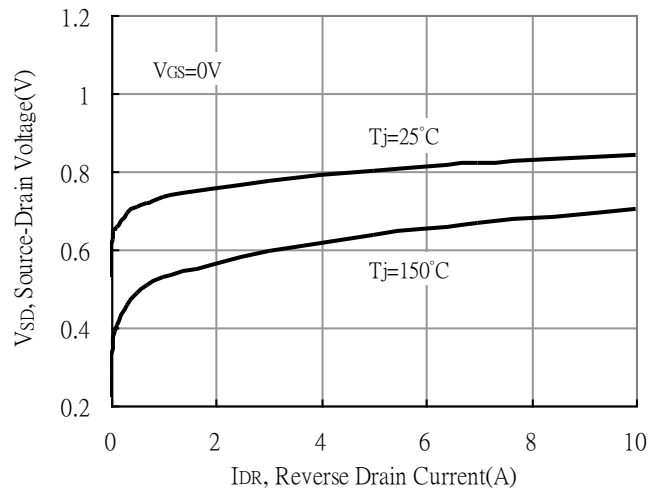

Static Drain-Source On-State Resistance vs Gate-Source Voltage

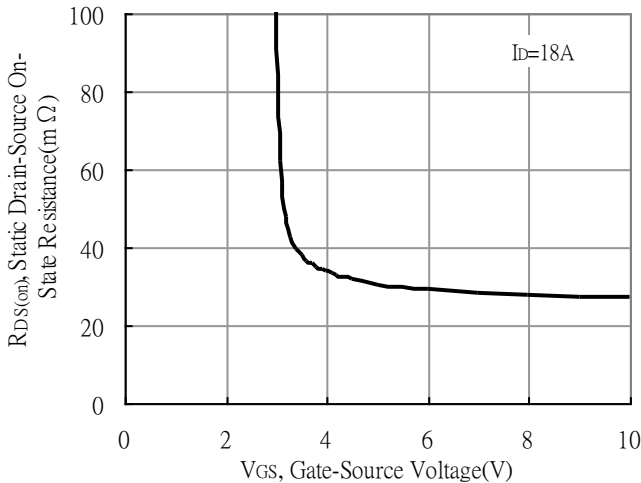

Drain-Source On-State Resistance vs Junction Temperature

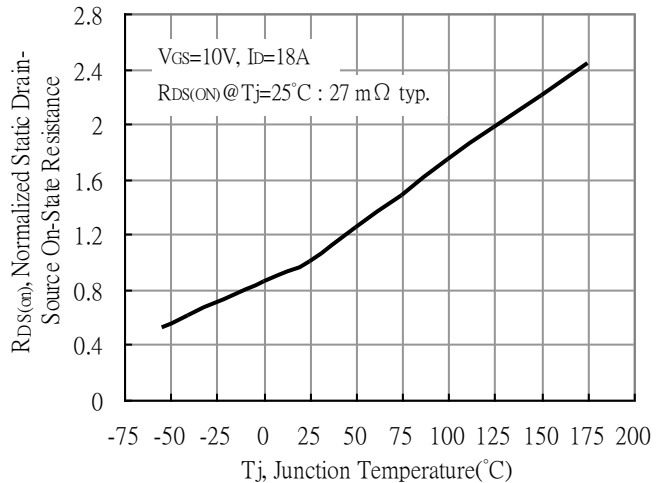

Typical Characteristics(Cont.)

Capacitance vs Drain-to-Source Voltage

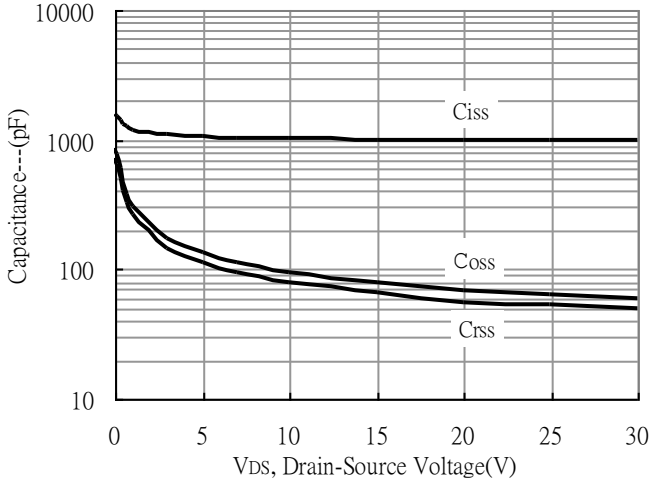

Threshold Voltage vs Junction Temperature

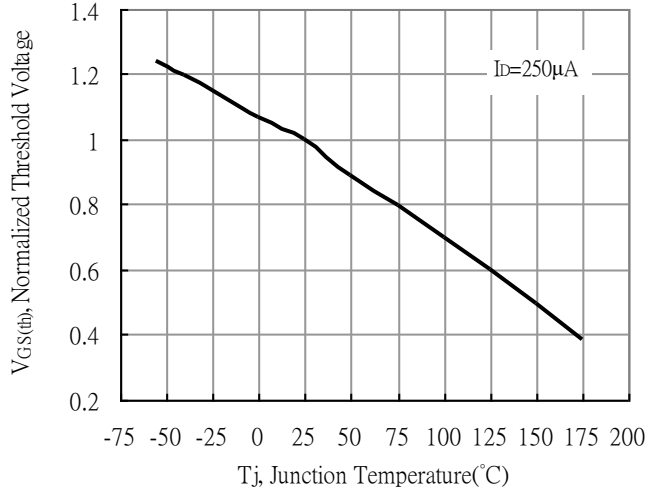

Forward Transfer Admittance vs Drain Current

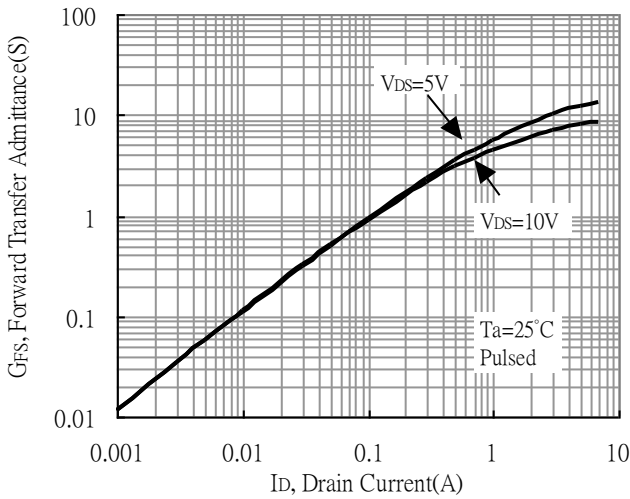

Gate Charge Characteristics

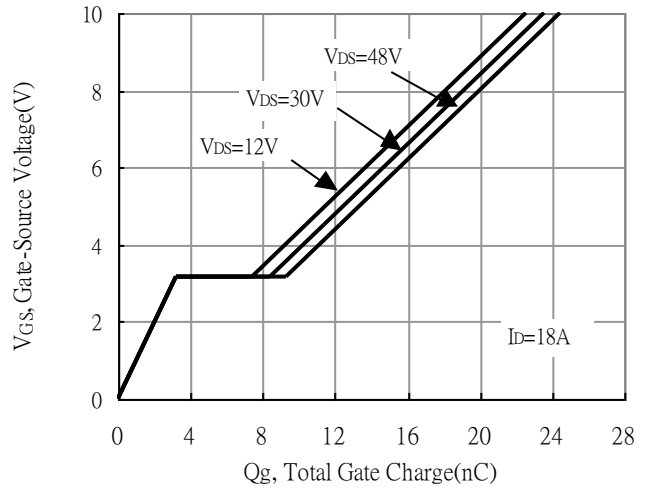

Maximum Safe Operating Area

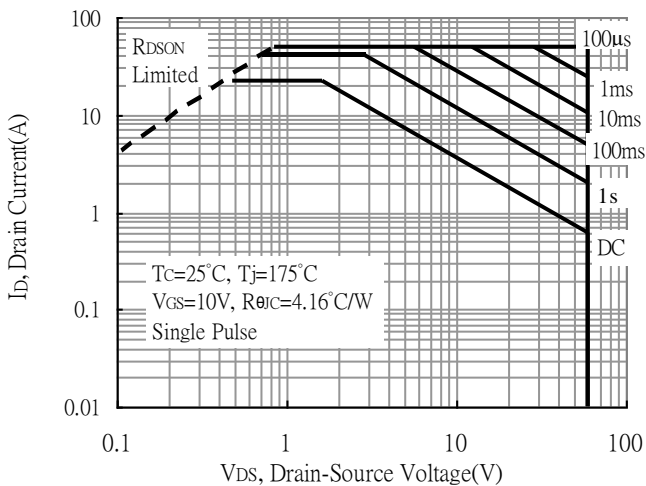

Maximum Drain Current vs Case Temperature

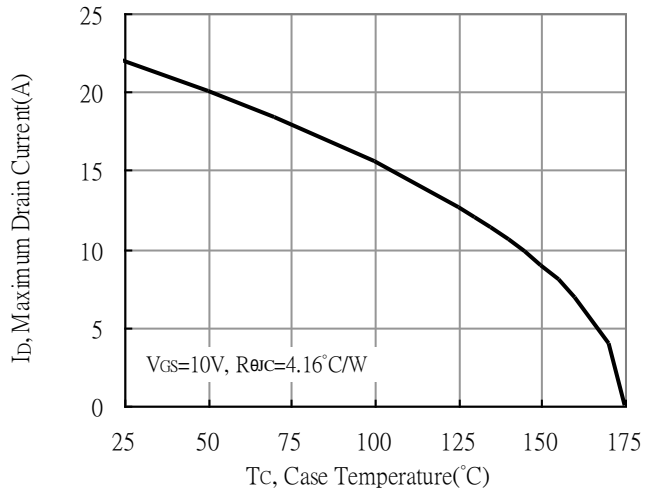

Typical Characteristics(Cont.)

Typical Transfer Characteristics

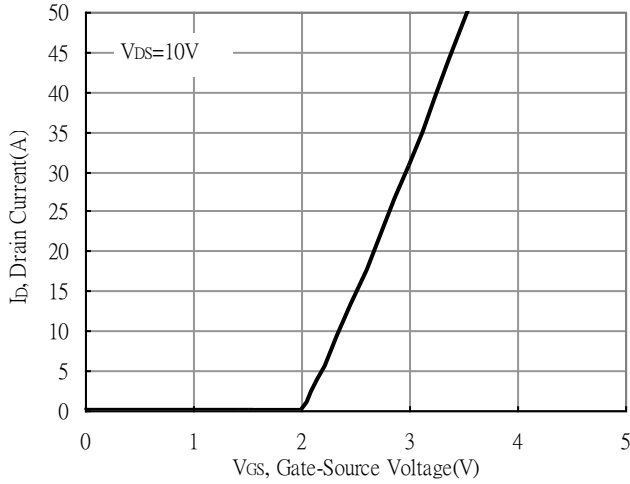

Single Pulse Maximum Power Rating

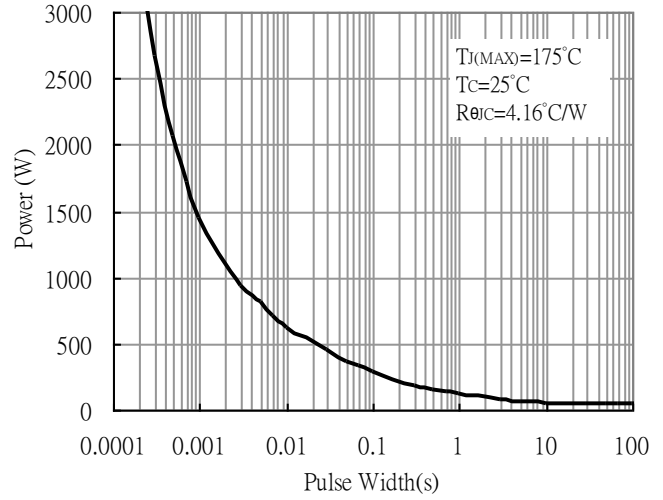

Transient Thermal Response Curves

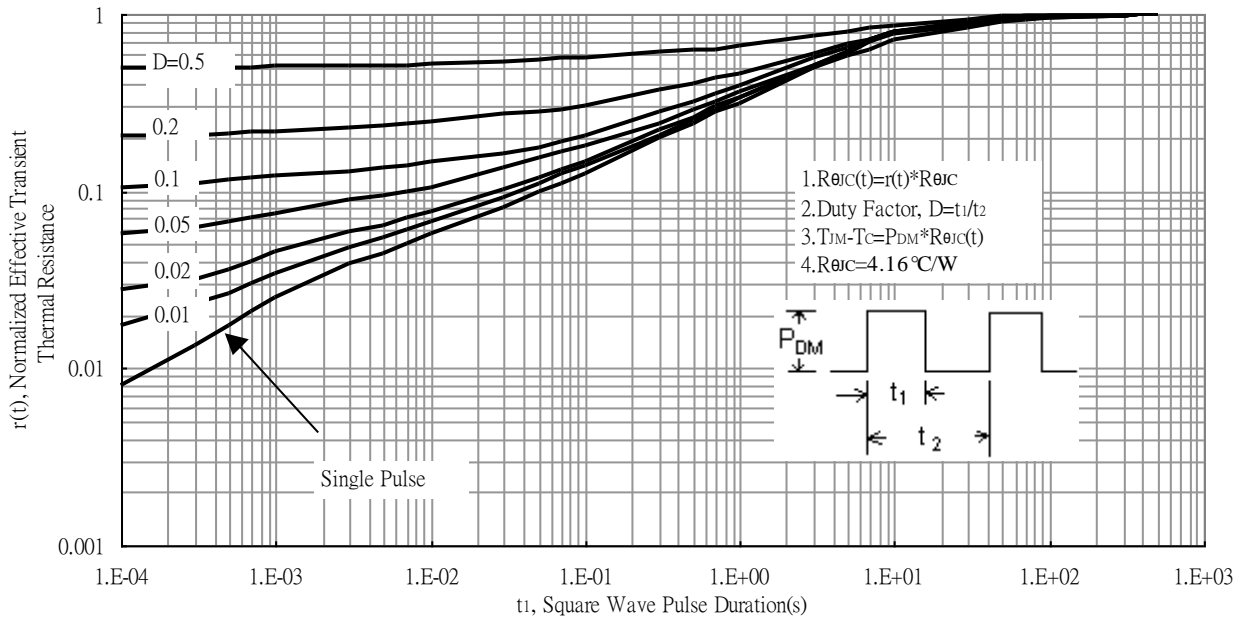

Recommended wave soldering condition

Product	Peak Temperature	Soldering Time
Pb-free devices	260 +0/-5 °C	5 +1/-1 seconds

Recommended temperature profile for IR reflow

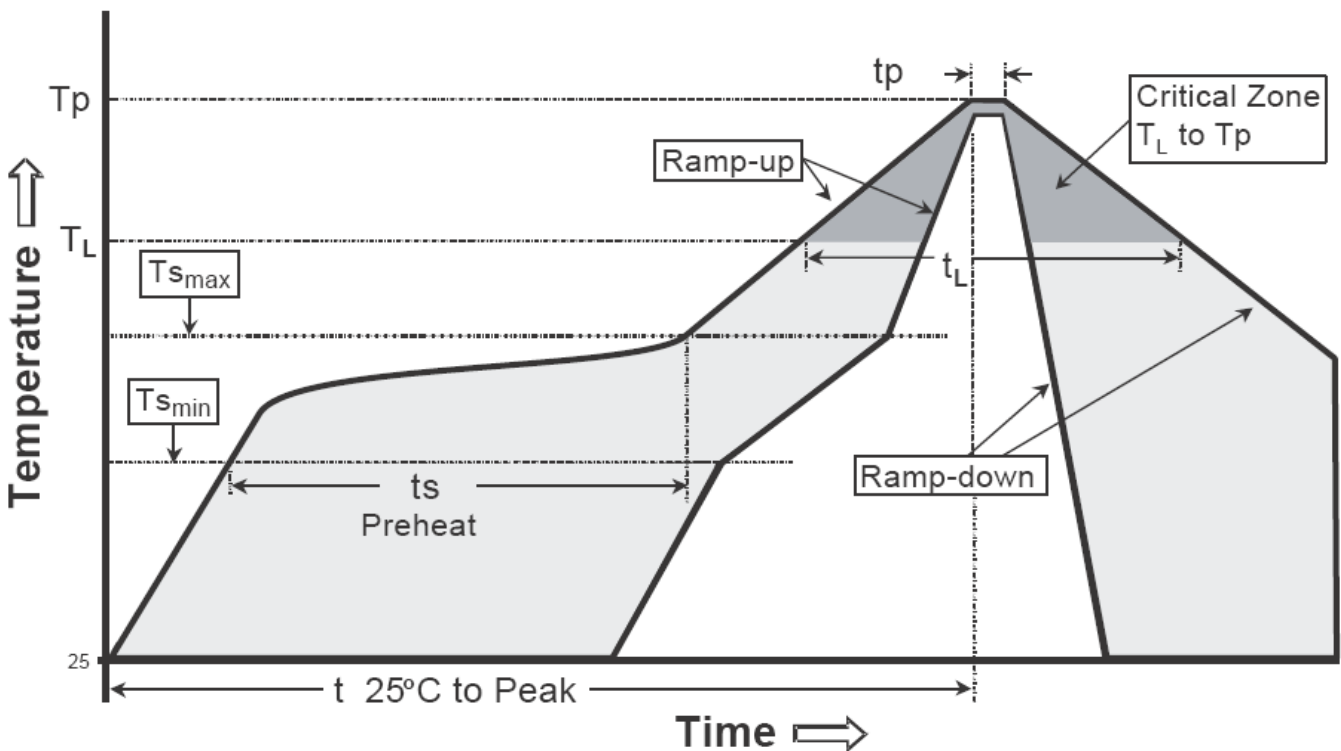

Profile feature	Sn-Pb eutectic Assembly	Pb-free Assembly
Average ramp-up rate (T _{smax} to T _p)	3°C/second max.	3°C/second max.
Preheat		
-Temperature Min(T _{s min})	100°C	150°C
-Temperature Max(T _{s max})	150°C	200°C
-Time(t _{s min} to t _{s max})	60-120 seconds	60-180 seconds
Time maintained above:		
-Temperature (T _L)	183°C	217°C
- Time (t _L)	60-150 seconds	60-150 seconds
Peak Temperature(T _P)	240 +0/-5 °C	260 +0/-5 °C
Time within 5°C of actual peak temperature(tp)	10-30 seconds	20-40 seconds
Ramp down rate	6°C/second max.	6°C/second max.
Time 25 °C to peak temperature	6 minutes max.	8 minutes max.

Note : All temperatures refer to topside of the package, measured on the package body surface.

TO-251 Dimension

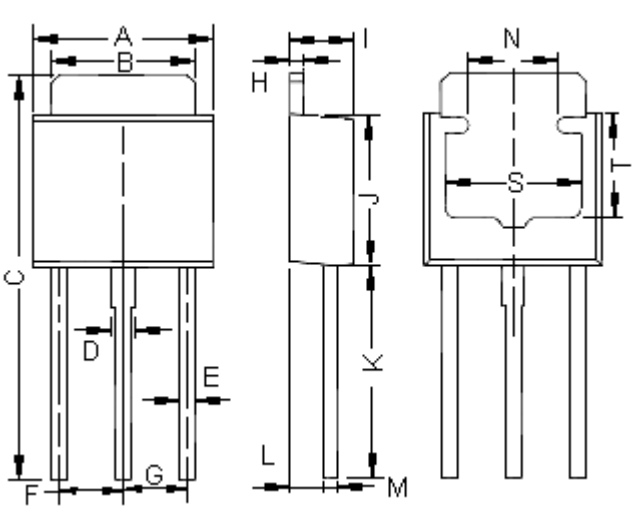

Marking:

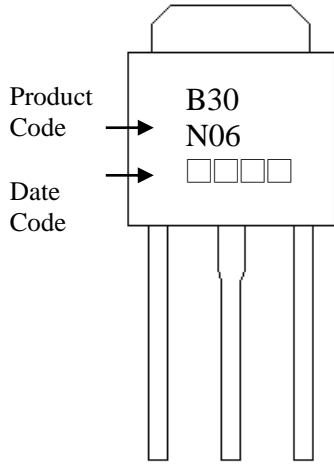

Product Code → B30
 N06
 Date Code → □□□□

Style: Pin 1.Gate 2.Drain 3.Source

3-Lead TO-251 Plastic Package
 CYStek Package Code: I3

DIM	Inches		Millimeters		DIM	Inches		Millimeters	
	Min.	Max.	Min.	Max.		Min.	Max.	Min.	Max.
A	0.2500	0.2618	6.35	6.65	I	0.0866	0.0945	2.20	2.40
B	0.2047	0.2126	5.20	5.40	J	0.2126	0.2244	5.40	5.70
C	0.5709	0.5866	14.50	14.90	K	0.2992	0.3071	7.60	7.80
D	0.0276	0.0354	0.70	0.90	L	0.0453	0.0492	1.15	1.25
E	0.0199	0.0276	0.50	0.70	M	0.0169	0.0228	0.43	0.58
F	0.0886	0.0925	2.25	2.35	N	0.1181	REF	3.00	REF
G	0.0886	0.0925	2.25	2.35	S	0.1969	REF	5.00	REF
H	0.0169	0.0228	0.43	0.58	T	0.1496	REF	3.80	REF

Notes: 1.Controlling dimension: millimeters.
 2.Maximum lead thickness includes lead finish thickness, and minimum lead thickness is the minimum thickness of base material.
 3.If there is any question with packing specification or packing method, please contact your local CYStek sales office.

Material:

- Lead: Pure tin plated
- Mold Compound: Epoxy resin family, flammability solid burning class: UL94V-0

Important Notice:

- All rights are reserved. Reproduction in whole or in part is prohibited without the prior written approval of CYStek.
- CYStek reserves the right to make changes to its products without notice.
- CYStek **semiconductor products are not warranted to be suitable for use in Life-Support Applications, or systems.**
- CYStek assumes no liability for any consequence of customer product design, infringement of patents, or application assistance.