

■ Features

- High Luminous LEDs
- 5mm Round Standard Directivity
- UV Resistant Epoxy
- Integral Current Limiting Resistor
- TTL Compatible (Requires No External Current Limiter With 12 Volt Supply)
- Cost Effective (Saves Space and Resistor Cost)
- Color Diffused Type

■ Applications

- Status Indicators
- Other Lighting

■ Outline Dimension

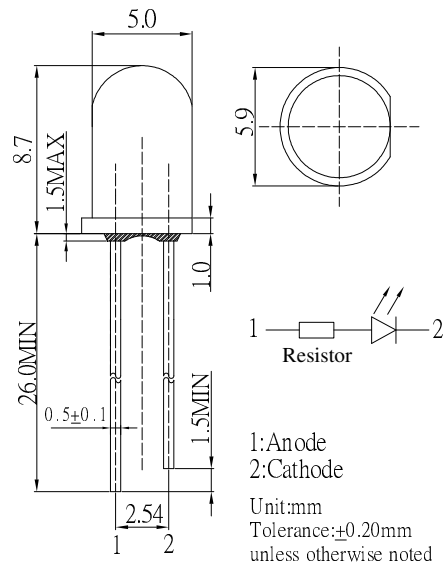

■ Absolute Maximum Rating

(Ta=25°C)

Item	Symbol	Value	Unit
DC Forward Voltage	V _F	15	V
Reverse Voltage	V _R	5	V
Power Dissipation	P _D	225	mW
Operating Temperature	T _{opr}	-30 ~ +85	°C
Storage Temperature	T _{stg}	-40~ +100	°C
Lead Soldering Temperature	T _{sol}	260°C/5sec	-

■ Directivity

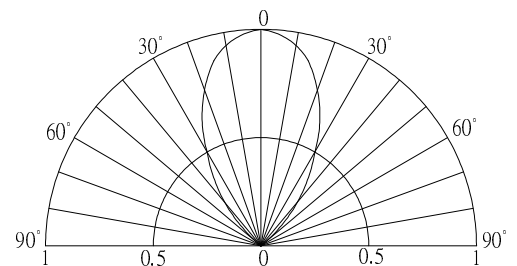

■ Electrical -Optical Characteristics

(Ta=25°C)

Item	Symbol	Condition	Min.	Typ.	Max.	Unit
DC Forward Current*1	I _F	V _F =12V	-	10	15	mA
DC Reverse Current	I _R	V _R =12V	-	-	10	μA
Domi. Wavelength*2	λ _D	V _F =12V	565	570	575	nm
Luminous Intensity*3	I _v	V _F =12V	68	90	-	mcd
50% Power Angle	2θ _{1/2}	V _F =12V	-	60	-	deg

*1 Tolerance of measurements of forward current is ±1mA

*2 Tolerance of measurements of dominant wavelength is ±1nm

*3 Tolerance of measurements of luminous intensity is ±15%

AlGaInP and Si Resistor LED

TYPICAL ELECTRICAL/OPTICAL CHARACTERISTIC CURVES

