

■ Features

- High Luminous LEDs
- 2.43x5.0x8.6mm Tombstone Standard Directivity
- UV Resistant Epoxy
- Water Clear Type

■ Applications

- Electronic Signs and Signals
- Small Area Illuminations
- Back Lighting
- Other Lighting

■ Outline Dimension

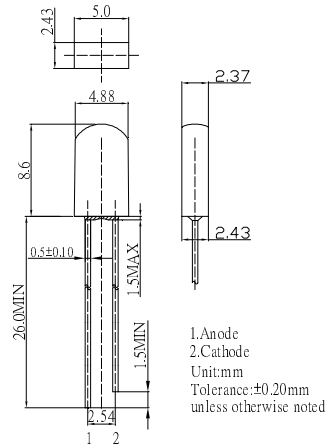

■ Absolute Maximum Rating

(Ta=25°C)

Item	Symbol	Value	Unit
DC Forward Current	I _F	30	mA
Pulse Forward Current#	I _{FP}	100	mA
Reverse Voltage	V _R	5	V
Power Dissipation	P _D	78	mW
Operating Temperature	T _{opr}	-30 ~ +85	°C
Storage Temperature	T _{stg}	-40 ~ +100	°C
Lead Soldering Temperature	T _{sol}	260°C/5sec	-

#Pulse width Max 0.1ms, Duty ratio max 1/10

■ Directivity

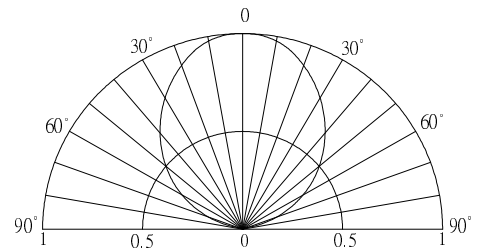

■ Electrical -Optical Characteristics

(Ta=25°C)

Item	Symbol	Condition	Min.	Typ.	Max.	Unit
DC Forward Voltage*1	V _F	I _F =20mA	1.8	2.1	2.6	V
DC Reverse Current	I _R	V _R =5V	-	-	10	μA
Domi. Wavelength*2	λ _D	I _F =20mA	620	625	630	nm
Luminous Intensity*3	I _v	I _F =20mA	330	500	-	mcd
50% Power Angle	2θ _{1/2}	I _F =20mA	-	100	-	deg

*1 Tolerance of measurements of forward voltage is ±0.1V

*2 Tolerance of measurements of dominant wavelength is ±1nm

*3 Tolerance of measurements of luminous intensity is ±15%

AlGaInP LED
TYPICAL ELECTRICAL/OPTICAL CHARACTERISTIC CURVES

