

FEATURES

- Guaranteed Output Current of 600mA
- Highly Output Accuracy: $\pm 1.5\%$
- Very Low Quiescent Current
- Very Low Dropout Voltage
- Excellent Line and Load Regulation
- Fixed Output Voltage: 1.2V, 1.8V, 2.5V, and 3.3V
- Adjustable Output Voltage: 1.27V to 6.0V
- Logic Controlled Shutdown Option
- Stable with Low ESR MLCC
- Over Current Protection
- Over Temperature Protection
- Available in SOT-23-5L Package

APPLICATIONS

- Mobile Phones and Smart Phones
- Digital Cameras and Camcorders
- Portable Communication Devices
- GPS, PDAs and handhelds
- Battery-Powered Devices

DESCRIPTION

The TPS740xx is a series of 600mA high performance low dropout linear voltage regulator ideal for mobile or portable applications with high output voltage accuracy, very low quiescent current, and very low dropout voltage.

The series are available with fixed output voltages between 1.2V to 3.3V and adjustable output voltage from 1.27V to 6.0V.

The TPS740xx include enable function to save power and it is stable with 1.0 μF MLCC.

The TPS740xx series are available in a SOT-23-5L package which are ideal for high density form factor portable equipment.

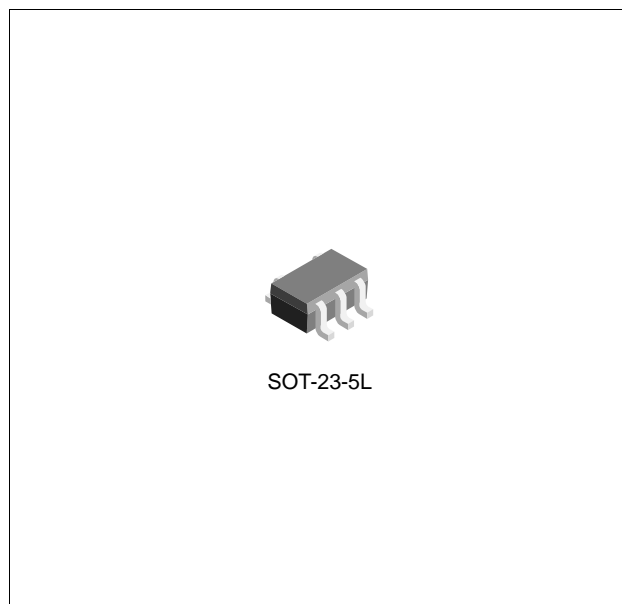

ORDERING INFORMATION

Device	Package
TPS740xxSF5	SOT-23-5L

xx: Output Voltage

ABSOLUTE MAXIMUM RATINGS (Note 1)

CHARACTERISTIC	SYMBOL	MIN	MAX	UNIT
Input Supply Voltage (Survival)	V_{IN}	-0.3	8.0	V
Enable Input Voltage (Survival)	V_{EN}	-0.3	$V_{IN} + 0.3$	V
Output Voltage (Survival)	V_{OUT}	-0.3	$V_{IN} + 0.3$	V
Maximum Output Current	I_{MAX}	-	1.0	A
Operating Ambient Temperature Range	T_{AOPR}	-40	125	°C
Storage Temperature Range	T_{STG}	-65	150	°C
Package Thermal Resistance*	$\Theta_{JA-SOT-23-5}$	265		°C/W
	$\Theta_{JC-SOT-23-5}$	130		°C/W

* Calculated from package in still air, mounted to minimum foot print 2 layer PCB without thermal via per JE51 standards.

RECOMMENDED OPERATING RATINGS (Note 2)

CHARACTERISTIC	SYMBOL	MIN	MAX	UNIT
Input Supply Voltage	V_{IN}	0	6.5	V
Enable Input Voltage	V_{EN}	0	V_{IN}	V
Maximum Output Current	I_{MAX}	-	600	mA

ORDERING INFORMATION

VOUT	Package	Order No.	Description	Supplied As	Status
ADJ	SOT-23-5L	TPS74001SF5	Enable, Adjustable	Tape & Reel	Contact Us
1.2V	SOT-23-5L	TPS74012SF5	Enable	Tape & Reel	Contact Us
1.8V	SOT-23-5L	TPS74018SF5	Enable	Tape & Reel	Contact Us
2.5V	SOT-23-5L	TPS74025SF5	Enable	Tape & Reel	Contact Us
3.3V	SOT-23-5L	TPS74033SF5	Enable	Tape & Reel	Active

PIN CONFIGURATION

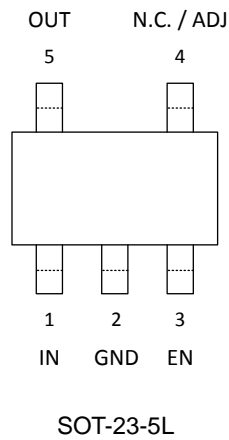

PIN DESCRIPTION

Pin No.	Pin Name	Pin Function
1	IN	Input Voltage.
2	GND	Ground.
3	EN	Enable Voltage. Do Not Float.
4	N.C.	No Connection for Fixed Output Version.
	ADJ	Output Voltage Adjustable Input for Adjustable Output Version. Connect an external voltage divider to determine the output voltage.
5	OUT	Output Voltage.

TYPICAL APPLICATION CIRCUIT

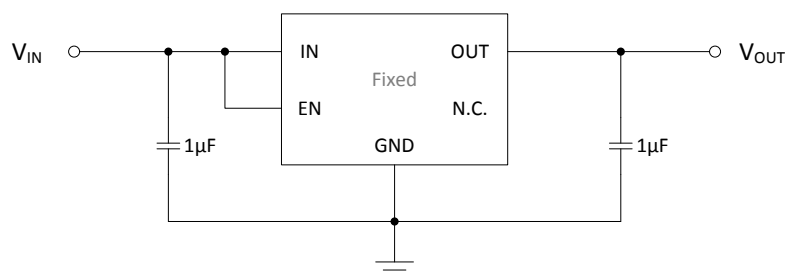
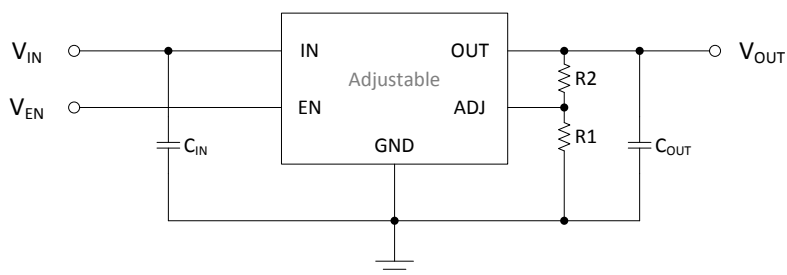
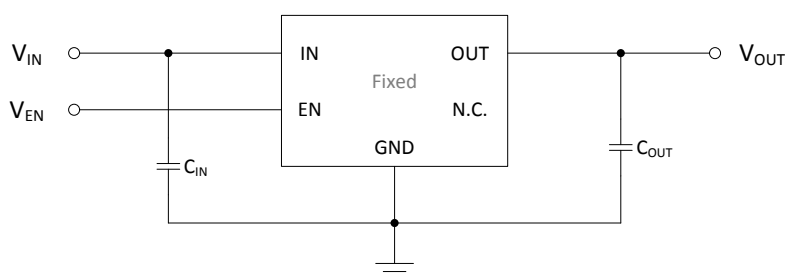
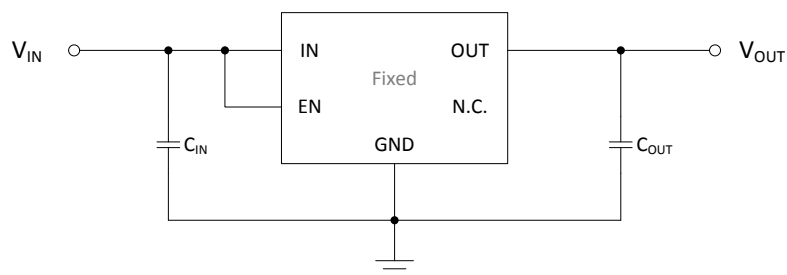

* For the details, see Application Information.

** TPS740xx can deliver a continuous current of 600 mA over the full operating temperature. However, the output current is limited by the restriction of power dissipation which differs from packages. A heat sink may be required depending on the maximum power dissipation and maximum ambient temperature of application. With respect to the applied package, the maximum output current of 600 mA may be still undeliverable.

ELECTRICAL CHARACTERISTICS

Limits in standard typeface are for $T_J = 25^\circ\text{C}$, $V_{IN} = V_{OUT(NOM)} + 1.0\text{ V}$ or $V_{IN} = 2.5\text{ V}$, whichever is greater; $V_{EN} = V_{IN}$, $I_{OUT} = 1\text{ mA}$, $C_{IN} = C_{OUT} = 1.0\ \mu\text{F}$, unless otherwise specified.

PARAMETER	SYMBOL	TEST CONDITIONS	MIN	TYP	MAX	UNIT	
Output Voltage Accuracy	V_{OUT}	$I_{OUT} = 1.0\text{ mA}$	-1.5	-	1.5	%	
		$I_{OUT} = 1.0\text{ mA to }600\text{ mA}$	-3	-	2	%	
Adjustable Voltage	V_{ADJ}	$I_{OUT} = 1.0\text{ mA}$	1.251	1.27	1.289	V	
		$I_{OUT} = 1.0\text{ mA to }600\text{ mA}$	1.232	1.27	1.295	V	
Line Regulation	LNR	$(V_{OUT} + 1.0\text{ V}) < V_{IN} < 6.5\text{ V}$	-	0.05	0.3	%/V	
Load Regulation ^(Note 3)	LDR	$1.0\text{ mA} \leq I_{OUT} \leq 600\text{ mA}$	-	0.5	1.5	%	
Dropout Voltage	V_{DROP}	$I_{OUT} = 300\text{ mA}$	$V_{OUT} > 2.8\text{ V}$	-	300	500	mV
			$2.0\text{ V} < V_{OUT} \leq 2.8\text{ V}$	-	450	700	
			$V_{OUT} \leq 2.0\text{ V}$	-	650	950	
		$I_{OUT} = 600\text{ mA}$	$V_{OUT} > 2.8\text{ V}$	-	600	1000	
			$2.0\text{ V} < V_{OUT} \leq 2.8\text{ V}$	-	900	1400	
			$V_{OUT} \leq 2.0\text{ V}$	-	1300	1900	
Maximum Output Current	$I_{O(MAX)}$	$V_{OUT} > 0.96 \times V_{OUT(NOM)}$	600	-	-	mA	
Current Limit	I_{CL}		-	1300	-	mA	
Ground Current	I_{GND}	$I_{OUT} = 0\text{ mA to }600\text{ mA}$	-	50	85	μA	
Shutdown Current	I_{SD}	$V_{EN} = 0\text{ V}$	-	0.01	1.0	μA	
EN Threshold Logic Low	V_{ENL}	$V_{IN} = 2.5\text{ V to }5.5\text{ V}$	-	-	0.4	V	
EN Threshold Logic High	V_{ENH}	$V_{IN} = 2.5\text{ V to }5.5\text{ V}$	2.0	-	-	V	
EN Input Bias Current	I_{ENH}	$V_{EN} = V_{IN}$	-	-	100	nA	
EN Input Low Current	I_{ENL}	$V_{EN} = 0\text{ V}$	-1.0	-0.3	-	μA	
EN Exit Delay		$I_{OUT} = 100\text{ mA}$	-	600	-	μsec	
Thermal Shutdown Temperature	T_{SD}	$I_{OUT} = 10\text{ mA}$	-	155	-	$^\circ\text{C}$	
Thermal Shutdown Hysteresis	ΔT_{SD}	$I_{OUT} = 10\text{ mA}$	-	10	-	$^\circ\text{C}$	
V_{OUT} Temperature Coefficient		$I_{OUT} = 10\text{ mA}$	-	30	-	ppm	
Power Supply Ripple Rejection	PSRR	$I_{OUT} = 100\text{ mA}$, $C_{OUT} = 2.2\ \mu\text{F}$, $f = 100\text{ Hz}$	-	55	-	dB	

Note 1. Exceeding the absolute maximum ratings may damage the device.

Note 2. The device is not guaranteed to function outside its operating ratings.

Note 3. Regulation is measured at constant junction temperature by using a 10ms current pulse.

TYPICAL OPERATING CHARACTERISTICS

$V_{OUT} = 2.5V$ ($C_{IN} = C_{OUT} = 10\mu F$, $R_2 = 36k\Omega$, $R_1 = 35k\Omega$)

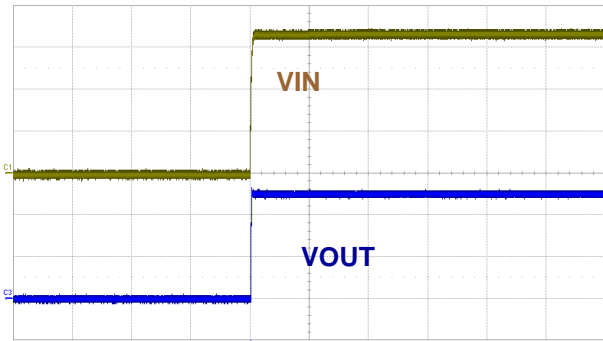

VIN: 1.0V/div, VOUT: 1.0V/div, Time: 10ms/div
 VIN=3.3V, VOUT=2.5V
 Start Up @ $I_{OUT}=0.3A$

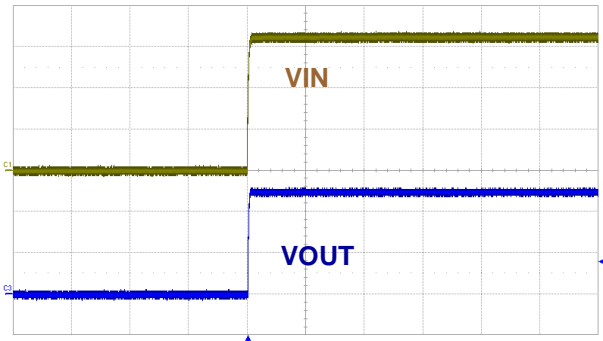

VIN: 1.0V/div, VOUT: 1.0V/div, Time: 10ms/div
 VIN=3.3V, VOUT=2.5V
 Start Up @ $I_{OUT}=0.6A$

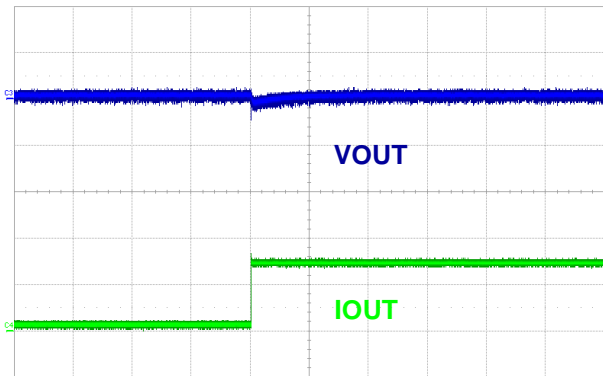

VOUT: 50mV/div, IOUT: 0.2A/div, Time: 50ms/div
 VIN=3.3V, VOUT=2.5V
 Load Transient Response

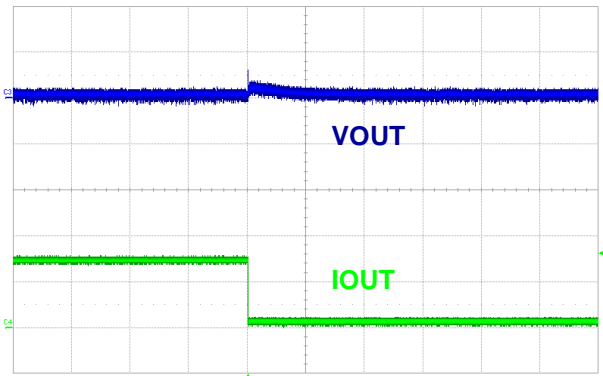

VOUT: 50mV/div, IOUT: 0.2A/div, Time: 50ms/div
 VIN=3.3V, VOUT=2.5V
 Load Transient Response

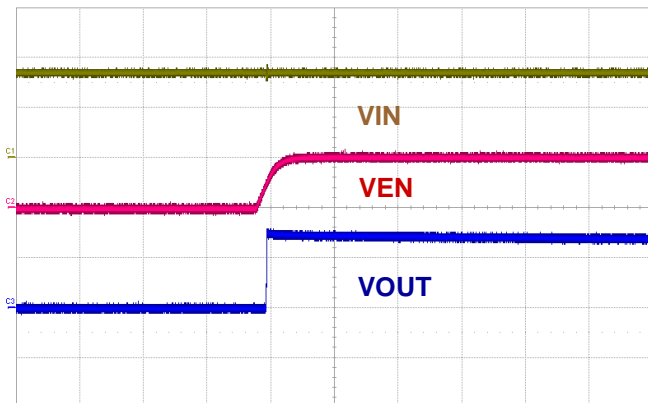

VIN: 2.0V/div, VEN: 2.0V, VOUT: 2.0V/div, Time: 1ms/div
 VIN=3.3V, VOUT=2.5V
 Start Up by External VEN @ $I_{OUT}=0A$

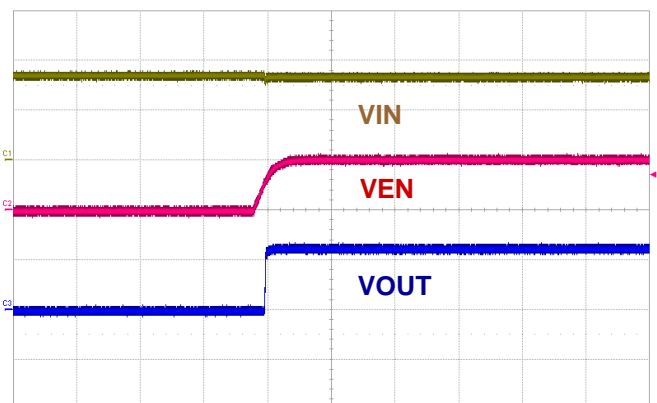

VIN: 2.0V/div, VEN: 2.0V, VOUT: 2.0V/div, Time: 1ms/div
 VIN=3.3V, VOUT=2.5V
 Start Up by External VEN @ $I_{OUT}=0.6A$

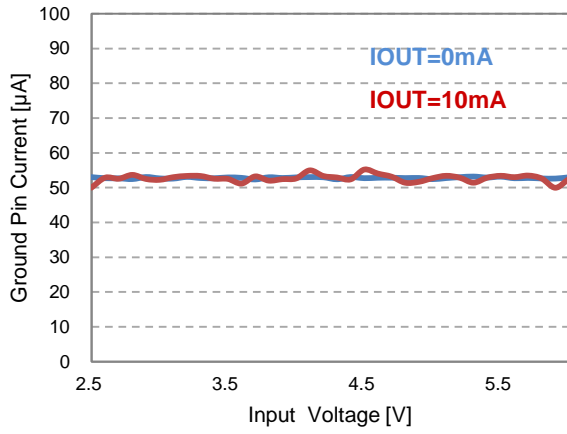

Ground Pin Current

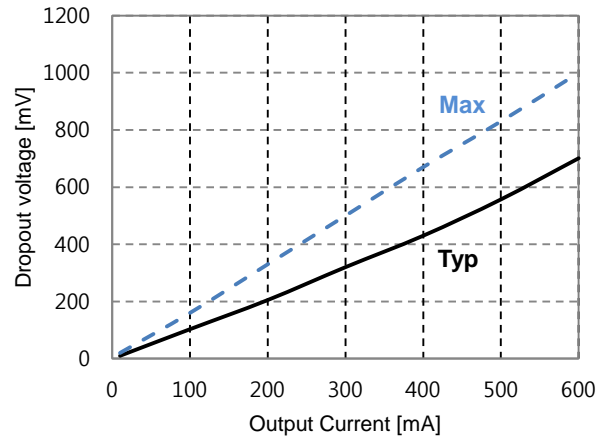

Dropout Voltage @ $V_{OUT}=3.3V$

APPLICATION INFORMATION

The TPS740xx consists of a high-precision voltage reference, an error correction circuit, and a current limited output driver. With good transient responses, output remains stable even during load changes. The EN input enables the output to be turned off, resulting in reduced power consumption. The TPS740xx incorporates both over-temperature and over-current protection.

INPUT CAPACITOR

An input capacitor of minimum 1.0 μF of MLCC is recommended. Larger values will help to improve ripple rejection by bypassing the input to the regulator, further improving the integrity of the output voltage. X7R or X5R dielectrics are recommended and it should be placed as close as to the IN pin as possible.

OUTPUT CAPACITOR

The TPS740xx requires a minimum output capacitance maintain stability. The TPS740xx is designed to be stable with a MLCC with very low equivalent series resistance (ESR). A 1.0 μF of MLCC would satisfy most applications. Larger values and lower ESR improves dynamic performance. X7R or X5R dielectrics are recommended to maintain sufficient capacitance over its full operating temperature. It should be placed as close as OUT pin as possible.

OUTPUT ADJUSTMENT

The operating condition of V_{IN} and the operating characteristics of V_{OUT} depend on the dropout voltage performance in accordance with output load current.

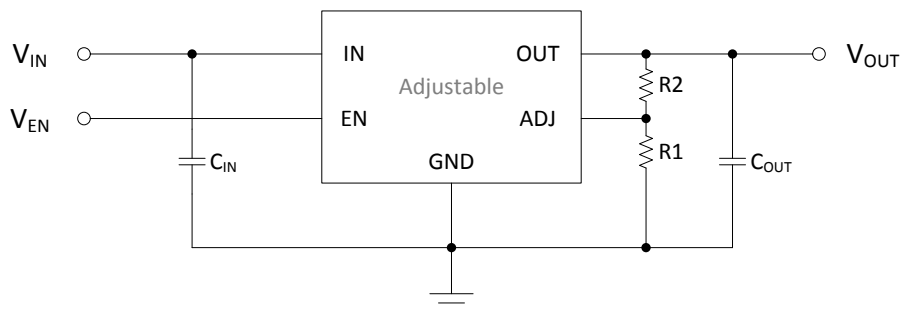

$$V_{\text{OUT}} = V_{\text{ADJ}} (1 + R2 / R1)$$

MAXIMUM OUPUT CURRENT CAPABILITY

The TPS740xx can deliver a continuous current of 600mA over the full operating junction temperature range. However, the output current is limited by the restriction of power dissipation of package. With respect to the applied package, the maximum output current of 300mA may be still undeliverable due to the restriction of the power dissipation of TPS740xx. Under all possible conditions, the junction temperature must be within the range specified under operating conditions.

The temperatures over the device are given by:

$$T_{\text{C}} = T_{\text{A}} + P_{\text{D}} \times \theta_{\text{CA}}$$

$$T_{\text{J}} = T_{\text{C}} + P_{\text{D}} \times \theta_{\text{JC}}$$

$$T_J = T_A + P_D \times \theta_{JA}$$

where T_J is the junction temperature, T_C is the case temperature, T_A is the ambient temperature, P_D is the total power dissipation of the device, θ_{CA} is the thermal resistance of case-to-ambient, θ_{JC} is the thermal resistance of junction-to-case, and θ_{JA} is the thermal resistance of junction to ambient.

The total power dissipation of the device is given by:

$$\begin{aligned} P_D &= P_{IN} - P_{OUT} = (V_{IN} \times I_{IN}) - (V_{OUT} \times I_{OUT}) \\ &= (V_{IN} \times (I_{OUT} + I_{GND})) - (V_{OUT} \times I_{OUT}) = (V_{IN} - V_{OUT}) \times I_{OUT} + V_{IN} \times I_{GND} \end{aligned}$$

where I_{GND} is the operating ground current of the device which is specified at the Electrical Characteristics. The maximum allowable temperature rise (T_{Rmax}) depends on the maximum ambient temperature (T_{Amax}) of the application, and the maximum allowable junction temperature (T_{Jmax}):

$$T_{Rmax} = T_{Jmax} - T_{Amax}$$

The maximum allowable value for junction-to-ambient thermal resistance, θ_{JA} , can be calculated using the formula:

$$\theta_{JA} = T_{Rmax} / P_D$$

If proper cooling solution such as copper plane area or air flow is applied, the maximum allowable power dissipation could be increased. However, if the ambient temperature is increased, the allowable power dissipation would be decreased.

REVISION NOTICE

The description in this datasheet is subject to change without any notice to describe its electrical characteristics properly.