

DSO112A Digital Oscilloscope

User Manual

Applicable Models: 11201A, 11202A, 11203A

Applicable Firmware Version: 113-11201-211 or later (for U1)

Before First Time Use	3
Introduction	3
Packing Contents	3
Switch on Battery	3
Charge Battery	4
Auto Power-off	4
Panel and Connectors	4
Main Working Screen	4
Connectors	5
Power Button	6
Basic Operations	6
Power On/Off	6
Probe a Signal	6
State Navigation	7
Booting Sequence	7
Adjust Sensitivity and Couple	8
Adjust Timebase	8
Setup Trigger	8
External Trigger	10
Trigger Level	10
Adjust Vertical Position	10
Adjust Horizontal Position	10
Hold State	10
Select Record Length	10
Test Signal Output	10
Advanced Operations	11
VPos Alignment	11
Save Waveform	11
Recall Waveform	11
Send Waveform Data	12
Restore Factory Default	15
Save/Recall Presets	15
Rename Presets	16
Enter Dashboard	16
Select Test Signal Frequency	16
ΔT Cursors	17
ΔV Cursors	17
Frequency Measurement	17
Voltage Measurements	17
Change Auto-off Time	17
Serial Interface (SI)	18
Introduction	18
Output of Captured Data	19
Output of Measurements	20
Commands and Their Returns	21
CSV Waveform File Format	27
Use as Integration Module	29
Connectors	29
Dimensions	30
Maintenance	31
Charge Battery	31

Touch Panel Calibration.....	31
Firmware Upgrade.....	32
Troubleshooting	35
Oscilloscope Does Not Turn On	35
White Screen	35
Touch Panel No Reaction	35
Specifications	35
Appendix A: Coded Values of Oscilloscope Parameters.....	36
1) Values of Timebase	36
2) Values of Trigger Mode	36
3) Values of Trigger Slope.....	36
4) Values of Couple.....	37
5) Values of Vertical Sensitivity	37
Revision History	37

Before First Time Use

Introduction

DSO112A is based on DSO112 with re-designed schematic and PCB. While keeping all functions and performance of its predecessor it exhibits significantly higher vertical sensitivity and ultra low background noises. As a small, light, accurate, and battery operated oscilloscope DSO112A is best for portable or field use.

Packing Contents

Check packing contents based on sku number and the following table.

	11201A	11202A
DSO112A Oscilloscope	1	1
MCX-Clip Probe	2	2
USB Cable	1	1
Battery	1	

Switch on Battery

For transportation safety the battery was disconnected by a switch prior to shipping. This switch must be turned on before the battery can be used. The switch locates inside the enclosure close to the top-left corner (see the next two photos). It can be turned on by slide it towards the USB connector with a small stick through the slot at top-left corner of the enclosure. Please refer to the photo below.



Charge Battery

The battery in new oscilloscope is usually depleted or has only weak power. It is necessary to have it charged before first time use. To charge the battery you need to connect the device to a USB power with the provided USB cable. Before connecting USB cable remember to close the battery switch as state above. A LED on PCB board will light up when charge is undergoing (photo below). The LED can be seen from outside of enclosure. After charge is completed the LED will turn off.

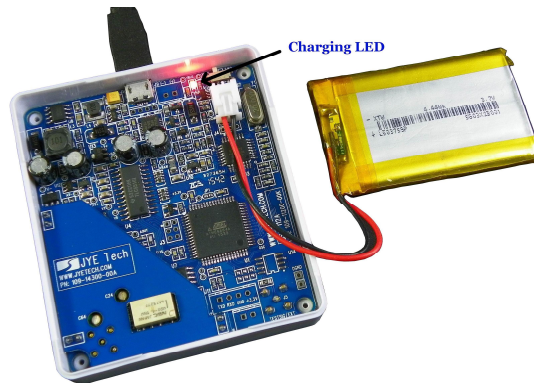

Auto Power-off

To avoid waste of battery power DSO112A is with automatic shut-down feature. When the unit is running on battery and there is no touch activity detected for a certain period of time the oscilloscope will shut down itself. This auto-power-off time is set to **2 minutes** by default. You may like to change it to longer to avoid un-wanted quick shut down. Please see description of “Change Auto-off Time” section.

Panel and Connectors

Main Working Screen

The drawing below explains the major display elements of the main working screen.

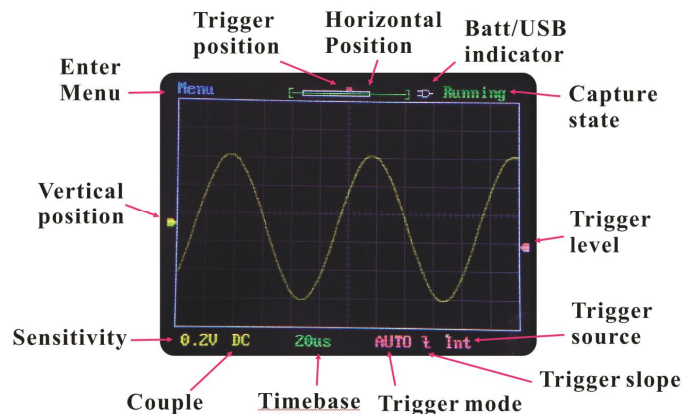

Most elements are self-explained in the figure. The following are some further explanations for some elements.

Vertical Position Indicator

Indicating the 0V signal level.

Horizontal Position Indicator

This consists of a green bracket and a white rectangle inside the bracket. The green bracket represents capture buffer size and the white rectangle represents the viewed portion of capture buffer.

Trigger Level Indicator

Indicating trigger level with reference to signal level.

Trigger Position Indicator

Indicating trigger position inside capture buffer which is represented by the green brackets.

Connectors

The following figure shows the functions and types of DSO112A connectors. Please note that the Test Signal Output connector is dual functional. It becomes external trigger input when external trigger is selected. The test signal output is disabled accordingly. Test signal output will restore when external trigger is deselected.

Maximum Voltage Range

The maximum input signal voltage is 50Vpk.

The maximum external trigger voltage is 15Vpk.

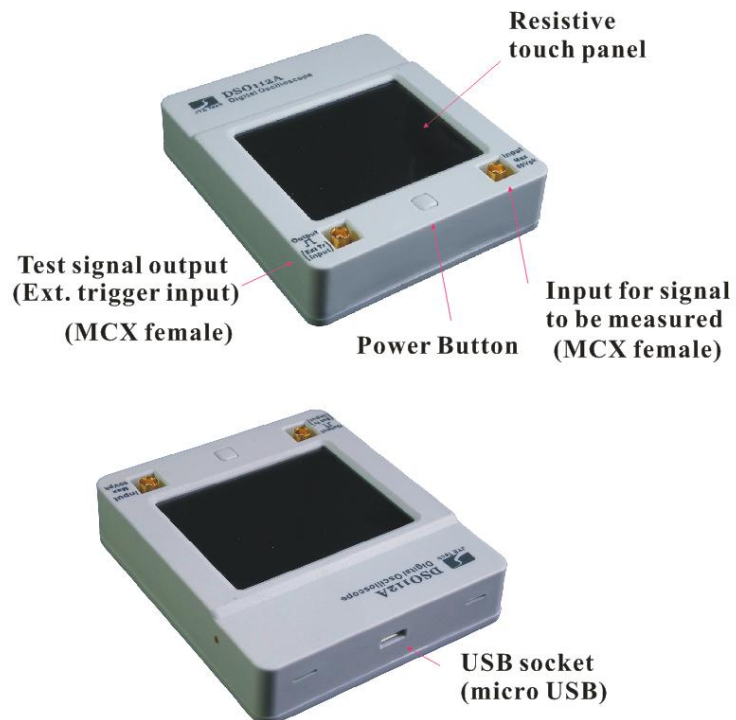

Power Button

The Power Button is multi-functional.

- Ø When oscilloscope is off short press of power button will turn the device on if battery or USB power has been connected.
- Ø Under any state press and hold this button for 3 seconds will bring up power-off dialog box, in which you can select to power off or not.
- Ø At the power-up screen where firmware versions are shown press this button will make the device enter **Setup State** where Factory Default Restore and Touch Panel Calibration can be performed.
- Ø Under any state holding down power button for more than 15 seconds will force the oscilloscope shut down.

Basic Operations

Power On/Off

To Power On

Press the Power Button when battery or USB power has been connected.

To Power Off

DSO112A can be powered off in three ways:

- Ø In the main working screen touch the “Menu” button at top-left corner and select “Pwr Off” button.
- Ø Under any state press and hold power button for 3 seconds to bring up power-off dialog box. Then choose “Yes” or hold the power button again for 3 seconds. The later is useful when touch panel is not working.
- Ø Under any state continuously hold the power button for 15 seconds will force the device power off.

Probe a Signal

Once the oscilloscope enters normal working state where the main working screen is shown you are ready to probe signals.

To probe a signal plug one of the MCX-Clip probe to the signal input connector. Connect the black clip to the reference point (usually called GROUND) of the circuit you want to probe. Connect the red clip to the signal of interest.

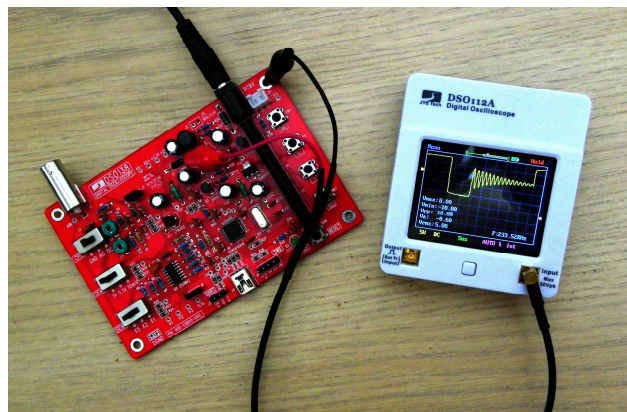

State Navigation

The following diagram shows the relationship of major working states.

Tip: DSO112A uses resistive LCD panel. It will have better effects to operate with fingernail instead of finger belly as in operating a cellular phone.

4. Use the Scope

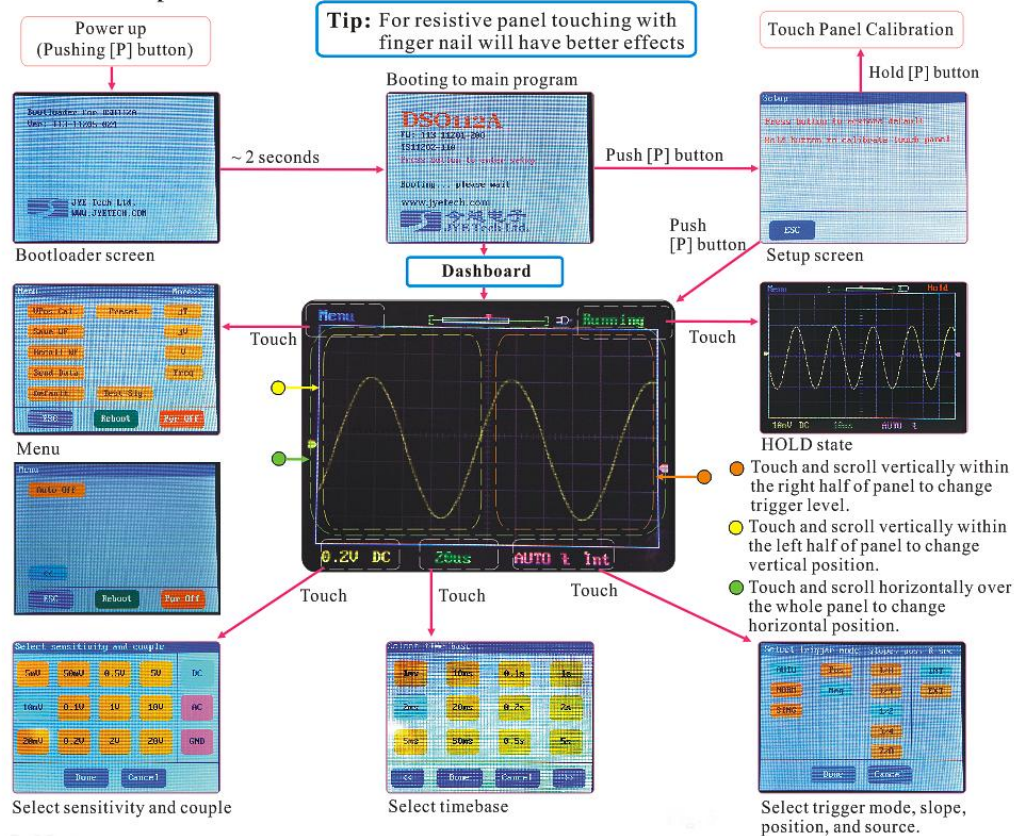

Booting Sequence

When power button is pressed the oscilloscope is powered up. The main controller (MCU) will first enter the Bootloader, where it waits about 2 seconds for possible firmware upgrade request from serial (USB) port. If such request is received MCU will stay in Bootloader to perform firmware upgrade. If no request is received the MCU will boot into the main firmware of the oscilloscope.

The main firmware will first display the start-up screen at which information about firmware and manufacturer is shown. This screen will stay for about 2 seconds. During this time if the power button is pressed the unit will enter Setup State, where you can choose to do factory default restore or touch panel calibration. If power button has not been pressed during that time MCU will then display the **dashboard**, at which user can quickly put the oscilloscope into pre-saved setup. The dashboard will stay for about 8 seconds. After that the oscilloscope will enter normal state with the main working screen displayed. You can start normal use of the oscilloscope now.

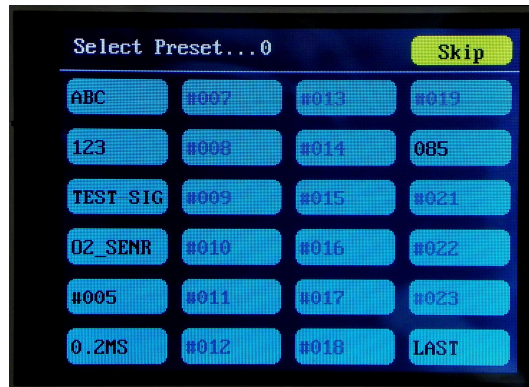

Adjust Sensitivity and Couple

To adjust sensitivity or couple touch the lower-left corner of screen where current sensitivity and couple settings are shown. This will bring up “Select Sensitivity and Couple” screen. Touch the sensitivity and couple settings you want and then touch the “Done” button. The new selections will take effect immediately and oscilloscope is back to normal working state. If the sensitivity setting you need is not displayed use “<<” and “>>” buttons to navigate.

Adjust Timebase

To adjust timebase touch the area where current timebase is displayed. This will bring up “Select Timebase” screen. Select the timebase you want and touch “Done” button to go back to normal working state. The new timebase setting will take effect immediately. If the timebase setting you need is not displayed use “<<” and “>>” buttons to navigate.

Setup Trigger

To setup trigger touch the area where current trigger mode and trigger slope settings are shown. This will bring up “Select Trigger mode, slope, pos, and src” screen. Select the settings you need by touching the corresponding buttons. Touch “Done” button to finish. New settings will take effect immediately and the scope is back to normal working state.

Trigger Modes

Ø **AUTO** Under this mode the oscilloscope will perform capturing regardless trigger is valid or not. When trigger is valid the waveform display will synchronize to trigger and be stable. When trigger is not valid the oscilloscope will display captured waveform randomly and waveform display may be unstable. Under this mode you will always be able to see display refreshes regardless trigger.

Ø **NORM** This is called NORMAL mode. Under this mode the oscilloscope will perform capture and update display when and only when trigger is valid. As result, the waveform display will appear frozen if no trigger is valid. You need to adjust signal or oscilloscope parameters to make trigger happen in order to see waveform refresh. This mode is useful for capturing sparse signals. The temporary frozen effect makes sparse waveform stay on screen instead of just flash across.

Ø **SING** This is called SINGLE mode. It works very much the same as NORMAL mode. The only different is that once a valid trigger is detected the oscilloscope performs capture and updates display. It then enters HOLD state and stops further capture. It will stay in HOLD state until be released manually. This mode is usually used to capture non-repeat signals.

Note: Trigger is ignored when timebase is set to 5us/Div or faster. This is because MCU is too busy to handle trigger at these timebase settings.

Trigger Slope

Trigger slope is the signal slope that is chosen to compare with trigger level. When the selected signal slope intersects with trigger level a valid trigger is detected. The moment when the intersection happens is used as reference point for waveform display.

Trigger slope can be selected as rising, where signal is from low to high (also known as Positive), or falling, where signal is from high to low (also known as Negative).

Trigger Position

Trigger position is a reference point in capture buffer that you choose to align it with trigger moments. If trigger position is selected to close the start of capture buffer you will see more waveform after trigger. Vice versa, you will see more waveform before trigger. For DSO112A trigger position can be chosen to 1/8, 1/4, 1/2, 3/4, or 7/8 of capture buffer.

Trigger Source

Trigger source is the signal that is chosen to compare with trigger level. For DSO112A trigger source can be internal, i.e. the signal from scope input connector, or external, which is signal from the test signal connector.

External Trigger	External trigger means using a different signal as trigger signal. It is useful in situations where you want oscilloscope captures be synchronized by a specific signal. To use external trigger you need feed the synchronous signal into the test signal connector of DSO112A and select “Ext” at trigger setup screen. Please note that the maximum allowed voltage for external trigger signal is 0 – 15V.
Trigger Level	Trigger level is a DC level that is used to compare with trigger signal to detect intersections. It is indicated by a pink triangle at screen right border. Trigger level can be adjusted by touching anywhere in the right half screen and scroll vertically. To produce valid trigger the level needs to fall inside the range between maximum and minimum signal amplitude.
Adjust Vertical Position	To adjust vertical position touch anywhere in the left half screen and scroll vertically.
Adjust Horizontal Position	To adjust horizontal position touch anywhere of the screen and scroll horizontally.
Hold State	<p>Capture can be temporarily stopped by putting it in HOLD state. Once in HOLD state the screen refresh will be stopped and the last captured waveform will remain on display which can be view without rush.</p> <p>To enter HOLD state (i.e. frozen a waveform) touch the top-right corner of screen where a green “Running” is shown. Alternatively, press the power button will also enter HOLD state. In HOLD state the green “Running” will turn into a red “Stop”.</p> <p>To exit HOLD state touch the top-right corner (or press power button) again.</p> <p>When trigger mode is set to SING HOLD state will be entered automatically if valid trigger is detected.</p>
Select Record Length	For DSO112A record length can be set to 512 or 1024 points. To change record length enter “Select Timebase” screen as stated in “Adjust Timebase” section and use “>>” button to navigate to the end page. Select wanted record length and touch “Done” to finish.
Test Signal Output	<p>The test signal of DSO112A is for probe checking and calibration purpose. It is not a general signal source. The nominal amplitude of the test signal is 3.3V with 5% tolerance. The output impedance is 1K ohm. Test signal frequency can selected from several preset values (see instructions below).</p> <p>Once external trigger is selected the test signal output will be disabled automatically. It restores as soon as internal trigger is chosen.</p>

Advanced Operations

- VPos Alignment** Sometimes the vertical position indicator at screen left border is not aligned with 0V level trace. This can be fixed by performing VPos Alignment. To do this touch “Menu” at top-left screen corner to bring up menu page and select the button “VPos Cal”.
- Save Waveform** Captured waveform can be saved to in-chip EEPROM so as it is retained after power down and can be recalled at a later time for reviewing. To do this enter Menu and touch the button “Save WF”. The most recently captured and displayed waveform before entering Menu will be saved. The associated scope parameters are also saved at the same time.
- In order to make sure the right waveform is saved it is suggested to hold a waveform before saving it.
- Please note that saving a waveform will overwrite the data already in EEPROM without warning. That is to say, the previously saved waveform will be lost when a new waveform is saved.
- Recall Waveform** Saved waveform can be recalled and displayed on screen without any change. To do this enter Menu and touch the button “Recall WF”. Recalled waveform is always displayed in HOLD state.

Send Waveform Data

Waveform data can be transferred through the serial port to a different device (usually a PC) as CSV file for storage or further processing. In order to complete the transfer you need:

- Ø A correctly setup serial connection, and
- Ø A piece of communication software that runs on PC and supports XModem protocol. We will use Tera Term here as demonstration.

These are the steps to perform waveform data transfer.

Setup Serial Connections

- 1) Connect DSO112A oscilloscope to an USB port on PC.
- 2) DSO112A contains a Uart-USB bridge CP2102. You need install driver on the PC for this chip if you are the first time using the PC for DSO112A. Please go to Silicone Lab website www.silabs.com to download the appropriate driver for your system and install it correctly.
- 3) Install communication software. Here we use Tera Term as example. Tera Term is for Windows only. For other OS you need to install similar software. Tera Term can be downloaded at <http://www.jyotech.com/Support/Drivers&Tools.php>.
- 4) Setup communication software. Start Tera Term. Click on the menu “Setup -> Serial port” to bring up serial port setup window (see figures below).

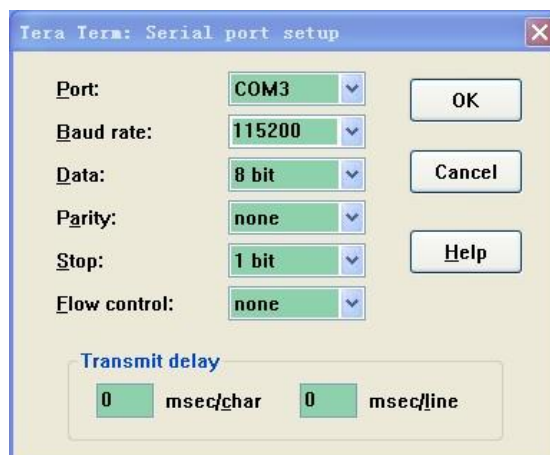
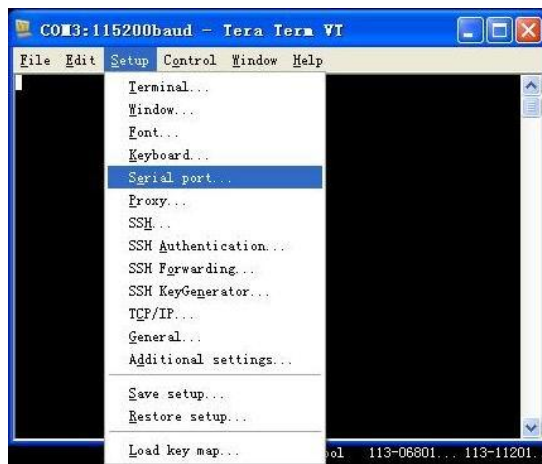

Select the port that is corresponding to DSO112A (you can identify it by going to Windows hardware manager and connecting/disconnecting the USB cable). Set parameters as shown in the figure above.

- 5) Prepare data to be transferred. Capture the waveform you need and put DSO112A in HOLD state so that the captured data will not change. If waveform has been pre-saved to EEPROM use recall function to bring it to screen. Please note that only the waveform that is displayed before entering Menu is transferred.
- 6) Start transfer. To start transfer enter Menu and touch the “Send Data” button. DSO112A will enter sending state waiting for request from PC. This waiting period is about 45 seconds. At Tera Term select “File -> Transfer -> XMODEM -> Receiver” (see figure below). This will open a dialog that allows you to select filename and folder for the coming in data. Remember to name the file with “CSV” extension. If you forget to do so at this moment you can rename it after transfer is finished. Select the option “Checksum” or “CRC” at bottom and keep “Binary” checked. Click the “Open” button. If connection is good you should see transfer finishes in seconds.

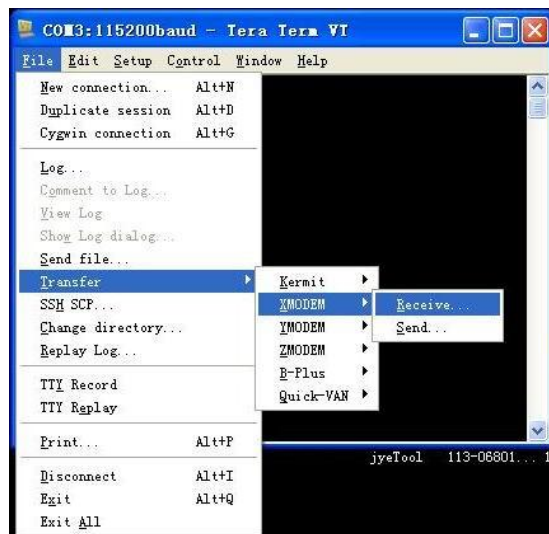

- 7) Verify. Go to the folder where received file was stored and open it with Excel or a text reader.

For the format of waveform data file please see detailed description in Section 5 later.

Restore Factory Default

To restore factory default settings enter Menu and touch the button “Default”. Alternatively, you can do forced factory default restore at power-up by entering Setup state. Please see the subsection “Booting Sequence” in Basic Operations.

Factory default setting values

Parameter	Factory Default Value
Sensitivity	0.5V/Div
Couple	DC
Vertical Position	0
Horizontal Position	80
Timebase	1ms/Div
Trigger Mode	Auto
Trigger Slope	Falling
Trigger Position	1/2
Trigger Level	0V
Trigger Source	Internal
Record Length	512 points
VPos Correction	0
Measurements	All off
Test Signal Frequency	1KHz
Auto Power-off Time	2 minutes

Save/Recall Presets

Presets are groups of oscilloscope settings that are pre-saved in EEPROM. These settings can be recalled to replace existing settings to save setup time. Up to 24 presets can be saved. This is very useful for frequently performed measurements.

To save or recall a preset enter Menu and touch the “Preset” button. The preset screen shows (see figure below). Each row represents a memory location. There are 24 locations available in four pages. Use “<<” and “>>” buttons to navigate through the pages. When a location contains preset the summary of the preset is displayed. An empty location is indicated with “---”.

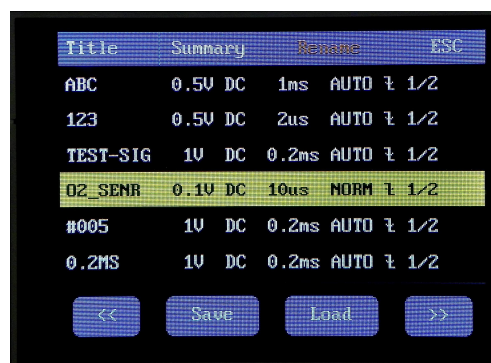

Touch a row to select the location where you want presets be saved to or recalled from. The selected row will be highlighted. Touch “Save” button to save current oscilloscope settings to the location. Please note that the previously saved settings in the selected location will be overwritten without warning. Touch “Load” button to recall the settings that have been previously saved in the selected location. The recalled settings will take

place of current settings and take effect immediately. If the selected location is empty the recall request will be ignored.

Rename Presets

The titles of presets can be renamed for easy remember and identifying. To do this select a preset and touch the button “Rename” at top of screen. The character keypad will show (see below). Type in preset name and finish with the “Done” button. Maximum title string size is 8 characters. Use “BS” (Back Space) button to correct errors.

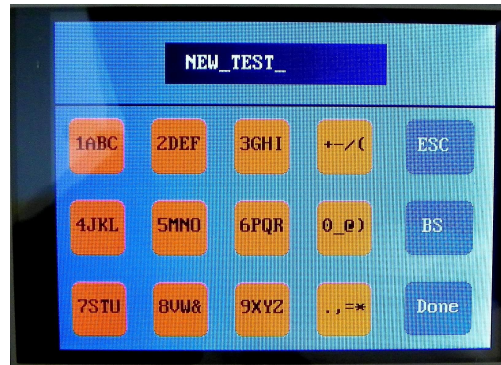

Enter Dashboard

Touch the button “DashBrd” to bring up dashboard. This is an alternative way for quick preset access.

Select Test Signal Frequency

By default the test signal is 1KHz square signal with 3.3V amplitude and 50% duty cycle. The frequency can be selected to be a few pre-set values including 1Hz, 10Hz, 100Hz, 1KHz, 10KHz, 100KHz, 1MHz, and 440Hz. To select different frequency enter Menu and touch the “Test Sig.” button. The Test Signal Frequency screen shows. Select the frequency wanted and touch “Done” button to finish.

- ΔT Cursors** ΔT cursors can be turned on or off by entering Menu and touch the button “ ΔT ”. When the cursors are on the time difference between the two cursors is displayed at the screen top-left corner. This readout changes as cursor position changes.
- To change cursor position first select the cursor you want to move by touching it so as it is highlighted. Then touch any where in screen and scroll horizontally. You should see the selected cursor shifts. De-select the cursor by touching it again or by selecting the other cursor.
- Please note that the unit for ΔT readout is the same as that of current timebase.
- ΔV Cursors** ΔV cursors can be turned on or off by entering Menu and touch the button “ ΔV ”. When the cursors are on the voltage difference between the two cursors is displayed at the screen top-left corner. This readout changes as cursor position changes.
- To change cursor position first select the cursor you want to move by touching it so as it is highlighted. Then touch any where in screen and scroll vertically. You should see the selected cursor shifts. De-select the cursor by touching it again or by selecting the other cursor.
- Please note that the unit for ΔV readout is the same as that of current sensitivity.
- Frequency Measurement** Frequency measurement can be turned on or off by entering Menu and touch the button “Freq”. Frequency readout is displayed at the screen lower-right corner. Please note that frequency measurement is disabled when timebase is set to 50ms/Div or slower because it will cause waveform sampling error due to limited MCU capability.
- Voltage Measurements** Voltage measurements can be turned on or off by entering Menu and touch the button “V”. Voltage measurements include V_{max} , V_{min} , V_{pp} , V_{avr} , and V_{rms} (true RMS) of captured waveform. The readouts are displayed at the screen lower-left corner. Please note that voltage measurements are disabled when timebase is set to 50ms/Div or slower because it will cause waveform sampling error due to limited MCU capability.
- Change Auto-off Time** To change auto power-off time enter Menu and touch “More>>” at screen top-right corner and then touch the button “Auto Off”. This brings up the “Auto Power-off Time” screen. Auto power-off time can be set to 2, 5, 15, 30, 60 minutes or Never. If there is no screen touch activity detected within the time period the oscilloscope will shut down itself. However, if external power supply (USB) is used the auto power-off timing is disabled. The unit will never shut down itself in this case.

Serial Interface (SI)

Introduction

The Serial Interface (SI) of DSO112A is a serial connection that can output captured data/waveform measurements and take commands to operate the oscilloscope remotely. The connection can be a virtual COM port on USB or LVTTL Uart to another controller. For the latter please refer to the Section “Use as an Integration Module” for more details.

The bit stream format for the SI is **115200 baudrate, 8 data bits, 1 stop bit, and no parity**. This is fixed and can not be changed.

The USB connection is based on a CP2102 Uart-USB bridge inside DSO112A. You need install driver for this bridge on PC if it is the first time to connect to DSO112A. Please go to Silicone Lab website to download the appropriate driver for your system and install it correctly. The web page link is:

http://www.silabs.com/products/mcu/pages/usbtouartbridgevcp_drivers.aspx

Data transferred through the SI are in frames. All frames are with the general format given in the table below.

Offset	Field Name	Size	Value
-1	Sync character	1	0xFE
0	Frame ID	1	
1	Frame Size	2	
3	Payload starts	Variable	

This format observes three rules.

- 1) Frame ID must not be same as the Sync character (0xFE).
- 2) If a byte has the value of 0xFE a 0x00 byte must be inserted right after it in transmission.
- 3) All multi-byte data fields are transferred in little endian order unless otherwise stated.

Output of Captured Data

DSO112A has two working modes. Normally it works in **Standalone Mode** where captured data are displayed on LCD panel as waveform. In situation where captured data are wanted DSO112A can be set **USB Scope Mode**. Under USB Scope mode waveform display on panel will be disabled. All captured data are output through the SI.

To make the oscilloscope enter or exit USB Scope mode certain commands are required. These commands must be sent to the oscilloscope via the SI. All available commands are described in details in the section “Commands and Their Returns” below.

In USB Scope mode the oscilloscope panel will look like the photo below. Touch the “Exit” button to return to standalone mode.

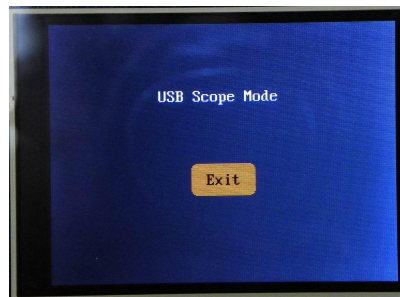

When timebase is set to 20ms/div or faster the oscilloscope will output captured data in blocks of samples. Each block contains the whole buffer of data. The format of output is shown in the table below.

Offset	Field Name	Size	Value
-1	Sync character	1	0xFE
0	Frame ID	1	0xC0
1	Frame Size	2	Record length + 8
3	Data Type	1	0x32
4	Captured data	Record length	Each byte for one sample
RL + 4	Reserved	4	

Because record length can have different values the frame size is variable.

When timebase is set to slower than 20ms/div (i.e. 50ms/div or slower) oscilloscope will output data in single sample. Each frame contains only one sample. The format is shown below.

Offset	Field Name	Size	Value
-1	Sync character	1	0xFE
0	Frame ID	1	0xC0
1	Frame Size	2	8
3	Data Type	1	0x33
4	One sample	1	
5	Reserved	3	

Output of Measurements

Measurements include the voltages (including Vmax, Vmin, Vpp, Vavr, Vrms) and frequency of captured signal. Measurement output from the SI can be enabled or disabled by a specific command. This command is described in details in the section “Commands and Their Returns” below.

Measurement output frame is with the following format.

Offset	Field Name	Size	Value
-1	Sync character	1	0xFE
0	Frame ID	1	0xC0
1	Frame Size	2	0x1E (30)
3	Data type	1	0x34
4	Voltage base unit (VBU) in uV	1	0x14 (20)
5	Reserved	1	0x00
6	Voltage resolution in VBU	2	Sensitivity dependant
8	Vmax	2	
10	Vmin	2	
12	Vpp	2	
14	Vavr	2	
16	Vrms	2	
18	Reserved	2	
20	Frequency	4	
24	Reserved	6	

All voltages are expressed in 16-bit signed integer. Frequency is expressed in 32-bit unsigned integer.

How to Determine True Voltage

Please note that the byte at offset 4 is called “Voltage Base Unit (VBU)”. It is a constant number in unit of uV and the value is 20, representing 20uV. The half-word at offset 6 is called Voltage Resolution (VR), representing voltage per LSB in the voltage measurements. The value of voltage resolution depends on sensitivity that was used to capture the data. To calculate true voltage the following formula can be used:

$$V = \text{Measurement} * VR * 20 \text{ (uV)}$$

For example, when sensitivity is set to 2mV/Div the corresponding VR is 4. If Vmax = 100 this means true maximum voltage is

$$100 * 4 * 20 = 8000 \text{ (uV)} = 8\text{mV}$$

If sensitivity is set 0.5V/Div the corresponding VR is 1000. The same measurement value (i.e. 100) represents

$$100 * 1000 * 20 = 2000000 \text{ (uV)} = 2\text{V}$$

Commands and Their Returns

This section lists all available SI commands. These commands can be sent to DSO112A through virtual COM port on USB or direct LVTTTL connection at J11.

Query

Function: General query to determine oscilloscope type

Format:

Offset	Field Name	Size	Value
-1	Sync character	1	0xFE
0	Frame ID	1	0xE0
1	Frame Size	2	4
3	Reserved	1	0x00

Return: DSO112A will return the following frame.

Offset	Field Name	Size	Value
-1	Sync character	1	0xFE
0	Frame ID	1	0xE2
1	Frame Size	2	14
3	Device type	1	'O' (for DSO)
4	Model	1	5 (for 112A)
5	Description	1	'D'
6		1	'S'
7		1	'O'
8		1	'1'
9		1	'1'
10		1	'2'
11		1	'A'
12	End of string	1	0x00
13	Reserved	1	0x00

Connect

Function: Set DSO112A to USB Scope mode

Format:

Offset	Field Name	Size	Value
-1	Sync character	1	0xFE
0	Frame ID	1	0xE1
1	Frame Size	2	4
3	Command byte	1	0xC0

Return:

Offset	Field Name	Size	Value
-1	Sync character	1	0xFE
0	Frame ID	1	0xE2
1	Frame Size	2	14
3	Device type	1	'O' (for DSO)
4	Model	1	5 (for 112A)
5	Description	1	'D'
6		1	'S'
7		1	'O'
8		1	'1'
9		1	'1'
10		1	'2'
11		1	'A'
12	End of string	1	0x00
13	Reserved	1	0x00

Remarks: After received this command DSO112A will return the same device information as in Query command and enter USB Scope mode.

Disconnect

Function: Set DSO112A back to Standalone mode

Format:

Offset	Field Name	Size	Value
-1	Sync character	1	0xFE
0	Frame ID	1	0xE9
1	Frame Size	2	4
3	Reserved	1	0x00

Return: None

Remarks: After received this command DSO112A will go back to standalone mode.

Note: Alternatively touch the "Exit" button on panel will also make DSO112A exit USB Scope mode and back to standalone mode.

Get Configuration

Function: Read the ranges of parameters used in DSO112A

Format:

Offset	Field Name	Size	Value
-1	Sync character	1	0xFE
0	Frame ID	1	0xC0
1	Frame Size	2	4
3	Sub Command	1	0x20

Return:

Offset	Field Name	Size	Value
-1	Sync character	1	0xFE
0	Frame ID	1	0xC0
1	Frame Size	2	50
3	Device type	1	0x30 (for configuration)
4	VSenMax	1	
5	VSenMin	1	
6	CplMax	1	
7	CplMin	1	
8	VPosMax	2	
10	VPosMin	2	
12	Reserved	8	
20	TBMax	1	
21	TBMin	1	
22	Reserved	4	
26	TrigModeMax	1	
27	TrigModeMin	1	
28	TrigSlopeMax	1	
29	TrigSlopeMin	1	
30	TrigLvlMax	2	
32	TrigLvlMin	2	
34	TrigPosMax	1	
35	TrigPosMin	1	
36	TrigSrcMax	1	
37	TrigSrcMin	1	
38	Reserved	4	
42	RecLenMax	4	
46	RecLenMin	4	

Remarks:

Get Parameters

Function: Read the current parameters from DSO112A

Format:

Offset	Field Name	Size	Value
-1	Sync character	1	0xFE
0	Frame ID	1	0xC0
1	Frame Size	2	4
3	Sub Command	1	0x21

Return:

Offset	Field Name	Size	Value
-1	Sync character	1	0xFE
0	Frame ID	1	0xC0
1	Frame Size	2	34
3	Sub command	1	0x31 (for parameters)
4	VSen	1	
5	Cpl	1	
6	VPos	2	
8	Reserved	4	
12	Timebase	1	
13	Reserved	3	
16	TrigMode	1	
17	TrigSlope	1	
18	TrigLvl	2	
20	TrigPos	1	
21	TrigSrc	1	
22	Reserved	1	
23	Measurements	1	
24	Record Length	4	
28	Reserved	2	
30	HPos	4	

Remarks:

Set Parameters

Function: Set parameters to DSO112A. Newly set parameters take effect at next round capture.

Format:

Offset	Field Name	Size	Value
-1	Sync character	1	0xFE
0	Frame ID	1	0xC0
1	Frame Size	2	34
3	Sub command	1	0x22
4	VSen	1	
5	Cpl	1	
6	VPos	2	
8	Reserved	4	
12	Timebase	1	
13	Reserved	3	
16	TrigMode	1	
17	TrigSlope	1	
18	TrigLvl	2	
20	TrigPos	1	
21	TrigSrc	1	
22	Reserved	1	
23	Measurements	1	
24	Record Length	2	
26	Reserved	4	
30	HPos	2	
32	Reserved	2	

Return:

Special Command

Function: Turn measurements on/off, restore factory default, perform VPos alignment., and save/recall presets.

Format:

Offset	Field Name	Size	Value
-1	Sync character	1	0xFE
0	Frame ID	1	0xC0
1	Frame Size	2	6
3	Sub Command	1	0x24
4	CtrlByte	1	
5	Measurement	1	
6	Preset	1	

CtrlByte:

Bit[7]: 1 – Perform VPos alignment.. 0 – No effect

Bit[6]: 1 – Restore factory default. 0 – No effect.

Bit[5]: 1 – Execute preset save or recall depending on the preset byte at offset 6 (see below).

Bit[4:0]: Reserved. Must be 0b00000.

Measurement:

Bit[7]: ΔT cursor control. 1 – ON. 0 – OFF.

Bit[6]: ΔV cursor control. 1 – ON. 0 – OFF.

Bit[5]: Voltage measurements control. 1 – ON. 0 – OFF.

Bit[4]: Frequency measurement control. 1 – ON. 0 – OFF.

Bit[3:1]: Reserved. Must 0b000.

Bit[0]: Measurement output. 1 – Send measurements to serial port. 0 --- Do not send measurements.

Preset:

Bit[7]: 1 – Recall the preset specified by Bit[6:0]. 0 – Load the preset specified by Bit[6:0].

Bit[6:0]: Index to the location where preset is to be recalled or saved. Valid range is 0 – 23.

CSV Waveform File Format

CSV file is a type of text file. It can be opened by Excel or any text reader. This file is composed of LINES (“Records”) that are terminated by ‘new line’ character (0x0A, ‘LF’). Each line is composed of fields. Fields are usually delimited by commas. Each field is an ASCII coded string or a null string.

Header

The CSV waveform file of DSO112A consists of a 16-line file header and multiple lines of data. The header contains device information and parameters for the samples that follow. The meanings of header lines and their fields are defined below.

Line 1:

Field	Definition
1	File ID. Must be “JYDZ” for correct processing by JYE Tech software
2	Data type.
3	Date (optional)
4	Time (optional)
5	Device model (optional)
6	Manufacturer (optional)

Line 2:

Field	Definition
1	Number of fields in line 3 and 4
2	Vertical display resolution
3	Horizontal display resolution

Line 3: Names of corresponding fields in line 4.

Line 4:

Field	Definition
1	Number of channels
2	Record length (bytes)
3	Channel configuration
4	Sample rate (samples/second)
5	Vertical capture resolution (bits)
6	Timebase
7	Horizontal position
8	Trigger mode
9	Trigger slope
10	Trigger level
11	Trigger source
12	Trigger position
13	Trigger sensitivity
14	Timebase (duplication of field 6)

Line 5: Vertical sensitivity

Line 6: Couple

Line 7: Vertical position

Line 8: Vertical position offset

Line 9: Resolution of voltage (volt/LSB) in unit of uV

Line 10: Vertical sensitivity (Duplicate of line 5)

Line 11: Reference. This is the value corresponding to 0V level.

Line 12 – 16: Reserved.

Sample Data

Sample data start from line 17. Each line contains one sample.

Use as Integration Module

DSO112A is also designed to be used as a module that can be integrated to user's systems. Various alternative connectors are provided to make integration simple and easy.

Connectors

This photo shows the connectors which are useful for integration.

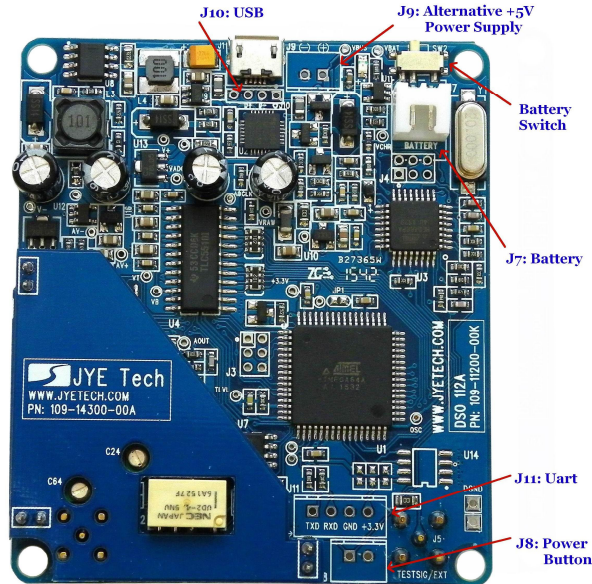

Connector Usage and Pinout

J8: This connector is for relocating power button to a different location.

Pin#	Signal Name	I/O
1	PButton	
2	GND	

J9: This connector is for alternative power supply. The allowed input voltage range is +4.5V – 5.5V.

Pin#	Signal Name	I/O
1	+5V	
2	GND	

J10: This connector is for alternative USB connection.

Pin#	Signal Name	I/O
1	VBUS	
2	D-	
3	D+	
4	GND	

J11: This connector is for alternative UART. It is a LVTTTL connection.

Pin#	Signal Name	I/O
1	TXD	Output
2	RXD	Input
3	GND	
4	+3.3V	

Dimensions

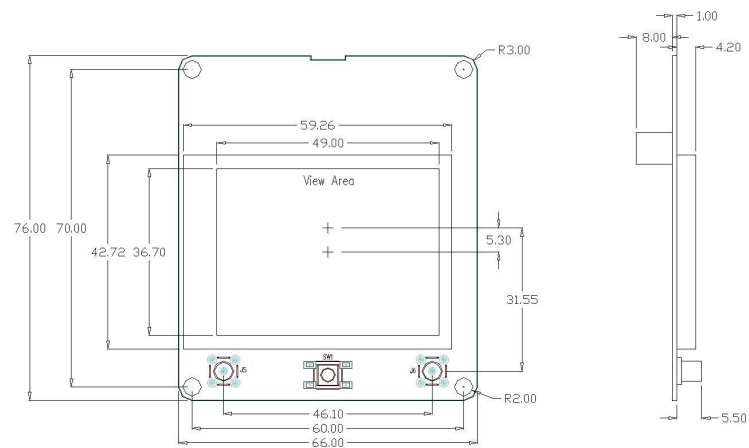
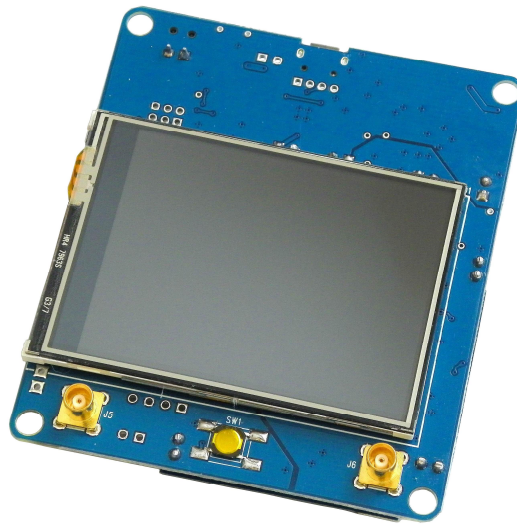

Unit: mm

Maintenance

Charge Battery

DSO112A contains a built-in smart Li-ion battery charger. By connecting the scope to a USB power supply charging will start and a red LED will light up indicating charge is undergoing. The LED can be seen from outside of case (see photo below). Charging will stop automatically when battery is fully charged.

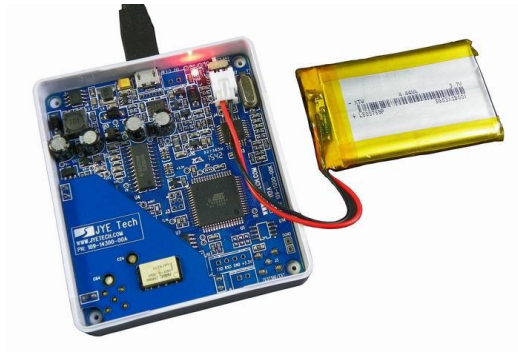

Touch Panel Calibration

The touch panel has been calibrated before shipping. In case of that the touch panel doesn't work properly it can be re-calibrated. Please follow the steps below to perform touch panel calibration (please refer to the section "Booting Sequence")

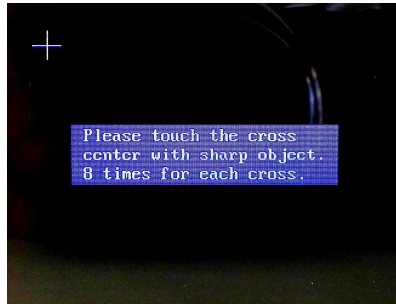

- 1) Power up oscilloscope. At the screen where firmware information is shown press power button to enter Setup state.
- 2) In Setup mode hold down power button for 3 seconds to enter touch panel calibration state as shown in figure above.
- 3) There will be three crosses that appear one after another. Touch the center of each cross 8 times with a pointed object and in much accuracy as you can. Do not touch more than 8 times.
- 4) After finish the third cross you can touch anywhere of screen to verify. You should see a green cross follows where you touched with error less than 2mm. If you see error greater than 2mm re-do the calibration.
- 5) Exit calibration by pressing power button. The oscilloscope will reboot.

Firmware Upgrade

Sometimes you might need to upgrade firmware to acquire new features or higher performance. There are two ways to change the firmware for DSO112A. One is by the pre-installed bootloader. The other is by a programmer.

Upgrade Firmware by Bootloader

- 1) Connect DSO112A oscilloscope to an USB port on PC.
- 2) DSO112A contains a Uart-USB bridge CP2102. If the PC does not have driver for CP2102 installed install the driver first. Please go to the website of Silicone Lab www.silabs.com to download the appropriate driver for your system and install it correctly. You only need to do this once on one computer.
- 3) Get AVRUBD. AVRUBD is a PC application that talks to bootloader to write firmware to MCU. It can be downloaded at <http://www.jyetechnology.com/Products/LcdScope/avrubd.rar>. You only need to do this once on one computer.
- 4) Download the firmware (hex file) you want to write to the scope from JYE Tech website (www.jyetechnology.com) and save it to your computer.

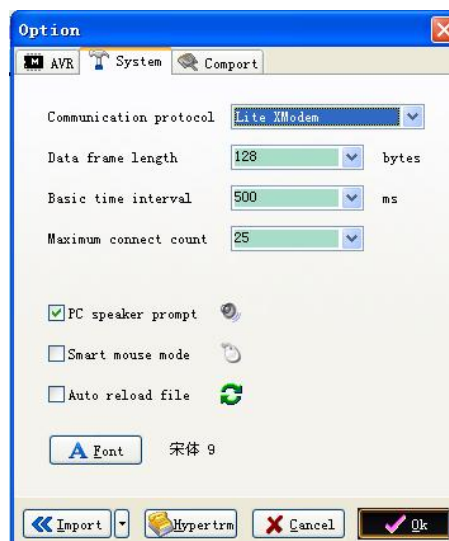
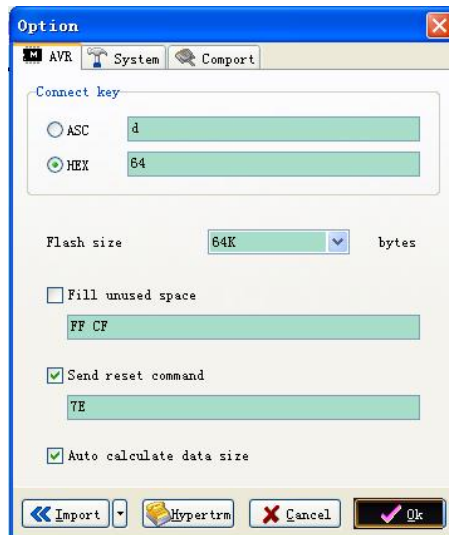

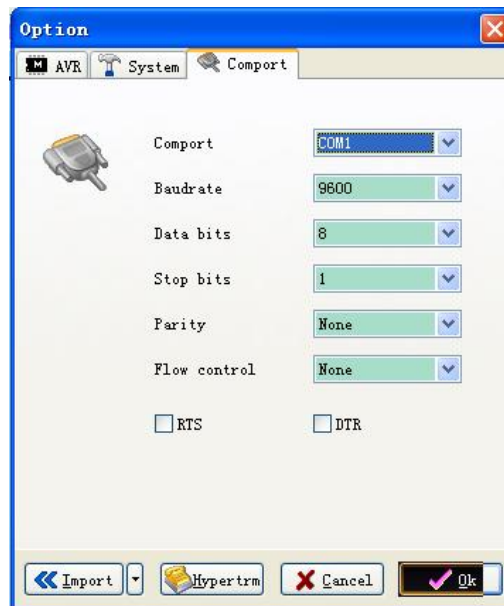

- 5) Start AVRUBD. Click the button “Language” and select “English”.
- 6) Click at “Options” on the main menu. Change settings on the tab “AVR” as shown in figures above. The Connect key has to be set to HEX 64. Flash size should be 64K.
- 7) Change settings on tab “System”. Communications protocol should be set to “Lite Xmodem”. Increase “Maximum connection count” to 100. This will make connection easier.
- 8) Change settings on tab “Com Port”. Com port number should be chosen to the one corresponding to DSO112A. Communication format must be set to **9600 bps, 8N1, no parity and flow control**. Then click OK button.
- 9) Load firmware (hex file) to AVRUBD by clicking “File – Load”.
- 10) Click on “Dn” icon to start writing (see figure below).

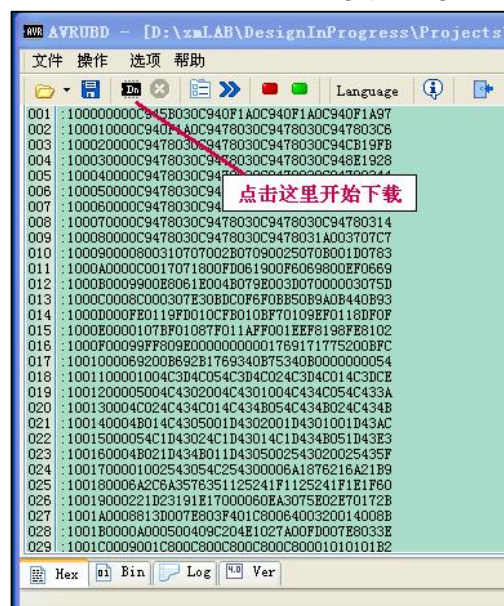

- 11) Right after clicking on the “Dn” icon enter Menu on DSO112A and touch the button “Reboot” immediately. This is to make the oscilloscope enter bootloader.
- 12) You should see AVRUBD communicating with DSO112A. If the communication is successful the firmware writing starts. You can see a progress bar at the lower-right corner of AVRUBD window.
- 13) After the writing finish DSO112A reboots. Firmware upgrading is done.

Upgrade Firmware by Programmer

Firmware can be upgraded by an AVR programmer through programming port J3 on DSO112A main PCB (see photo below). There are many such programmer available on the market (for example, sku# 07302 from JYE Tech). It is important to make sure that the connection between programmer and J3 on DSO112A is correct. The table below describes the signal names on J3.

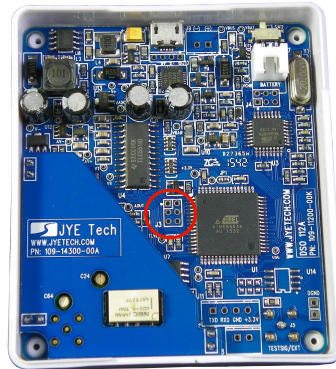

J3 Pin-out Description

Pin#	Signal Name	I/O
1	MISO	O
2	+5V	PWR
3	Sync	I
4	MOSI	I
5	nRST	I
6	GND	PWR

Please do not attempt to change the fuse bits inside the micro-controller. In case these bits are unintentionally changed you need to restore them to the following values.

Extended Fuse Byte: **0b11111111 (0xFF)**

High Fuse Byte: **0b11000000 (0xC0)**

Low Fuse Byte: **0b11010000 (0xD0)**

For detailed descriptions of how to write firmware into micro-controller you need to refer to instructions for the programmer and software you use.

Troubleshooting

Oscilloscope Does Not Turn On

White Screen

Touch Panel No Reaction

Specifications

Vertical	
Number of Channels	One
Analog Bandwidth Range	2MHz
Sensitivity	2mV/Div – 20V/Div
Resolution	8 bits
Input Impedance	1M Ω
Max Input Voltage	50Vpk (for 1X probe)
Couple Range	DC, AC, GND
Horizontal	
Max Real-time Sample	2.5MSPS
Time-base Range	1 μ s/Div – 50s/Div
Record Length	512/1024 points user selectable
Trigger	
Trigger Modes	Auto, Normal, and Single
Trigger Polarity	Rising/Falling
Trigger Source	Internal, External
Trigger position	1/8, 1/4, 1/2, 3/4, or 7/8 of capture buffer
External Trigger Input	0 – 15V
External Trigger Level	0 – 3.3V
Other Features	
Save/recall up to 24 parameter presets	
Save/Recall waveform	
Send Waveform Data as CSV file	
Δ T cursors with readout	
Δ V cursors with readout	
Frequency Measurement with readout	
Voltage Measurements (Vmax, Vmin, Vavr, Vpp, and Vrms) with readouts	
Test Signal with 8 frequency settings	
Serial Data/Control Interface	
Firmware upgradeable via USB	
Auto shutdown when powered by battery	
Display	
Screen	2.4" Color TFT LCD with Touch Panel
Power Supply	
Power Supply Type	3.7V/1200mAh Li-ion Battery or USB
Power Supply Current	< 300mA @ 3.7V
Physical	
Dimension	80mm X 70mm X 18mm

Weight	80 grams (probe not included)
--------	-------------------------------

Appendix A: Coded Values of Oscilloscope Parameters

1) Values of Timebase

Setting	Values
50s/div	0x07
20s/div	0x08
10s/div	0x09
5s/div	0x0A
2s/div	0x0B
1s/div	0x0C
0.5s/div	0x0D
0.2s/div	0x0E
0.1s/div	0x0F
50ms/div	0x10
20ms/div	0x11
10ms/div	0x12
5ms/div	0x13
2ms/div	0x14
1ms/div	0x15
0.5ms/div	0x16
0.2ms/div	0x17
0.1ms/div	0x18
50us/div	0x19
20us/div	0x1A
10us/div	0x1B
5us/div	0x1C
2us/div	0x1E
1us/div	0x1E

2) Values of Trigger Mode

Setting	Values
Auto	0x00
Normal	0x01
Single	0x02

3) Values of Trigger Slope

Setting	Values
Falling	0x00
Rising	0x01

4) Values of Couple

Setting	Values
DC	0x00
AC	0x01
GND	0x02

5) Values of Vertical Sensitivity

Setting	Values
20V/div	0x03
10V/div	0x04
5V/div	0x05
2V/div	0x06
1V/div	0x07
0.5V/div	0x08
0.2V/div	0x09
0.1V/div	0x0A
50mV/div	0x0B
20mV/div	0x0C
10mV/div	0x0D
5mV/div	0x0E
2mV/div	0x0F

Revision History

Version	Date	Summary
v01	2016.01.12	Preliminary release
V02	2016.02.10	<ol style="list-style-type: none"> 1) Added the contents for preset renaming and dashboard. 2) Added description for preset save/recall operation with serial command. 3) Modified description for captured data output of Serial Interface to reflect changes in firmware version 113-11201-211. 4) Modified the values of vertical sensitivity and timebase. These value change was made in 113-11201-211 for future compatibility.